

70...200 MHz Digital Oscilloscope HMO Series 72x...202x

Manual

English

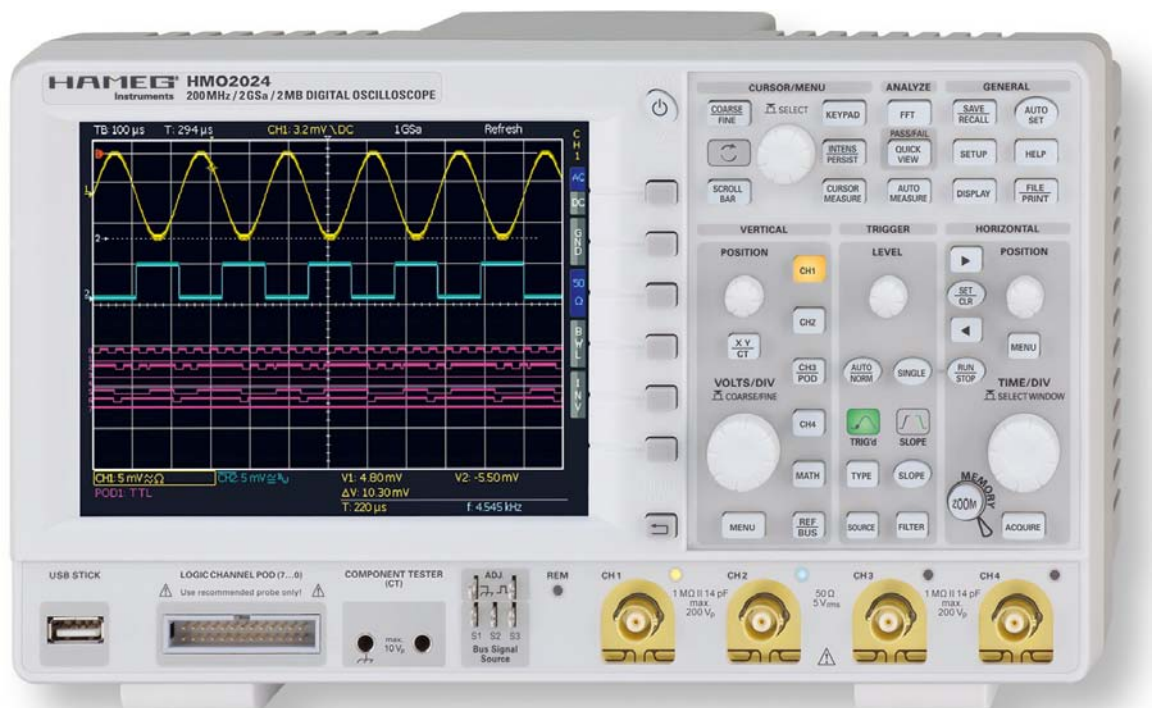



**KONFORMITÄTSERKLÄRUNG
DECLARATION OF CONFORMITY
DECLARATION DE CONFORMITE**

Hersteller HAMEG Instruments GmbH
Manufacturer Industriestraße 6
Fabricant D-63533 Mainhausen

Die HAMEG Instruments GmbH bescheinigt die Konformität für das Produkt
The HAMEG Instruments GmbH declares conformity of the product
HAMEG Instruments GmbH déclare la conformité du produit

Bezeichnung: Oszilloskop
Product name: Oscilloscope
Designation: Oscilloscope

Typ / Type / Type: HMO722/-24, HMO1022/-24,
HMO1522/-24, HMO2022/-24

mit / with / avec: HO720

Optionen / Options / Options: HO730, HO740

mit den folgenden Bestimmungen / with applicable regulations / avec les directives suivantes

EMV Richtlinie 89/336/EWG ergänzt durch 91/263/EWG, 92/31/EWG
EMC Directive 89/336/EEC amended by 91/263/EWG, 92/31/EEC
Directive EMC 89/336/CEE amendée par 91/263/EWG, 92/31/CEE

Niederspannungsrichtlinie 73/23/EWG ergänzt durch 93/68/EWG
Low-Voltage Equipment Directive 73/23/EEC amended by 93/68/EEC
Directive des équipements basse tension 73/23/CEE amendée par 93/68/CEE

Angewendete harmonisierte Normen / Harmonized standards applied
Normes harmonisées utilisées:

Sicherheit / Safety / Sécurité:
EN 61010-1:2001 (IEC 61010-1:2001)

Messkategorie / Measuring category / Catégorie de mesure: I

Überspannungskategorie / Overvoltage category /
Catégorie de surtension: II

Verschmutzungsgrad / Degree of pollution / Degré de pollution: 2

Elektromagnetische Verträglichkeit / Electromagnetic compatibility /
Compatibilité électromagnétique

EN 61326-1/A1 Störaussendung / Radiation / Emission:
Tabelle / table / tableau 4; Klasse / Class / Classe B.

Störfestigkeit / Immunity / Imunité: Tabelle / table / tableau A1.

EN 61000-3-2/A14 Oberschwingungsströme / Harmonic current
emissions Émissions de courant harmonique: Klasse / Class / Classe D.

EN 61000-3-3 Spannungsschwankungen u. Flicker / Voltage
fluctuations and flicker / Fluctuations de tension et du flicker.

Datum / Date / Date
02. 05. 2011

Unterschrift / Signature / Signatur

Holger Asmussen
General Manager

General information regarding the CE marking

HAMEG instruments fulfill the regulations of the EMC directive. The conformity test made by HAMEG is based on the actual generic- and product standards. In cases where different limit values are applicable, HAMEG applies the severer standard. For emission the limits for residential, commercial and light industry are applied. Regarding the immunity (susceptibility) the limits for industrial environment have been used.

The measuring- and data lines of the instrument have much influence on emission and immunity and therefore on meeting the acceptance limits. For different applications the lines and/or cables used may be different. For measurement operation the following hints and conditions regarding emission and immunity should be observed:

1. Data cables

For the connection between instrument interfaces and external devices, (computer, printer etc.) sufficiently screened cables must be used. Without a special instruction in the manual for a reduced cable length, the maximum cable length of a dataline must be less than 3 meters and not be used outside buildings. If an interface has several connectors only one connector must have a connection to a cable.

Basically interconnections must have a double screening. For IEEE-bus purposes the double screened cable HZ72 from HAMEG is suitable.

2. Signal cables

Basically test leads for signal interconnection between test point and instrument should be as short as possible. Without instruction in the manual for a shorter length, signal lines must be less than 3 meters and not be used outside buildings.

Signal lines must be screened (coaxial cable - RG58/U). A proper ground connection is required. In combination with signal generators double screened cables (RG223/U, RG214/U) must be used.

3. Influence on measuring instruments

Under the presence of strong high frequency electric or magnetic fields, even with careful setup of the measuring equipment, influence of such signals is unavoidable.

This will not cause damage or put the instrument out of operation. Small deviations of the measuring value (reading) exceeding the instruments specifications may result from such conditions in individual cases.

4. RF immunity of oscilloscopes.

4.1 Electromagnetic RF field

The influence of electric and magnetic RF fields may become visible (e.g. RF superimposed), if the field intensity is high. In most cases the coupling into the oscilloscope takes place via the device under test, mains/line supply, test leads, control cables and/or radiation. The device under test as well as the oscilloscope may be effected by such fields.

Although the interior of the oscilloscope is screened by the cabinet, direct radiation can occur via the CRT gap. As the bandwidth of each amplifier stage is higher than the total -3dB bandwidth of the oscilloscope, the influence of RF fields of even higher frequencies may be noticeable.

4.2 Electrical fast transients / electrostatic discharge

Electrical fast transient signals (burst) may be coupled into the oscilloscope directly via the mains/line supply, or indirectly via test leads and/or control cables. Due to the high trigger and input sensitivity of the oscilloscopes, such normally high signals may effect the trigger unit and/or may become visible on the TFT, which is unavoidable. These effects can also be caused by direct or indirect electrostatic discharge.

HAMEG Instruments GmbH

0.1	General information regarding the CE marking	2	7	Display of signals	22
			7.1	Display settings	22
0.2	70...200 MHz Digital Oscilloscope HMO Series 72x...202x	4	7.2	Use of the virtual screen area	22
			7.3	Signal intensity and persistence functions	23
			7.4	XY display	23
0.3	Specifications	5	8	Measurements	24
1	Installation and safety instructions	6	8.1	Cursor measurements	24
1.1	Symbols	6	8.2	Auto measurements	25
1.2	Setting up the instrument	6			
1.3	Safety	6	9	Analysis	27
1.4	Correct operation	6	9.1	Quick mathematics	27
1.5	Ambient conditions	6	9.2	Formula editor	27
1.6	Warranty and repair	6	9.3	Frequency analysis (FFT)	28
1.7	Maintenance	7	9.4	Quickview measurements	29
1.8	CAT I	7	9.5	PASS/FAIL test based on masks	29
1.9	Mains voltage	7			
1.10	Product Disposal	7	10	Documentation, storing and recalling	30
1.11	Batteries and rechargeable batteries / cells	7	10.1	Instrument settings	30
			10.2	References	31
2	Familiarize yourself with your new HAMEG Digital Storage Oscilloscope	8	10.3	Curves	31
2.1	Front view	8	10.4	Screenshots	32
2.2	Control panel	8	10.5	Sets of formulas	32
2.3	Screen	9	10.6	Definition of the FILE/PRINT key	33
2.4	Rear view	9	11	Component test	33
2.5	Options	9	11.1	General	33
2.6	General concept of instrument operation	10	11.2	In-circuit tests	34
2.7	Basic settings and integrated help	10			
2.8	Bus Signal Source	11	12	Mixed Signal Operation (optional)	35
2.9	Updates for the instrument settings and interface firmware and the help functions	11	12.1	Logic trigger	35
2.10	Upgrade with software options	12	12.2	Display functions of the logic channels	35
2.11	Self Alignment	12	12.3	Cursor measurements for the logic channels	36
3	A quick introduction	13	13	Serial bus analysis (optional)	37
3.1	Setting up and turning the instrument on	13	13.1	I ² C bus	37
3.2	Connection of a probe and signal capture	13	13.2	I ² C Bus configuration	37
3.3	Display of signal details	13	13.3	I ² C bus triggering	38
3.4	Cursor measurements	14	13.4	SPI bus	38
3.5	Automatic measurements	14	13.5	SPI bus definition	39
3.6	Mathematical functions	15	13.6	SPI bus triggering	39
3.7	Storing data	15	13.7	UART/RS-232 bus	39
			13.8	UART/RS-232 bus definition	40
			13.9	UART/RS-232 bus triggering	40
4	Vertical system	16	14	Remote control via interface	41
4.1	Coupling	16	14.1	RS-232	41
4.2	Sensitivity, Y-Positioning, and Offset	17	14.2	USB	41
4.3	Bandwidth Limit and Signal Inversion	17	14.3	Ethernet (Option HO730)	42
4.4	Probe attenuation selection	17	14.4	IEEE 488.2 / GPIB (Option HO740)	42
4.5	Level setting	17			
4.6	Name a channel	17	15	Appendix	43
5	Horizontal System (Time Base)	18	15.1	List of figures	43
5.1	Capturing modes RUN and STOP	18	15.2	Glossary	43
5.2	Time base adjustments	18			
5.3	Capture modes	18			
5.4	ZOOM function	19			
5.5	Marker function	19			
6	Trigger System	20			
6.1	Trigger modes Auto, Normal, Single	20			
6.2	Trigger sources	21			
6.3	Slope trigger	21			
6.4	Pulse trigger	21			
6.5	Video trigger	22			

200 MHz 2[4] Channel Digital Oscilloscope HMO2022 [HMO2024]

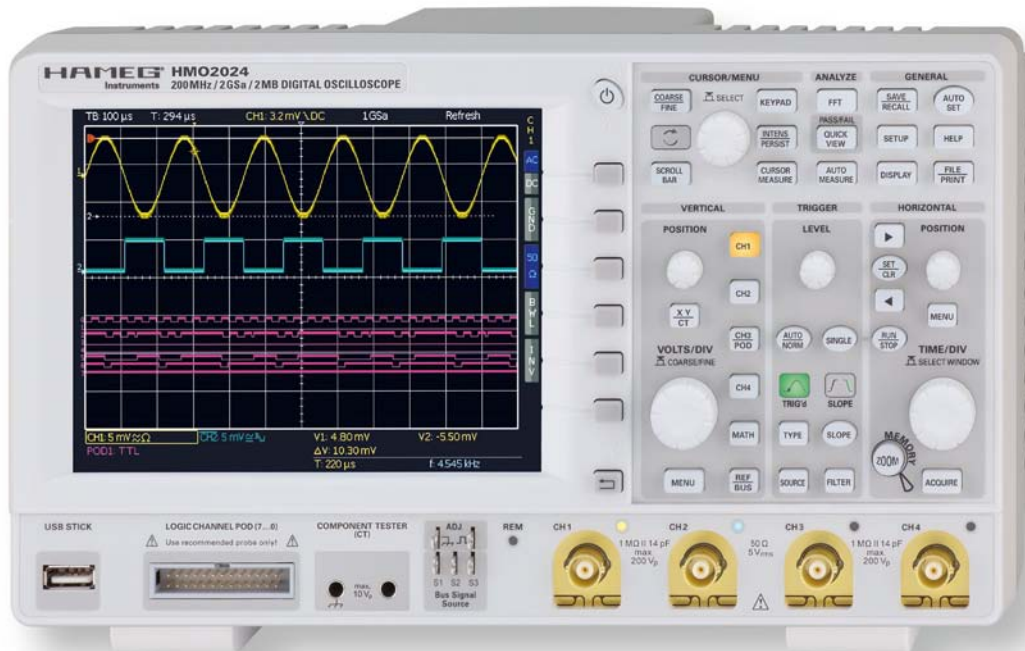

2 Channel Version
HMO2022



Side view



8 Channel
Logic Probe H03508



- ✓ **2GSa/s Real Time, Low Noise Flash A/D Converter (Reference Class)**
- ✓ **2MPts Memory, Memory Zoom up to 50,000:1**
- ✓ **MSO (Mixed Signal Opt. H03508) with 8 Logic Channels**
- ✓ **Serial Bus Trigger and Hardware accelerated Decode, I²C, SPI, UART/RS-232 (Opt. H0010, H0011)**
- ✓ **8 User definable Markers for easy Navigation**
- ✓ **Pass/Fail Test based on Masks**
- ✓ **Vertical Sensitivity 1mV/div., Offset Control ±0.2...±20V**
- ✓ **12div. x-Axis Display Range, 20div. y-Axis Display Range (VirtualScreen)**
- ✓ **Trigger Modes: Slope, Video, Pulswidth, Logic, Delayed, Event**
- ✓ **Component Tester, 6 Digit Counter, Automeasurement, Formula Editor, Ratiocursor, FFT for Spectral Analysis**
- ✓ **Crisp 16.5cm (6.5") TFT VGA Display, DVI Output**
- ✓ **Lowest Noise Fan**
- ✓ **3 x USB for Mass Storage, Printer and Remote Control optional IEEE-488 (GPIB) or Ethernet/USB**

200 MHz 2 [4] Channel Digital Oscilloscope HMO2022 [HMO2024]

All data valid at 23 °C after 30 minute warm-up.

Display

Display:	16.5 cm [6.5"] VGA Color TFT
Resolution:	640 x 480 Pixel
Backlight:	LED 400 cd/m ²
Display area for curves:	
without menu	400 x 600 Pixel [8 x 12 div.]
with menu	400 x 500 Pixel [8 x 10 div.]
Color depth:	256 colors
Intensity steps per trace:	0...31

Vertical System

Channels:	
DSO mode	CH 1, CH 2 [CH 1...CH 4]
MSO mode	CH 1, CH 2, LCH 0...7 (logic channels) [CH 1, CH 2, LCH 0...7, CH4] with Option H03508
Auxiliary input:	Frontside [Rear side]
Function	Ext. Trigger
Impedance	1 MΩ 14 pF ±2 pF
Coupling	DC, AC
Max. input voltage	100V [DC + peak AC]
XYZ-mode:	All analog channels on individual choice
Invert:	CH 1, CH 2 [CH 1...CH 4]
Y-bandwidth [-3 dB]:	200 MHz [5 mV...5V]/div 100 MHz [1 mV, 2mV]/div
Lower AC bandwidth:	2Hz
Bandwidth limiter (switchable):	approx. 20 MHz
Rise time [calculated]:	<1.75 ns
DC gain accuracy	2%
Input sensitivity:	12 calibrated steps
CH 1, CH 2 [CH 1...CH 4]	1 mV/div...5V/div. [1-2-5 Sequence]
Variable	Between calibrated steps
Inputs CH 1, CH 2 [CH 1...CH 4]:	
Impedance	1 MΩ 14 pF ±2 pF [50 Ω switchable]
Coupling	DC, AC, GND
Max. input voltage	200V [DC + peak AC], 50 Ω <5V _{rms}
Measuring circuits:	Measuring Category I [CAT II], UL 61010B-1
Position range	±10 Divs
Offset control:	
1 mV, 2 mV	±0,2V - 10 div. x Sensitivity
5...50 mV	±1V - 10 div. x Sensitivity
100 mV	±2,5V - 10 div. x Sensitivity
200 mV...2V	±40V - 10 div. x Sensitivity
5V	±100V - 10 div. x Sensitivity
Logic channels	With Option H03508
Select. switching thresholds	TTL, CMOS, ECL, User -2...+8V
Impedance	100 kΩ <4 pF
Coupling	DC
Max. input voltage	40V [DC + peak AC]

Triggering

Analog channels:	
Automatic:	Linking of peakdetection and triggerlevel
Min. signal height	0.8 div.; 0.5 div. typ. [1.5 Div at ≤ 2 mV/Div]
Frequency range	5 Hz...250 MHz [5 Hz...120 MHz at ≤ 2 mV/Div]
Level control range	From peak- to peak+
Normal (without peak):	
Min. signal height	0.8 div.; 0.5 div. typ. [1.5 Div at ≤ 2 mV/Div]
Frequency range	0 Hz...250 MHz [0 Hz...120 MHz at ≤ 2 mV/Div]
Level control range	-10...+10 div from center of the screen
Operating modes:	Slope/Video/Logic/Pulses/Busses (optional)
Slope:	Rising, falling, both
Sources:	CH 1, CH 2, Line, Ext., LCH 0...7 [CH 1...CH 4, Line, Ext., LCH 0...7]
Coupling (Analog Channel):	AC: 5 Hz...250 MHz DC: 0...250 MHz HF: 30 kHz...250 MHz LF: 0...5 kHz Noise rejection: switchable
Video:	
Standards	PAL, NTSC, SECAM, PAL-M, SDTV 576i, HDTV 720p, HDTV 1080i, HDTV 1080p
Fields	Field 1, field 2, both
Line	All, selectable line number
Sync. Impulse	Positive, negative

Sources:	CH 1, CH 2, Ext. [CH 1...CH 4]
Logic:	AND, OR, TRUE, FALSE
Sources:	LCH 0...7
State	LCH 0...7 X, H, L
Pulses:	Positive, negative
Modes	equal, unequal, less than, greater than, within/without a range
Range	min. 32 ns, max. 10 s, resolution min. 8 ns
Sources:	CH 1, CH 2, [CH 1...CH 4]
Indicator for trigger action:	LED
Ext. Trigger via:	Auxiliary input 0.3V...10V _{pp}
2nd Trigger:	
Slope:	Rising, falling, both
Min. signal height	0.8 div.; 0.5 div. typ. [1.5 div at ≤ 2 mV/div]
Frequency range	0 Hz...250 MHz [0 Hz...120 MHz at ≤ 2 mV/div]
Level control range	-10...+10 div.
Operating modes:	
after time	32 ns...10 s
after incidence	1...2 ¹⁶
Busses (Opt. H0010):	I ² C/SPI/UART/RS-232
Sources:	CH 1, CH 2, Ext., LCH 0...7 [CH 1...CH 4, Ext., LCH 0...7]
Busses (Opt. H0011):	I ² C/SPI/UART/RS-232
Sources:	CH 1, CH 2, Ext. [for Chip Select at SPI] [CH 1...CH 4, Ext.] [for Chip Select at SPI]
Format	hexadecimal, binary
I ² C	Trigger on Start, Stop, Restart, NACK, Adress (7 or 10 Bit), Data, Address and Data, up to 5 Mb/s
SPI	up to 32 Bit Data, Chip select (CS) pos. or neg., without CS, up to 12,5 Mb/s
UART/RS-232	up to 8 Bit Data, up to 31 Mb/s

Horizontal System

Domain representation:	Time, Frequency [FFT], Voltage [XY]
Representation Time Base:	Main-window, main- and zoom-window
Memory Zoom:	Up to 50,000:1
Accuracy:	50 ppm
Time Base:	2 ns/div...50 s/div.
Roll Mode:	50 ms/div...50 s/div.

Digital Storage

Sampling rate (real time):	2 x 1 GSa/s, 1 x 2 GSa/s [4 x 1 GSa/s, 2 x 2 GSa/s] Logic channels: 8 x 1 GSa/s
Memory:	2 x 1 MPts, 1 x 2 MPts [4 x 1 MPts, 2 x 2 MPts]
Operation modes:	Refresh, Average, Envelope, Peak-Detect Roll: free run/triggered, Filter, HiRes
Resolution (vertical)	8 Bit, (HiRes up to 10 Bit)
Resolution (horizontal)	40 ps
Interpolation:	Sinx/x, linear, Sample-hold
Persistence:	Off, 50 ms...∞
Delay pretrigger:	0...8 Million x (1/samplerate)
posttrigger:	0...2 Million x (1/samplerate)
Display refresh rate:	Up to 2000 waveforms/s
Display:	Dots, vectors, „persistence“
Reference memories:	typ. 10 Traces

Operation/Measuring/Interfaces

Operation:	Menu-driven (multilingual), Autoset, help functions (multilingual)
Save/Recall memories:	typ. 10 complete instrument parameter settings
Frequency counter:	
0.5 Hz...250 MHz	6 Digit resolution
Accuracy	50 ppm
Auto measurements:	Amplitude, standard deviation, V _{pp} , V _{pp+} , V _{pp-} , V _{rms} , V _{avg} , V _{top} , V _{base} , frequency, period, pulse count, t _{width+} , t _{width-} , t _{duty} , t _{duty+} , t _{duty-} , t _{rise} , t _{fall} , pos. edge count, neg. edge count, pos. pulse count, neg. pulse count, trigger frequency, trigger period, phase, delay ΔV, Δt, 1/Δt (f), V to Gnd, Vt related to Trigger point, ratio X and Y, pulse count, peak to peak, peak+, peak-, mean value, RMS value, standard deviation
Cursor measurements:	ΔV, Δt, 1/Δt (f), V to Gnd, Vt related to Trigger point, ratio X and Y, pulse count, peak to peak, peak+, peak-, mean value, RMS value, standard deviation
Interface:	Dual-Interface USB type B/RS-232 (H0720), 2x USB type A (front- and rear side each 1x) max. 100 mA, DVI-D for ext. Monitor
Optional:	IEEE-488 (GPIB) (H0740), Ethernet/USB (H0730)

Display functions	
Marker:	up to 8 user definable marker for easy navigation
VirtualScreen:	virtual Display with 20 div. vertical for all Math-, Logic-, Bus- and Reference Signals
Busdisplay:	up to 2 busses, user definable, parallel or serial busses (option), decode of the bus value in ASCII, binary, decimal or hexadecimal, up to 4 lines
Parallel	logic channels can also be used as source for bus definition
I²C (Opt. H0010, H0011)	color coded Read-, Write Adress, Data, Start, Stop, acknowledge, missing acknowledge, Errors and Trigger condition
SPI (Opt. H0010, H0011)	color coded Data, Start, Stop, Errors and Trigger condition
UART/RS-232 (Opt. H0010, H0011)	color coded Data, Start, Stop, Errors and Trigger condition

Mathematic functions	
Number of formula sets:	5 formula sets with up to 5 formulas each
Sources:	All channels and math. memories
Targets:	Math. memories
Functions:	ADD, SUB, 1/X, ABS, MUL, DIV, SQ, POS, NEG, INV, INTG, DIFF, SQR, MIN, MAX, LOG, LN, Low-, High-pass filter
Display:	Up to 4 math. memories with label

Pass/Fail functions	
Sources:	Analog channels
Type of test:	Mask around a signal, userdefined tolerance
Functions:	Stop, Beep, screen shot (screen print-out) and/or output to printer for pass or fail, event counting up to 4 billion, including the number and the percentage of pass and fail events

General Information	
Component tester	
Test voltage:	10V _p (open) typ.
Test current:	10 mA _p (short) typ.
Test frequency:	50 Hz/200 Hz typ.
Reference Potential:	Ground (safety earth)
Probe ADJ Output:	1 kHz/1 MHz square wave signal -1V _{pp} (t _a <4 ns)
Bus Signal Source	SPI, I ² C, UART, Parallel (4 Bit)
Internal RTC (Realtime clock):	Date and time for stored data
Line voltage:	100...240V, 50...60 Hz, CAT II
Power consumption:	Max. 45 W, typ. 25 W [max. 55 W, typ. 35 W]
Protective system:	Safety class I (EN61010-1)
Operating temperature:	+5...+40 °C
Storage temperature:	-20...+70 °C
Rel. humidity:	5...80% [non condensing]
Dimensions (W x H x D):	285 x 175 x 140 mm
Weight:	<2.5kg

Accessories supplied: Line cord, Operating manual, 2 [4] Probes, 10:1 with attenuation ID (HZ010), CD	
Recommended accessories:	
H0010	Serial bus trigger and hardware accelerated decode, I ² C, SPI, UART/RS-232 on Logic channels and Analog channels
H0011	Serial bus trigger and hardware accelerated decode, I ² C, SPI, UART/RS-232 on Analog channels
H03508	active 8 Channel Logic Probe
H0730	Dual-Interface Ethernet/USB
H0740	Interface IEEE-488 (GPIB) galvanically isolated
HZ091	4RU 19" Rackmount Kit
HZ090	Carrying Case for protection and transport
HZ020	High Voltage probe 1000:1 (400 MHz)
HZ030	single ended active probe (1 GHz)
HZ050	AC/DC Currentprobe 20A, DC...100kHz
HZ051	AC/DC Currentprobe 1000A, DC...20kHz

Differences within the HMO-series 72x...202x:

Most of the technical data of the HMO series 72x ... 202x are identical. Please find the most important differences at the following table.

unit	bandwidth	vertical settings at 1M0hm	input impedance	offset range
HMO72x	70 MHz	1 mV...10V/Div	1 M0hm	-
HMO102x	100 MHz	1 mV...10V/Div	1 M0hm	-
HMO152x	150 MHz	1 mV...5 V/Div	1 M0hm / 50 0hm	±0,2...±20 V
HMO202x	200 MHz	1 mV...5 V/Div	1 M0hm / 50 0hm	±0,2...±20 V

For the complete and latest technical data of each oscilloscope of the HMO series please look at the website www.hameg.com.

1 Installation and safety instructions

1.1 Setting up the instrument

As you can see from the picture, there are small feet on the bottom which can be folded out. Please make sure you have fully folded out the feet's in order to ensure stability of the instrument..

1.2 Safety

The instrument fulfils the VDE 0411 part 1 regulations for electrical measuring, control and laboratory instruments and was manufactured and tested accordingly. It left the factory in perfect safe condition. Hence it also corresponds to European Standard EN 61010-1 and International Standard IEC 1010-1. In order to maintain this condition and to ensure safe operation the user is required to observe the warnings and other

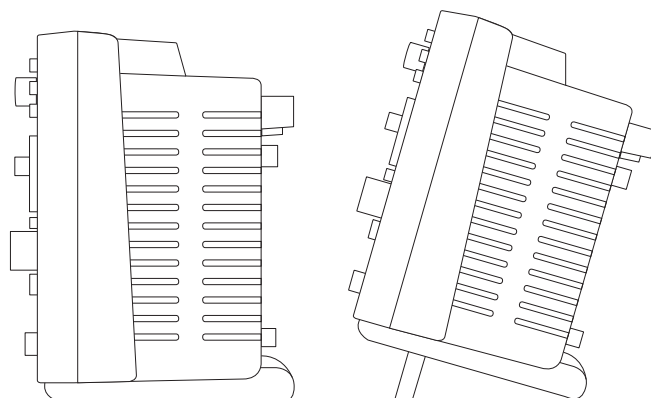

Fig. 1.1: Operating positions

directions for use in this manual. Housing, chassis as well as all measuring terminals are connected to safety ground of the mains. All accessible metal parts were tested against the mains

with 2200V_{DC}. The instrument conforms to safety class I. The oscilloscope may only be operated from mains outlets with a safety ground connector. The mains plug has to be installed prior to connecting any signals. It is prohibited to separate the safety ground connection. If suspected that safe operation may not be guaranteed do not use the instrument any more and lock it away in a secure place.

Safe operation may be endangered if any of the following was noticed:

- in case of visible damage.
- in case loose parts were noticed
- if it does not function any more.
- after prolonged storage under unfavourable conditions (e.g. like in the open or in moist atmosphere).
- after any improper transport (e.g. insufficient packing not conforming to the minimum standards of post, rail or transport firm)

1.3 Correct operation

Please note: This instrument is only destined for use by personnel well instructed and familiar with the dangers of electrical measurements. For safety reasons the oscilloscope may only be operated from mains outlets with safety ground connector. It is prohibited to separate the safety ground connection. The plug must be inserted prior to connecting any signals. The oscilloscope is destined for operation in industrial, business, manufacturing, and domestic sites.

1.4 Ambient conditions

Operating ambient temperature: +5 °C to +40 °C. During transport or storage the temperature may be -20 °C to +70°C. Please note that after exposure to such temperatures or in case of condensation, proper time must be allowed until the instrument has reached the permissible temperature, and until the condensation has evaporated before it may be turned on! Ordinarily this will be the case after 2 hours. The oscilloscope is destined for use in clean and dry environments. Do not operate in dusty or chemically aggressive atmosphere or if there is danger of explosion. The any operating position may be used, however, sufficient ventilation must be ensured. Prolonged operation requires the horizontal or inclined position.



Do not obstruct the ventilation holes!

Specifications are valid after a 30 minute warm-up period at 23 degr. C (tolerance ±2 degr. C). Specifications without tolerances are average values.

1.5 Warranty and repair

HAMEG instruments are subjected to a strict quality control. Prior to leaving the factory, each instrument is burnt in for 10 hours. By intermittent operation during this period almost all defects are detected. Following the burn in, each instrument is tested for function and quality, the specifications are checked in all operating modes; the test gear is calibrated to national standards.

The warranty standards applicable are those of the country in which the instrument was sold. Reclamations should be directed to the dealer.

Only valid in EU countries

In order to speed claims, customers in EU countries may also contact HAMEG directly. Also, after the warranty expired, the HAMEG service will be at your disposal for any repairs.

Return material authorization (RMA):

Prior to returning an instrument to HAMEG, ask for a RMA number either by internet (<http://www.hameg.com>) or fax (+49 (0) 6182 800 501). If you do not have an original shipping carton, you may obtain one by calling the HAMEG service dept (+49 (0) 6182 800 500) or by sending an email to service@hameg.com.

1.6 Maintenance



Before cleaning please make sure the instrument is switched off and disconnected from all power supplies.

Clean the outer case using a dust brush or a soft, lint-free dust cloth at regular intervals.



No part of the instrument should be cleaned by the use of cleaning agents (as f.e. alcohol) as they may adversely affect the labeling, the plastic or lacquered surfaces.

The display can be cleaned using water or a glass cleaner (but not with alcohol or other cleaning agents). Thereafter wipe the surfaces with a dry cloth. No fluid may enter the instrument. Do not use other cleaning agents as they may adversely affect the labels, plastic or lacquered surfaces.

1.7 CAT I

This oscilloscope is destined for measurements in circuits not connected to the mains or only indirectly. Direct measurements, i.e. with a galvanic connection to circuits corresponding to the categories II, III, or IV are prohibited! The measuring circuits are considered not connected to the mains if a suitable isolation transformer fulfilling safety class II is used. Measurements on the mains are also possible if suitable probes like current probes are used which fulfill the safety class II. The measurement category of such probes must be checked and observed. The measurement categories were derived corresponding to the distance from the power station and the transients hence to be expected. Transients are short, very fast voltage or current excursions which may be periodic or not.

Measurement CAT IV: Measurements close to the power station, e.g. on electricity meters

Measurement CAT III: Measurements in the interior of buildings (power distribution installations, mains outlets, motors which are permanently installed).

Measurement CAT II: Measurements in circuits directly connected to the mains (household appliances, power tools etc).

Measurement CAT I: Electronic instruments and circuits which contain circuit breakers or fuses.

1.8 Mains voltage

The instrument has a wide range power supply from 105 to 253V, 50 or 60 Hz ±10%. There is hence no line voltage selector. The line fuse is accessible on the rear panel and part of the line input connector. Prior to exchanging a fuse, the line cord must be pulled out. Exchange is only allowed if the fuse holder is undamaged. It can be taken out using a screwdriver put into the slot. The fuse can be pushed out of its holder and exchanged. The holder with the new fuse can then be pushed back in place against the spring. It is prohibited to "repair" blown fuses or to bridge the fuse. Any damages incurred by such measures will void the warranty.

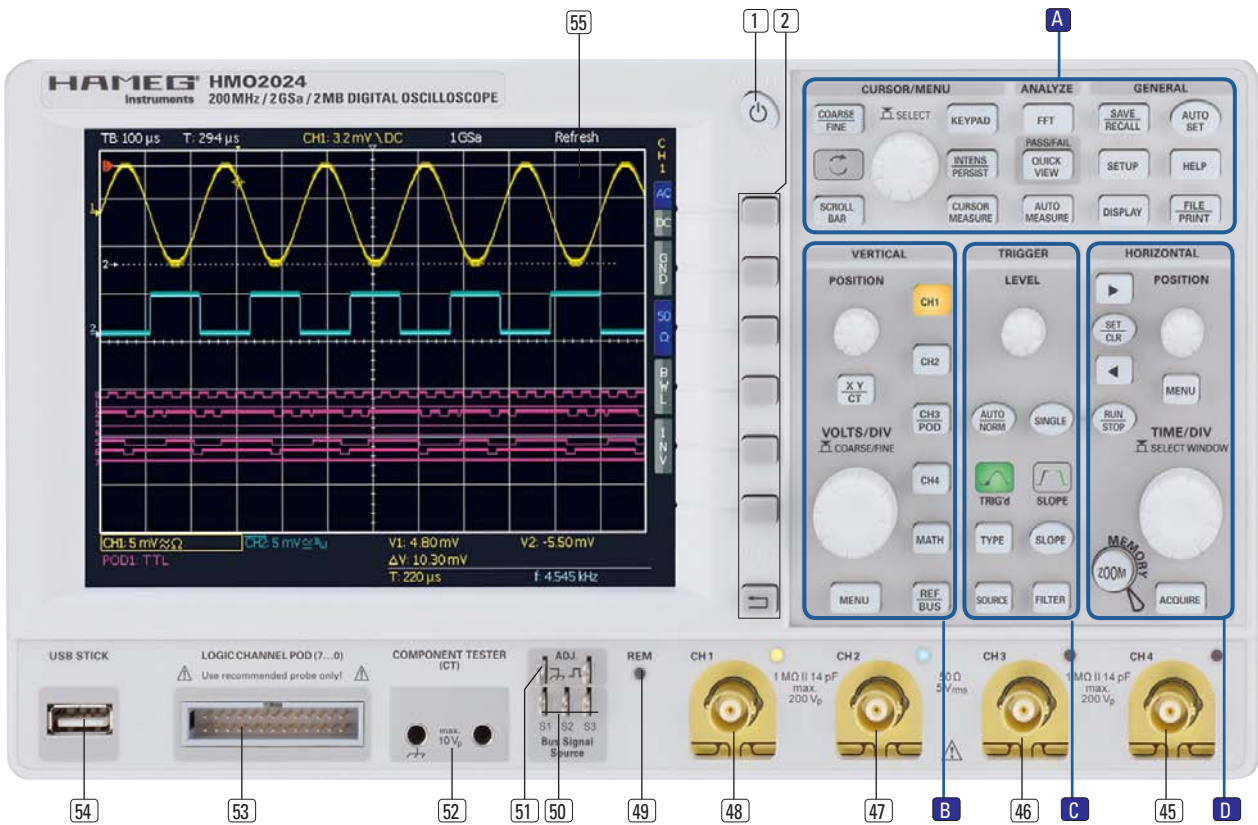

Fig. 2.1: Frontview of the HMO2024

2 Familiarize yourself with your new HAMEG Digital Storage Oscilloscope

2.1 Front view

On the front you find the power key **1**, in order to switch on the instrument or enter stand by mode. If the instrument is in stand by mode, this key light up red. If the scope is switched off using the main power switch on the back, the red light will also switch off. (this will take some seconds) Furthermore you find on the front panel the the control panel **2**, **A B C D**, the BNC connectors of the analog inputs **45** to **48**, the probe adjustment output **51**, the bus signal source **50**, the connectors for the optional logic probe H03508 **53**, a USB port for USB sticks **54**, the TFT screen **55**, **the inputs for the component tester** **52** and the LED **49** for showing activity on the remote interface. At the two channel versions there is the external Trigger and Z-input BNC connector at right side.

Please note, the connector for the active logic probes H03508 **53** are solely for these probe. Connecting anything else could destroy the inputs!

2.2 Control panel

The controls on the front panel allow direct access to the most important functions; all extended functions are available via the menu structure by using the grey soft keys. The power key **1** is clearly set apart by its design. The most important controls are backlitged by coloured LEDs in order to immediately indicate the actual settings. The panel is subdivided in these four areas:

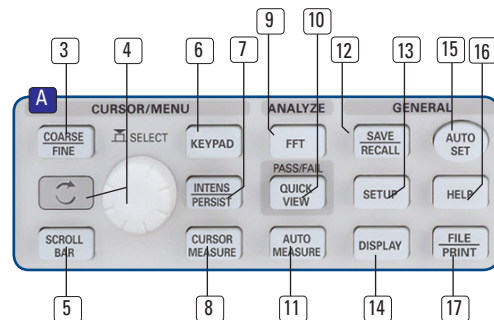

Fig. 2.2: Area A of the control panel.

Area A

This area encompasses these three portions: CURSOR/MENU – ANALYZE – GENERAL.

In the portion CURSOR/MENU you find the cursor functions **8**, the general cursor select and adjustment knob **4**, the Intensity/Persistence key **7**, the key to call a virtual keyboard **6**, **the key for switching between fine and coarse resolution of the universal knob** **3** and the key for the selection of virtual screen **5**.

Please note, if you press the AUTOSSET button **15** longer then 3 seconds, the HMO will be reset to its default settings!

The portion ANALYZE allows direct selection of FFT **9** displays, the Quick-view mode **10** (all important parameters of the actual signal display), and the „Automeasure“ function **11** for the automatic measurement of parameters.

The portion headed GENERAL comprises the following keys: SAVE/RECALL **12** for saving and recalling instrument settings, reference signals, signals, screen displays, and sets of formulae, HELP **16**, DISPLAY **14** for access to the general display

settings, AUTOSET [15], SETUP [13] for access to the general settings (e.g. the language), FILE/PRINT [17].

Area B:

In the area VERTICAL you find all controls of the analog channels such as the position control knob [18], the XY or component tester mode select key [19], the vertical gain adjustment knob [20], the extended menu functions key [21], the channel select keys [22] to [25], (the two-channel version HMO3522 has only [22] [23]) which also serve as the selection keys for the optional logic probes [24] [25]. There are also the mathematics function key [26] and the reference signal settings key [27].

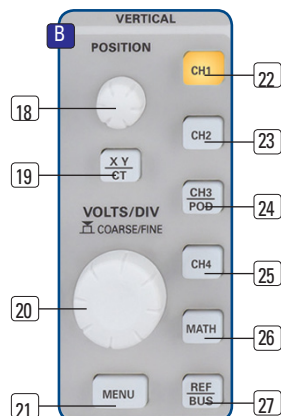

Fig. 2.3: Area B of the control panel.

Area C:

This area TRIGGER of the control panel offers all functions for the adjustment of the trigger level [28], the selection of auto or normal trigger [29], the trigger type [31], the trigger source [32], single sweep [33], the trigger slope [34], the trigger signal filters [36]. In addition, there are status indicators showing whether a signal fulfills the trigger conditions [30] and which slope was selected [34].

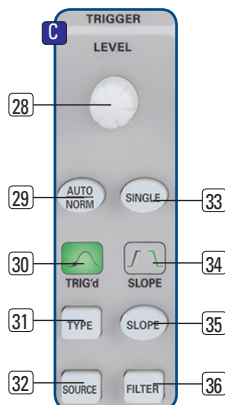

Fig. 2.4: Area C of the control panel

Area D:

The keys [37] [38] [39] on this control panel area HORIZONTAL allow to shift the trigger position horizontally, either step-by-step or using the smaller one of the knobs. The backlit key [39] controls the run or stop modes; the key will light up red in stop mode. The key [40] activates the zoom function, the key [44] the selection of the acquisition modes, the key [42] the access to the time base menus. The knob [43] allows to adjust the time base speed.

To the left of the control panel there are the soft keys [2] which control the menu functions.

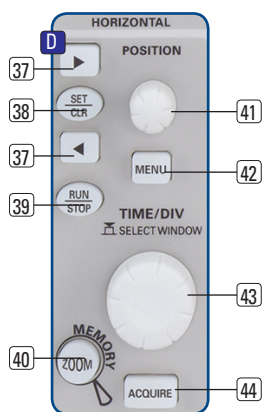

Fig. 2.5: Area D of the control panel

2.3 Screen

The HMO is equipped with a 6.5" (16.5 cm) LED backlit colour TFT display with VGA resolution (640 x 480 pixels). In normal mode (no menus shown) there are 12 divisions in X direction. If menus are shown, this will be reduced to 10 divisions. On the left of the screen area little arrows [1] indicate the reference potentials of the channels. The line above the graticule contains status and settings information such as the time base speed, the trigger delay and other trigger conditions, the actual sampling rate, and the acquisition mode [2]. On the right of the graticule a short menu is shown which contains the most important settings of the channel actually being displayed; these may be selected using the soft keys [3]. Below the graticule, measurement results of parameters and

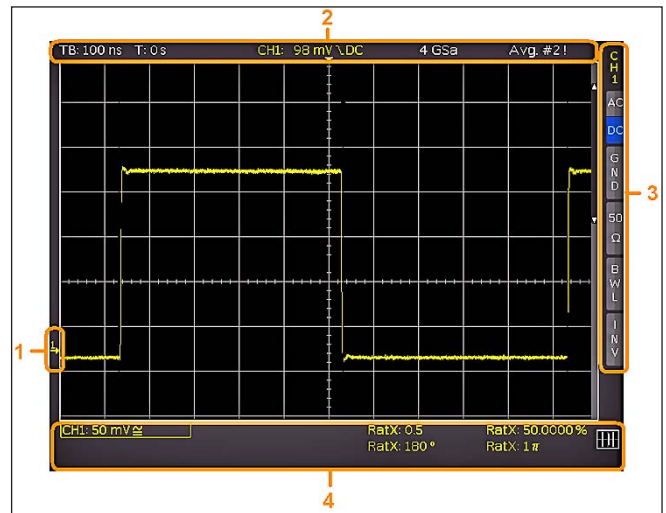

Fig. 2.6: Screen

curators, the settings of the activated vertical channels, of the reference signal, and of the mathematically derived curves [4] are shown. Within the graticule, the signals of the selected channels are displayed. Normally, 8 vertical divisions are shown; it can be virtually extended to 20 divisions which can be displayed using the SCROLL BAR knob [5].

2.4 Rear view

On the rear panel there are the main power switch [1], the receptacle for the interface modules [2] (USB / RS-232, USB/Ethernet, IEEE-488), the standard DVI connector [3] for the connection of external monitors and projectors, the BNC connector for the Y output [4] (of the channel selected for triggering) and the external trigger input [5]. With the two-channel models this connector is located on the front panel.

Also here you can find an additional USB Port [6] and the main power input [7].

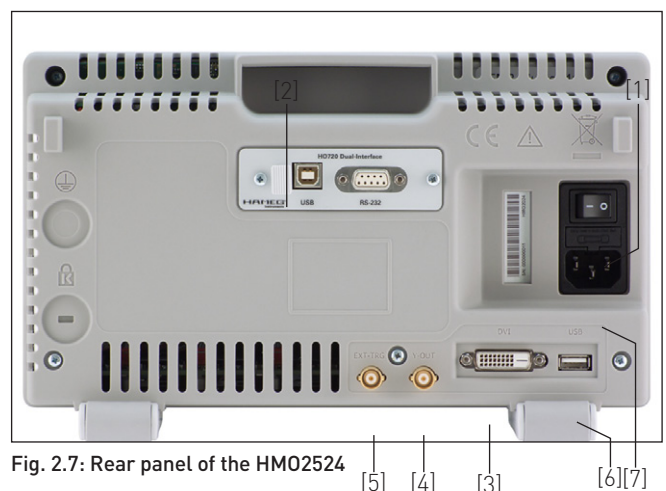

Fig. 2.7: Rear panel of the HMO2524

2.5 Options

The HMO series instruments offer some options which allow you to extend the areas of application considerably. The following interface modules are available and may be installed by the customer in the rear receptacle:

- H0740 (IEEE-488, GPIB, galvanically isolated)
- H0730 (combination of Ethernet and USB with integrated web server)

All HMO series instruments are prepared for mixed-signal operation and have the appropriate connectors on the front panel. Connecting an 8-channel logic probe H03508 equips the

scope with 8 logic channels. Further options are the passive 500 MHz Slimline 10:1 probes of the type HZ355, passive 1000:1 probes with up to 4000V of the type HZO20, active 10:1 probes with <1 pF input capacity of the type HZO30, active difference amplifier probes HZ100, HZ109 and HZ115 with up to 1000 V_{rms} and 40 MHz, the current probes HZO50 and HZO51 with up to 100 kHz bandwidth and up to 1000A, the 19" rack-mount set HZO91 and the type HZO90 transport bag for the protection of the instruments.

The options H0010/11 make the analysis of serial protocols available, more informations you can find in chapter 2.10

2.6 General concept of instrument operation

HAMEG oscilloscopes are renowned for easy operation, based on a few basic principles which repeat with the diverse settings and functions.

- Such keys which do not open a soft menu (e.g. quickview) switch a function on, pushing the key again will switch the function off.
- Such keys which call a specific function (e.g. FFT) which in turn can call or require more settings will activate the function upon the first touch. Pushing the key a second time will call the soft menu (sub menu) for the settings. Pushing the key a third time will deactivate the function.
- Such keys which open a soft menu upon the first touch will close it upon pushing a second time.
- The universal knob is used in the diverse menus either for selecting numbers or submenus and to enter values by pushing. The universal knob in cursor measurement is used for selecting and moving the cursor.
- The key MENU OFF below the soft menu keys closes the present menu or it switches to the next higher level.
- If a channel is deactivated, pushing the respective channel key will switch it on. If a channel was already activated earlier, selecting another channel will change operation to the channel whose key was pushed (its LED lights up). If a channel is already selected, pushing its lighted key will deactivate the channel and select the next channel according to this sequence: CH1 > CH2 > CH3 > CH4.
- The COARSE/FINE key is used to switch between coarse and fine resolution of the universal knob. If the key is light up white, the FINE resolution is active.

The following describes some frequently used navigation elements in the soft menus.

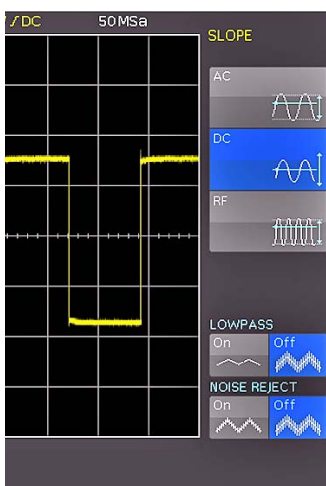

Fig. 2.8: Selection of basic soft menu elements

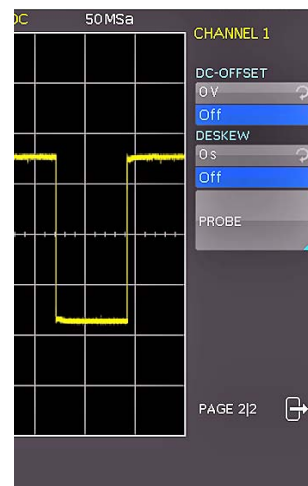

Fig. 2.9: Basic soft menu elements for settings and navigation

In the Fig. 2.8 there are two basic soft menu elements for choosing something are shown. To select from the first three you just need to press the soft key beside and the element is active (shown as blue color). A second kind of selecting is shown on the lower two menu entries. Pressing the respective soft key toggles between the two choices, again the active selection is marked blue.

The menus are used as shown in Fig. 2.9 if they concern functions which have either to be switched on or where values have to be set. The choice is between OFF and the value presented. The round arrow in the right corner of the menu window points to the universal knob which is to be used for selecting the value. If there is a lower menu level, this will be indicated by a small triangle in the right lower corner of the respective menu point.

If there are further pages on the same level, the lowest menu point will be used for navigation. It shows the number of menu pages on this level as well as the activated number of pages. Pushing the respective soft menu key will advance by one page, after the last page the first one will follow.

2.7 Basic settings and integrated help

Basic settings like language for user interface and help, miscellaneous settings and interface settings can be set using the menu which opens after pressing the SETUP key in the GENERAL area of the control panel.

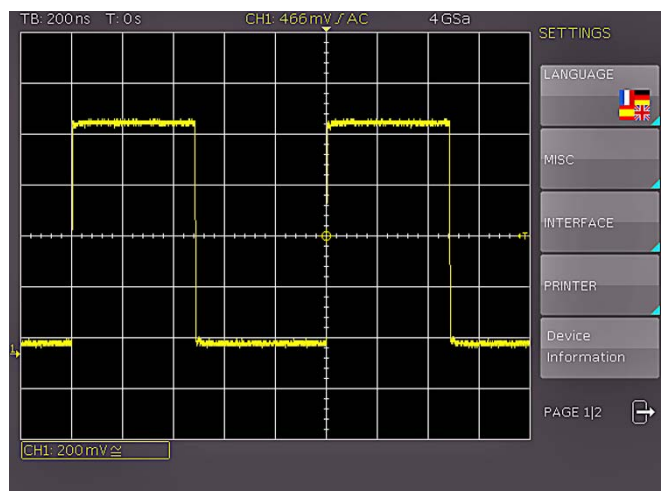

Fig. 2.10: Menu for basic settings

On the first page you can set the user interface and help language by pressing the soft key LANGUAGE and select German or English.

The soft key beside MISC opens a menu with the following selections:

- **MENU OFF** (choose manual or automatic with time limit of 4s up to 30 s for closing soft menus)
- **TIME REFERENCE** (position for reference of the trigger time, choose from -5/DIV up to +5/DIV, 0/DIV is in the middle of the screen and set as standard)
- **DATE & TIME** (opens menu to set date and time)
- **SOUND** (opens menu to set any combination of beep for control, error and/or trigger)
- **DEVICE NAME** (menu to set a name for the HMO2524, maximum of 19 characters are allowed, the name will appear in Screenshot's)
- **HAMEG LOGO IN SCREENSHOT** (here you can setup, whether the HAMEG logo will be inserted into the screenshot or not.)

The next menu entry INTERFACE lets you select the interface you are using (USB and RS-232 are standard) and possible settings for that interface.

The menu item PRINTER contains settings for POSTSCRIPT printers. Pushing this softkey will open a submenu in which you can select the paper format and the colour mode. If you choose the top menu item PAPER FORMAT with the associated soft menu key, a window will open which offers the selection of A4, A5, B5, B6, and Executive. Use the universal knob to select the desired format which will then be indicated on the soft menu key.

The next lower menu item COLOR MODE allows the selection of the modes Greyscale, Color, and Inverted following the same procedure. The Greyscale mode converts a color display to a greyscale display which can be printed on a Black-and-White Postscript printer. The Color Mode will print the display in colour as it is shown on the screen (black background). In the Inverted Mode the color display will be printed in colour with a white background on a color Postscript printer in order to save toner and ink.

The last menu DEVICE INFORMATION open a window with all informations about hard- and softwarestatus of your HMO. You should have these information on hand whenever you have questions about your HMO.

At the second page of the basic menu you find the menu for firmware and help update, which is explained in detail in the next chapter. The last menu item is the PROBE ADJUST. Pressing the soft key leads you to the menu where you can set whether the probe adjust output generates a rectangular signal with 1 kHz or 1 MHz frequency. There is a setting AUTOMATIC which means, that for time base settings up to and including 50 μ s/DIV the probe adjust output is 1 MHz, from 100 μ s/DIV on it is switched to 1 kHz.

The integrated help function can be activated by pressing the key HELP in the GENERAL area of the control panel. A window will open and the text inside is dynamically updated depending on the key (including softmenu key's) you are pushing or the knob you are turning. If you do not need the help anymore, you can switch off the help window by pushing the HELP-key. The backlight of the key and the text window will be switched off.

2.8 Bus Signal Source

The HMO series features 4 contacts left of the channel 1 which provide the following signals according to the respective settings:

- Square wave signal for probe compensation (standard setting), frequency 1 kHz or 1 MHz.
- SPI signal, data rates 100 kbits/s, 250 kbits/s or 1 Mbits/s
- I²C signal, data rates 100 kbits/s, 400 kbits/s or 1 Mbits/s
- UART signal, data rates 9600 bits/s, 115.2 kbits/s or 1 Mbits/s
- parallel stochastic bit pattern, frequency 1 kHz or 1 MHz
- parallel counter signal, frequency 1 kHz or 1 MHz

The contact at the top left is always ground, the signal levels are around 1 V. The following table shows the use of the 4 outputs S1, S2, S3 and (square wave) corresponding to the signal.

Signal	S1	S2	S3	\square
Square wave	no signal	no signal	no signal	Square wave
SPI	Chip select low active	clock, rising edge	data, high active	no signal
I ² C	no signal	clock SCL	data SDA	no signal
UART	no signal	no signal	data	no signal
Pattern	bit 0	bit 1	bit 2	bit 3
Counter	bit 0	bit 1	bit 2	bit 3

Press the key SETUP in the general area of the front panel for entry into the bus signal source menu, select the page 2 and press the soft menu key next to PROBE COMP. Now you can

select the operational mode for the bus signal source. For each mode a picture with the corresponding pattern of signals on the contacts is displayed. Pressing a soft menu key will open a submenu for choosing the speed of the mode selected.

The square wave signal for probe compensation is available with 1 kHz for the low frequency compensation and with 1 MHz for the high frequency compensation, also AUTOMATIC (standard setting) may be selected. In the automatic mode, the output will provide 1 kHz at sweep speeds from 100 μ s/div, at faster sweep speeds 1 MHz will be available.

These signals allow to learn and check the settings for the parallel and optional serial bus analysis.

2.9 Updates for the instrument settings and interface firmware and the help functions

The HMO series is being improved continuously. You are invited to download the most recent firmware under www.hameg.com. Firmware and help are packed into one ZIP data packet. After downloading the ZIP data unpack it into an USB stick's basic directory. Thereupon insert the stick into the USB port of the oscilloscope and push the key SETUP in the GENERAL area of the front panel. Choose page 2 in the menu, if this has not been opened already. Here you shall find the menu item UPDATE. After selecting this menu item a window will open which displays the actual firmware version indicating the version number, the date and build information.

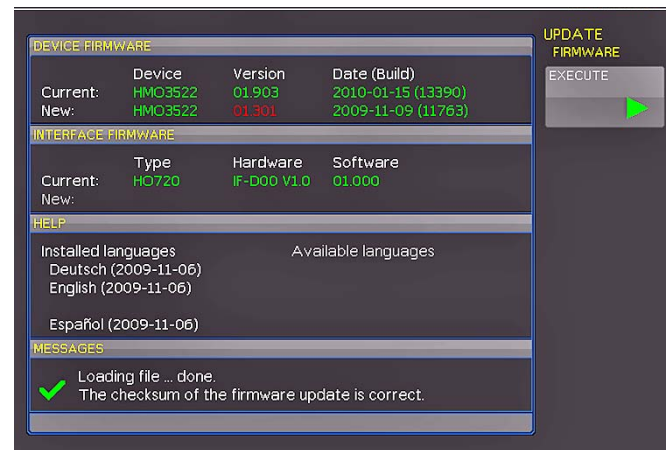

Fig. 2.11: Updating menu and information window

Now choose which to update: the firmware or the help function. If both are to be updated it is recommended to first update the firmware. After you selected firmware updating by pushing the appropriate key the respective date will be searched on the stick, the information of the firmware to be updated from the stick will be displayed below the line NEW. In case the new firmware should be identical to the existing one, the number of the version will be shown in red, otherwise it will be shown in green; only then should you activate the updating by pushing the soft key EXECUTE. If you intend to update the help function or add a help language choose HELP in the updating menu.

The information window will now display the languages installed, the date, and the information about the languages available on the stick. With the soft menu, languages may be added, removed or updated. Please note the format of the date:YYYY-MM-DD according to the multi language norm of ISO 8601.



Fig. 2.12: Updating menu and information window

2.10 Upgrade with software options

The HMO may be upgraded with options which will become accessible after inputting a licence key.

At this time, the options H0010/H0011 is available. The H0010 allows triggering and decoding of the serial buses I²C, SPI, UART/RS-232 on the digital channels (with option H03508) and or the analog channel. The H0011 can only use the analog channel.

The licence key will be sent to you by email as an appended data file (name: SERIAL NUMBER.hlk). This file is an ASCII file and may be opened with an editor, then the true key can be read.

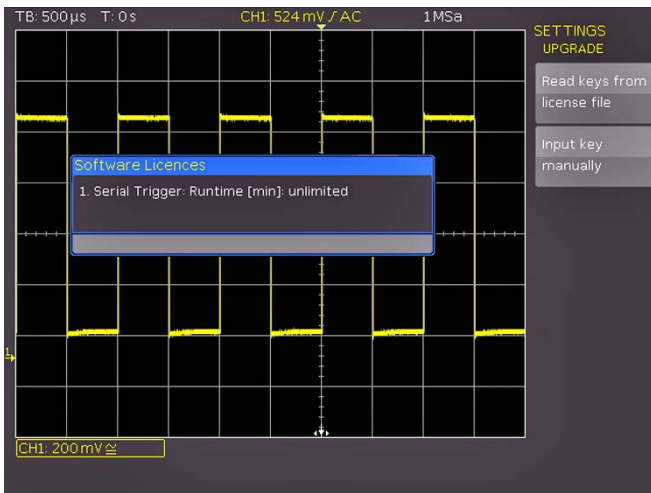

Fig. 2.13: „UPGRADE“ menu.

There are two methods for employing the key to use the desired option: the automatic or the manual input.

The fastest and simplest method is the automatic input: first store the file on an USB memory stick, then install the stick into the front panel FRONT USB port of your HMO and press the key SETUP in the „General“ area of the HMO front panel. The SETUP menu will open. Select page 2 by pressing the respective soft menu key, the following menu will open:

Now open the UPGRADE menu by pressing the respective soft menu key. Then press the soft menu key next to „Read Licence file“ which will open the data manager. Use the universal knob to select the correct file and then press the soft menu key next to LOAD. This will load the licence key; the option will be ready to use immediately after a fresh start of the instrument.

The alternative method is the manual input of the licence key: select the menu UPGRADE and press the soft menu key next

to „Manual key input“. This will open an input window, use the universal knob and the ENTER-key to input the licence key.

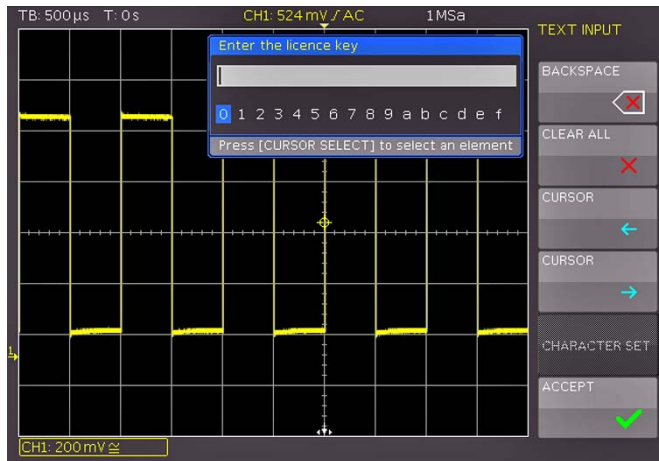

Fig. 2.14: Manual licence key input.

After inputting of the complete key please press the soft menu key next to ACCEPT in order to input the key into the system. The option will be activated after a fresh start of the instrument.

2.11 Self Alignment

The HMO72x...202x series has an internal self alignment in order to achieve highest accuracy possible. During the self alignment procedure the HMO adjust vertical accuracy, offset, timebase and trigger and save the determined correction values internally.



The scope must have achieved operating temperature (switched on for at least 20 min) and all inputs must be without connection, which means all cable and probes must be removed from the inputs.

In order to start the self alignment please press SETUP, go to page 2 and press the softmenubutton SELFALIGNMENT. In the opening menu press START. The procedure will running for about 5-10 minutes in which the steps and progress is displayed using bars. After successful self alignment you will see a information like you can see in figure 2.15 . To leave the self alignment, please press EXIT. You can end the running process with the ABORT button, however this should only be done if, f.e. you have forgotten to remove all probes from the inputs. In any case there should be one self alignment completed.

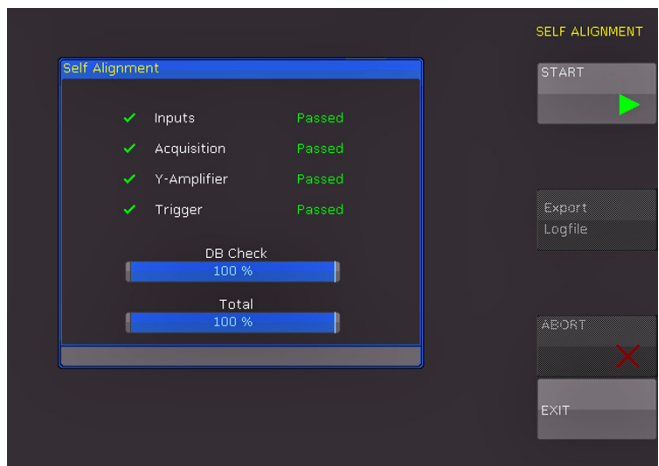

Fig. 2.15: Successful self alignment.

3 A quick introduction

The following chapter is intended to introduce you to the most important functions and settings of your new HAMEG HMO oscilloscope in order to allow you to use the instrument immediately. The internal calibrator signal output is used as the signal source, so you will not need any additional instruments for the first steps.

3.1 Setting up and turning the instrument on

Fold out the feet completely so the display will be inclined slightly upwards. [See chapter 1.2 for positioning] Plug the power cord into the rear panel connector. The instrument will be turned on by switching on the main power switch on the back and pushing the key On/Off [1] on the front panel. After a few seconds the display appears, and the oscilloscope is ready for measurements. Now press the key AUTOSET [15] for at least 3 seconds.

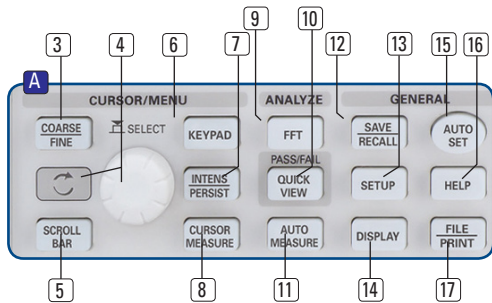

Fig. 3.1: Control panel HMO

3.2 Connection of a probe and signal capture

Take one of the probes delivered with the instrument, detach the protective cap from the top. Apply the compensation box to the BNC connector of channel 1 and turn the black knob CW until it latches positively.

Passive probes be compensated prior to first use. Please refer to the probe manual for the proper compensation procedure. Place the probe in the appropriate position on the ADJ. output such that the tip will be accepted by the hole of the right output while the ground connection is made to the left output, as shown in Fig. 4.3 in chapter 4.

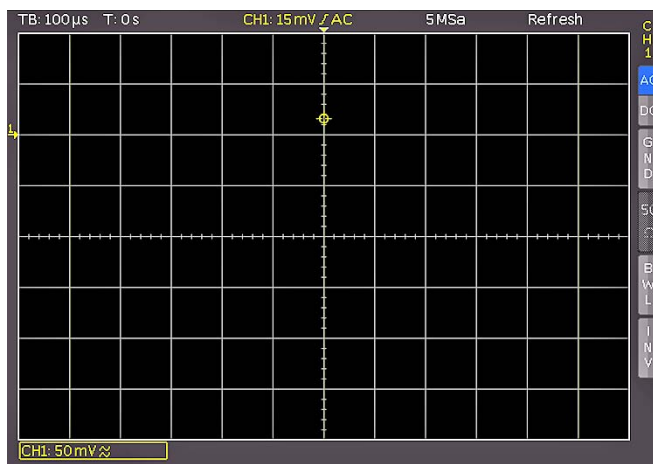

Fig. 3.2: Screen display after connection of the probe

On the right hand side of the screen you will see a short menu of channel 1, the soft keys allow you to select frequently used settings. Press the top soft key once to change the input coupling to DC.

The actual settings are marked by underlying blue fields, repeated pressing of the keys will alternate between the settings.

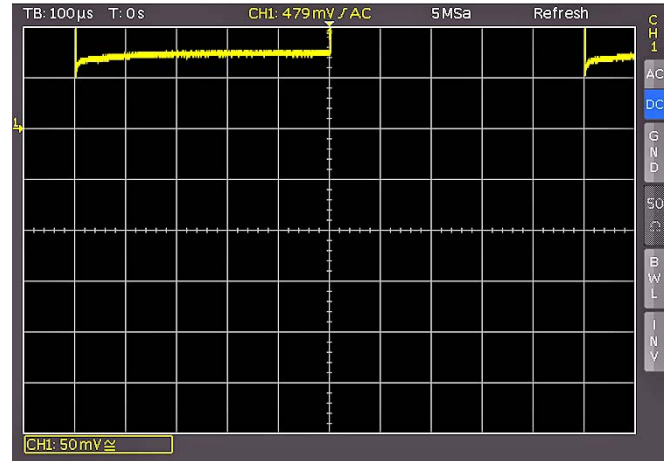

Fig. 3.3: Screen display after changing to DC coupling

Now press the AUTOSET key [15] once shortly, after a few seconds the oscilloscope will have automatically selected appropriate vertical, horizontal time base and trigger settings. You will see now a square wave signal.

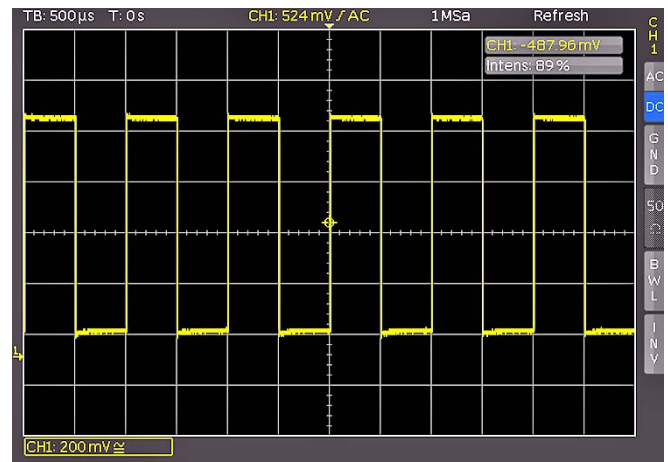

Fig. 3.4: Screen display after Autosetup

3.3 Display of signal details

With the knob [43] you can change the displayed time window: turning it CCW will slow the time base. The memory depth of 2MB per channel allows you to capture wide time windows with high resolution. Continue to turn the knob CCW until you read „TB:5ms“ in the top left corner. Now press the ZOOM key [40].

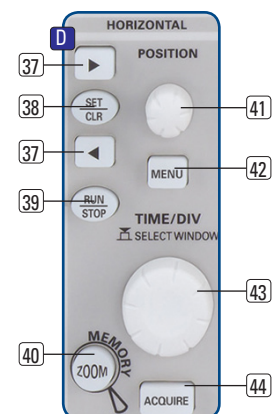

Fig. 3.5: Area of the control panel containing the ZOOM knob

You see now a two-window display: the display will show in the top area the complete captured signal, below an enlarged portion. Use the time base knob to select the zoom factor and the small knob for horizontal positioning.

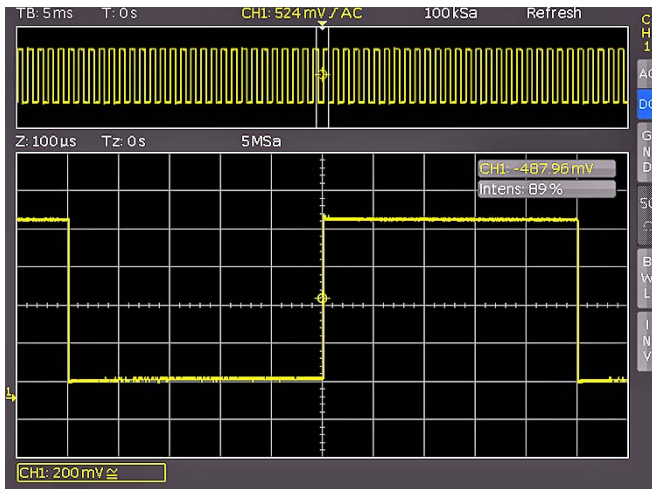

Fig. 3.6: ZOOM function

By pressing the ZOOM key (40) again the zoom mode will be deactivated.

3.4 Cursor measurements

After displaying the signal and its details we now proceed to measuring it using the cursor functions. Press again shortly AUTOSET (15) and then the CURSOR/MEASURE key (8). Now the cursor menu will open up, and you can select the kind of cursor. Press the top soft key in order to open the appropriate menu. Use the knob in the CURSOR/MENU area for the selection by turning it CCW until the V-marker is underlined, press the universal button or wait for some seconds in order to accept the selection. Now two cursors will be displayed along with the signal, and the measurement results in the right bottom area of the screen. Select the active cursor by pushing the universal knob and position it by turning the knob.

The cursor measurement results will be displayed in the left bottom corner of the screen. In this case the „V cursor” has selected the voltages at the two cursor positions, their difference, and the time difference between the positions will be shown. The cursors will be switched off by pressing the CURSORS OFF soft key.

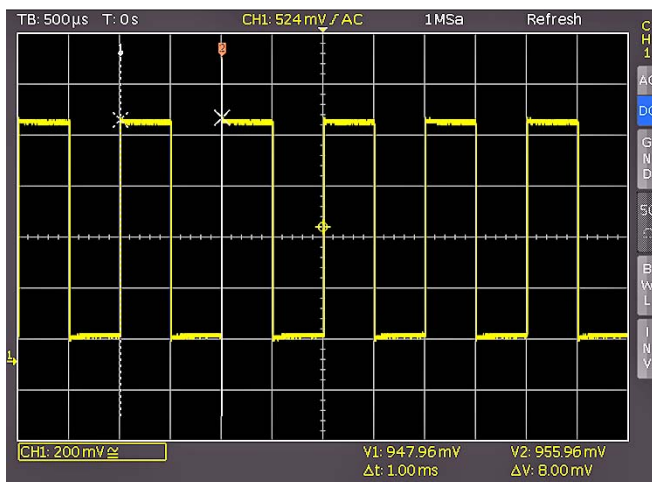

Fig. 3.7: Cursor measurements

3.5 Automatic measurements

In addition to cursor measurements the most important signal parameters can be displayed. Your HAMEG oscilloscope offers these possibilities:

- the definition of the display of 2 parameters which may come from different sources
- a quick view of all important parameters of one source using the QUICK VIEW function.

Please change the time base now to 100µs/div. and press the QUICK VIEW key (10).

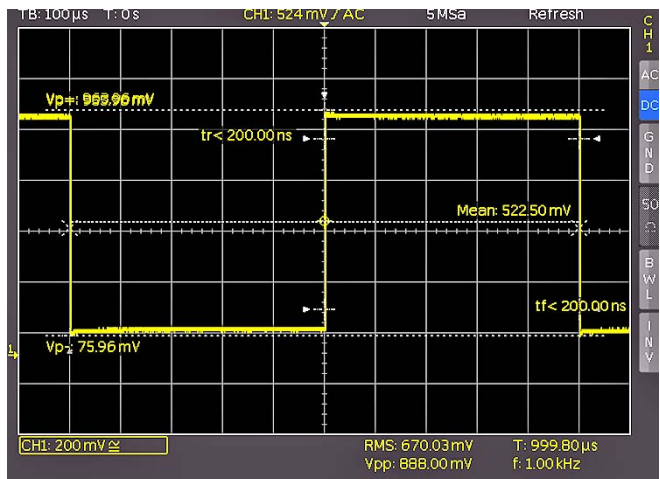

Fig. 3.8: Quick View parameter measurement

Here you see the most important parameters of a signal displayed:

- positive and negative peak voltages
- rise and fall times
- mean voltage

In the right bottom corner of the screen 4 more parameters are shown:

- rms value
- peak-to-peak voltage
- frequency
- period

Thus by simply pressing a key you see 9 parameters at a glance which characterize the signal. This function applies always to the actual active channel.

You may also display two parameters of two different signals. In order to achieve this deactivate the QUICK VIEW function by pressing the key again, then activate channel 2 by pressing the CH2 key. Open the following menu by pressing AUTOMEASURE (11):

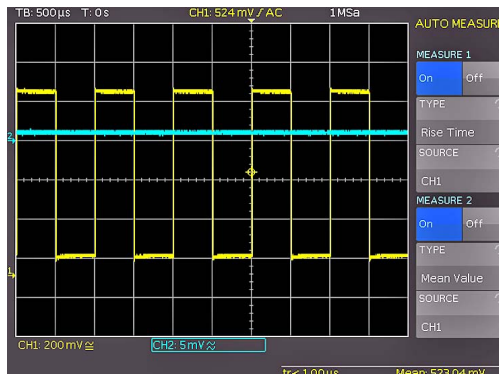

Fig. 3.9: Auto Measure menu

The two parameters are displayed in the right bottom corner of the screen. You may define the parameter measurement using this menu. After switching on MEASURE 1 and MEASURE 2 with the appropriate softkey's the parameter measurements are

displayed in the right bottom corner of the screen. If you press the softkey beside **TYPE** you can choose the parameter you want from the list using the general knob. This procedure is used in all menus where choices are available. Please press the key **TYPE** and choose rise-time.

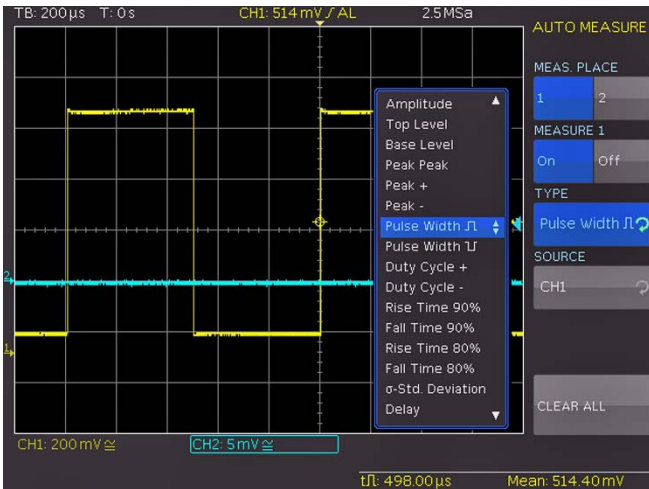

Fig. 3.10: Selection of parameters

Now use soft key next to **Source 2** in order to select this menu item and thus channel 2. Now the rise-time of channel 1 and the mean value of channel 2 are shown. After the menu has been closed, the parameters can be identified by the colours of the respective channels, (here yellow for channel 1 and blue for channel 2.)

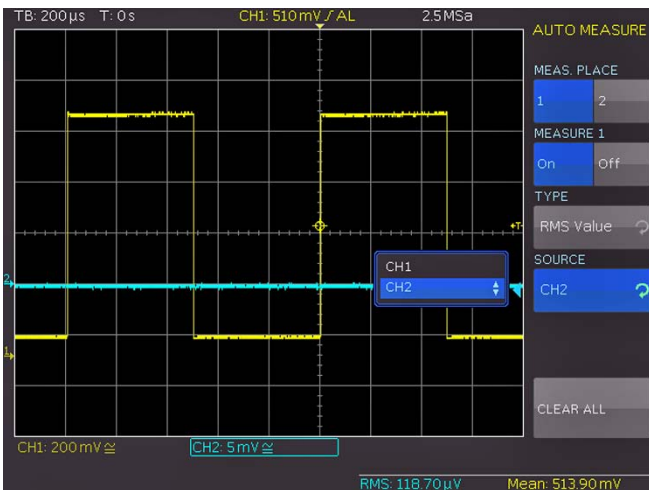

Fig. 3.11: Measuring the parameters of two sources

3.6 Mathematical functions

In addition to cursor and parameter measurements your HMO can also apply mathematical functions to the signals. By pressing the **MATH** key a short menu will open which allows you to select one or two predefined mathematical functions. A quick setting of mathematical functions is possible by selecting the menu item at the bottom. This mode allows you to select the addition or subtraction of two activated sources. The formula editor allows to predefine 5 possible mathematical functions, it is called by pressing the **MATH** key (which lights up red) and the **MENU** key [21].

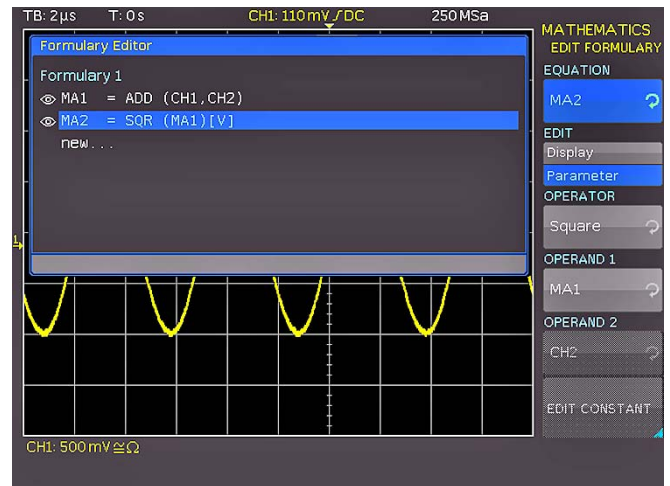

Fig. 3.12: Formula editor

In order to change the settings use the soft keys and the universal knob. Here you can program and store the formulae most used. As mentioned earlier these formulae can be quickly switched on and off by pressing the **MATH** key [26] and using the appropriate short soft menu.

3.7 Storing data

Your HMO can store 5 different kinds of data:

- Instrument settings
- Reference signals
- Signals
- Screen displays
- Sets of formulae

Signals and screen displays can only be stored on USB sticks. All other data can be stored either on a USB stick or in the instrument's non-volatile memories. In order to store data you have to define the kind of data and the destination. First attach a USB stick to the front panel connector. Press **SAVE/RECALL** [12] in order to call the respective menu.

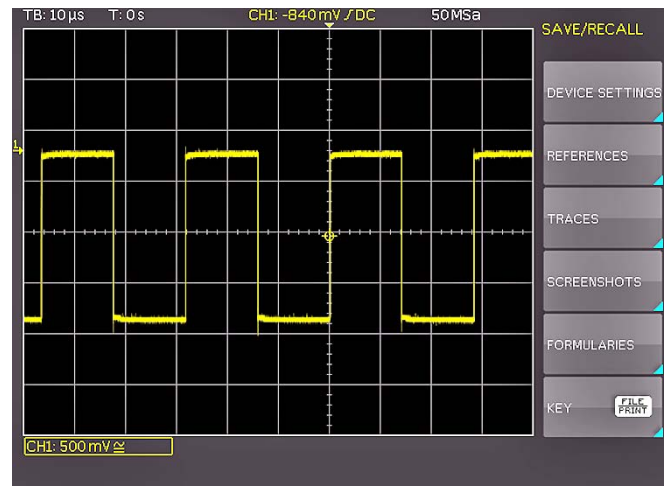

Fig. 3.13: Save/Recall menu

Select the kind of data by pressing the respective soft key (in this example **SCREENSHOTS**) in order to access the settings menu.

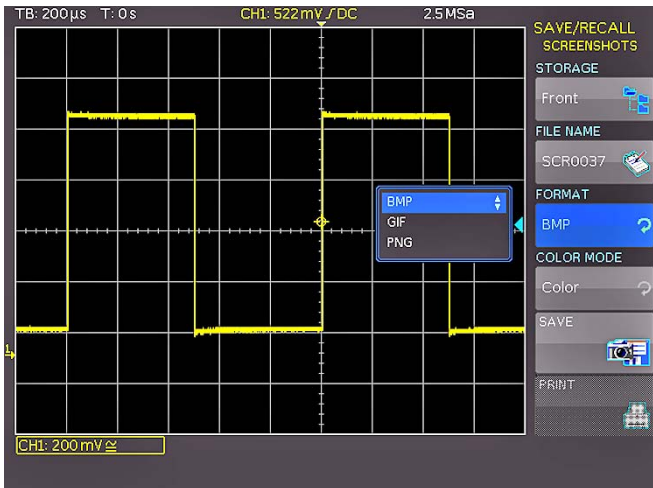

Fig. 3.14: Menu SCREENSHOTS

Please verify that the USB connector into which you plugged the USB stick (front or rear) is written in the top soft menu (You can change the destination by opening the respective menu if you press the softkey next to **STORAGE**). You can now save a Screenshot if you press the softkey next to **SAVE** using the predefined name written in the menu below **FILE NAME**. You may name the destination memory with up to 8 characters; in order to do this select the menu item **FILE NAME** and define the name by using the universal knob (selecting a character by turn the knob and enter by pushing the knob .

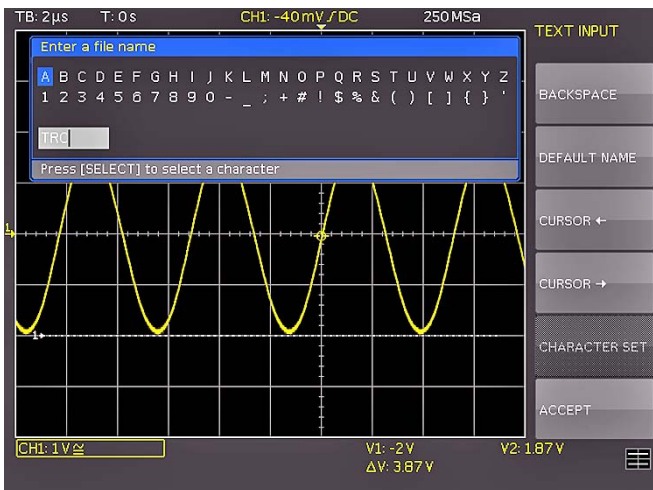

Fig. 3.15: Defining a file name

After the soft key next to **Accept** was pressed the oscilloscope will have stored the name and return to the settings menu. Here you can now store the actual screen display by pressing the **STORE** soft key. Alternatively, you can return to a lower menu level (by pressing the lowest Menu OFF key) and select the menu item key **FILE/PRINT**. In the following menu press the soft menu key next to **SCREENSHOTS**: this will assign the function Screen Shot to the key **FILE/PRINT** with the settings chosen. This enables you to store a bit map file on your USB stick by just pressing **FILE/PRINT** (17) at any time and in any menu.

4 Vertical system

For the vertical settings there are the knobs for the vertical position and the sensitivity, an always visible short menu and an extended menu.

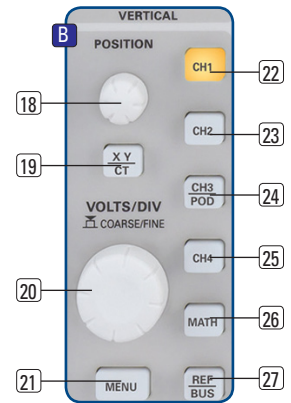

Fig. 4.1: Front panel area with vertical system controls

By pushing the respective key the channel will be selected for which these controls will be activated, this will be indicated by the key lighting up in the color of the channel. Additionally, the channel number on the screen will be framed and displayed lighter than the channels not activated. The appropriate short menu is always visible, the extended menu will be shown upon pushing the key **MENU** (21).

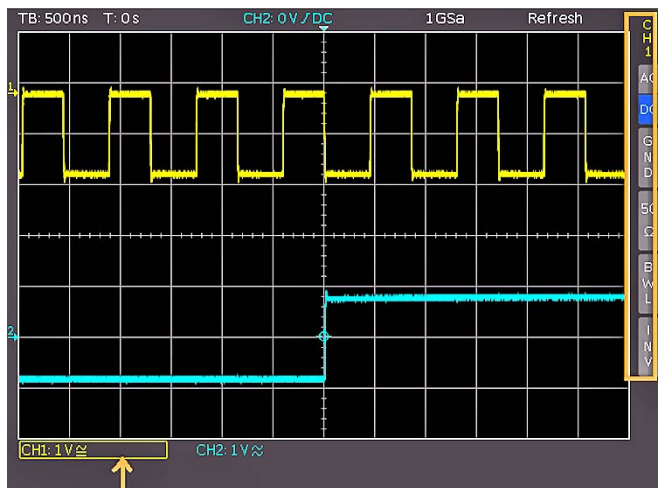

Fig. 4.2: Short menu for the vertical settings

4.1 Coupling

The first item to be selected is the input impedance: 1M Ω or 50 Ω . (only at the HMO152x and HMO202x, the HMO72x and 102x does not offer 50 Ω inputs)

Do not connect the 50 Ω inputs to effective voltage higher than 5 volts!

The 50 Ω input impedance should only be selected if the signal source is 50 Ω , such as a generator with a 50 Ω output where the termination within the scope is to be used. In all other cases 1M Ω is to be selected. Next DC or AC coupling has to be selected: with DC coupling all components of the signal will be displayed, with AC coupling the DC content will be removed, the lower bandwidth is 2Hz. Up to 200V_{rms} may be applied directly to the vertical inputs if 1M Ω is selected. Higher voltages can be measured with probes (up to 40 kV_p). For general applications the probes supplied with the instrument will be used. They are specified for the 1M Ω input. With the HMO72x and HMO102x are the HZ154 delivered, which offer a 10:1 / 1:1 switchable attenuation. Therefore the attenuation

setting must be done manually in the channel menu. The HMO152x and HMO202x are delivered with the HZO10 a 10:1 probe with automatic attenuation read out, which will be read from the probe and factored in.

 **The passive probes must be adjusted to the inputs to which they are connected. See the probe manual for the adjustment procedure. The PROBE ADJUST output is only usable for 1:1 and 10:1 probes, for 100:1 or 1000:1 probes special external generators with a perfect step response have to be used. Please use the shortest possible ground connection.**

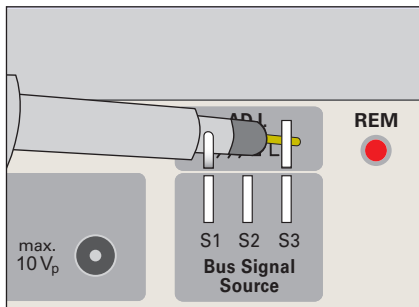

Fig. 4.3: Correct connection of the probe to the probe adjust output

The coupling is selected in the short menu: by just pushing the appropriate key the coupling is chosen, also the signal may be inverted. The menu is valid for the activated channel as indicated by the channel key light up. The channel number will be shown in the top of the menu. By pushing the respective key of another channel the menu will transfer to this channel.

4.2 Sensitivity, Y-Positioning, and Offset

The sensitivity of the analog inputs can be selected with the large knob in the VERTICAL section of the front panel in 1-2-5 steps from 1 mV/div to the respective maximal setting independent of the 50 Ω (only available at the HMO152x and HMO202x) or 1 M Ω selection. The knob is associated with the channel selected by pushing the respective key. The sensitivity can be changed to continuous control by pushing the knob once. The smaller one of the knobs is used for vertical positioning.

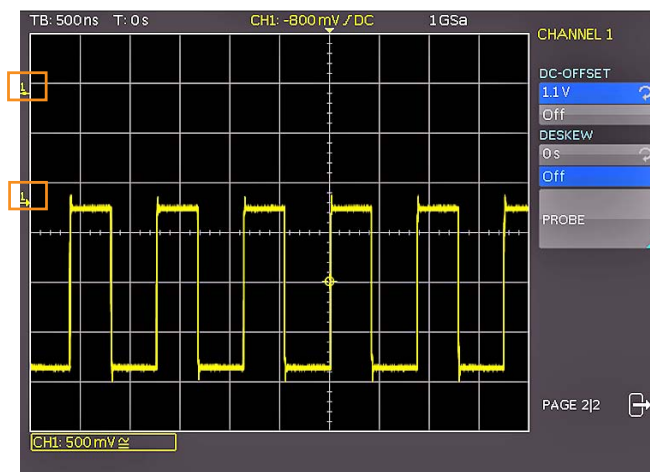

Fig. 4.4: Vertical offset in the extended menu

By pushing the MENU key the extended menu is called. On page 2 of this menu at the HMO152x and HMO202x a DC offset

can be added to the signal. In order to switch this offset in the respective soft key must be pushed. The settings window will be backlit in blue, and the activity indicator next to the general knob will light up; the offset can now be adjusted with the knob. The offset voltage will be added to the signal at the vertical amplifier input offsetting it by that amount from the zero position. The possible amount of offset depends on the Volts/div setting chosen. The offset function being activated will be indicated by two channel markers on the left of the display, also visible if the menu was closed. One marker indicates the position, the other the offset (refer to Fig. 4.4). The offset is individually adjustable for each channel.

Each analog channel may also be shifted in time by ± 15 ns. This adjustment is selected in the same menu and according to the same method as the DC offset; it is used for compensating for the different signal delays of voltage and current probes and different cable lengths.

4.3 Bandwidth Limit and Signal Inversion

An analog 20 MHz low pass can be inserted in the signal path in either the short or extended menu. This will eliminate all higher frequency interference. The filter is activated in the short menu by pushing the respective soft key; the information field will be backlit in blue, **BW** will be displayed in the channel information window.

Signal inversion is available in the short and the extended menu. If it is activated the information field will be backlit in blue, and there will be a bar above the channel number.

4.4 Probe attenuation selection

The HZO10 or optional HZ355 probes are recognized by the instrument which automatically selects the appropriate factor. If any other probe without automatic recognition of the attenuation ratio or just a cable is connected to the instrument, the attenuation factor can be set manually in the extended menu. This is possible for x 1, x 10, x 100 x 1000 or as defined by the user from x 0.001 to x 1000.

In addition you can select the unit Ampere in case you are using a current probe or measure current via a shunt. If you select A the menu shows the most common factors (1V/A, 100mV/A, 10mV/A, 1mV/A). Again you can also select any value between defined by the user. Doing so the measurements are always displayed with the correct unit and scale.

4.5 Level setting

In this menu a level can be set. This level define the treshold for detecting a High or a Low if the analog channel are used as source for the serial bus analysis. After choosing the softmenu, the level can be set by turning the universal knob.

4.6 Name a channel

The last entry at page 2 of the channel menu open a submenu in order to allocate a name for a channel. This name will be shown at the display and at a print out. First of all you can switch on or off the display of the name. Below that softmenu button you find the soft button LIBRARY. After selecting this button you can choose a name from several different suggestions using the universal knob. After pushing NAME you can edit the pre-

chosen name or enter a complete new name using up to 8 characters. This will be done by selecting the character from the virtual keypad using turning the universal knob and selecting by pushing the knob. Pushing the ACCEPT button switch on the name display on the right side of the grid. The name is fixed to the channel and will move over the screen whenever the channel will be moved.

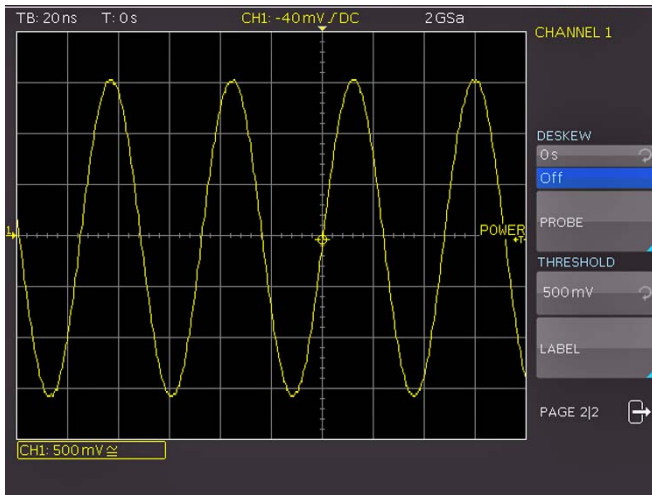

Fig. 4.5: Threshold setting and name allocation

5 Horizontal System (Time Base)

As well as time base settings, the horizontal system comprises the selection of the trigger position, the zoom functions and the available modes of signal capture and the control for the marker function. The knobs are used for the adjustment of the time base speed and the trigger position. The signal capture modes are selected in the respective menus. There is a key provided for activating the zoom function.

5.1 Capturing modes RUN and STOP

The capturing modes can be selected with the key RUN/STOP. In RUN mode signals will be continuously captured; depending on the trigger conditions selected, and displayed, erasing the previously captured ones. If it is desired to store and further analyze a signal and to prevent it being overwritten, capture must be stopped by pushing the RUN/STOP key. While in STOP mode capture is disabled and the key will light up red.

5.2 Time base adjustments

The large knob in the HORIZONTAL section of the control panel is used for the selection of the time base speed. The time base speed is displayed in the upper left hand corner above the graticule. (e.g. „TB:500 ns“) To the right there is the display of the trigger time position with respect to the normal position. The normal trigger position is in the center of the graticule such that 50 % of the signal display is before and 50 % is after this trigger position. The X POSITION knob allows continuous adjustment of the X position. The available maximum values depend on the time base setting. By pushing the key SET/CLR the value will be reset to its reference position. The arrow keys allow you to change the X position by a fixed amount of 5 divisions in the respective direction. If marker function is chosen the arrow keys together with the SET/CLR button are used to navigate through and set/clear marker. The key MENU opens a menu which allows you to set the X position to its minimum and maximum positions or chose the marker function by just a key touch. In addition, there is a submenu **NUMER. INPUT** which allows entry of an arbitrary X position.

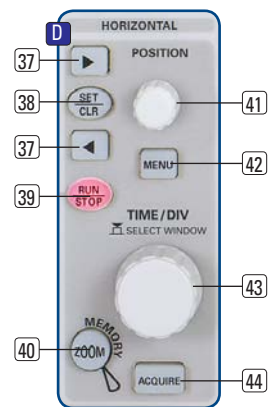

Fig. 5.1: Control panel of the horizontal system

The capture modes are selected by pushing the key ACQUIRE, this opens a display menu which offers the 5 basic modes of capture:

5.3 Capture modes

The capture modes are selected by pushing the key ACQUIRE, this opens a display menu which offers the 5 basic modes of capture:

- **Normal:**
In this mode the signals are captured and displayed.
- **Roll:**
This is a mode especially useful for very slow signals: the signal „rolls“ slowly untriggered from right to left over the screen (signals must be slower than 200 kHz).

- **Envelope:**
In this mode the signal will be displayed as in NORMAL, but its minimum and maximum excursions will also be displayed such that, with time, an envelope of the signal will be displayed.
- **Average:**
Functions only with repetitive signals. The universal knob in the CURSOR/MENU section of the front panel is used to set the number of signal periods for averaging, this is possible in powers of 2 from 2 to 256.
Please note: Averaging reduces the bandwidth.
- **Filter:**
This mode activate a low pass filter with user definable cut off frequency in order to suppress high frequency content. The cut off frequency depends on the sampling frequency. The lowest possible setting is 1/100 of the sampling frequency and the highest possible is 1/4 of the sampling frequency. The setting is done by turning the universal knob.

The second menu page is accessed by pushing the soft key next to the menu „Page 112“, here, extended functions are available:

- **RANDOM SAMPL:**
For very fast signals displayed with the fastest sweep speeds it can be advantageous to switch the instrument to Random Sampling mode; in this mode very many signal periods are used to generate a high resolution picture, provided the signal does not change its shape. This is equivalent to a sampling rate of max. 25 GSa/s. The oscilloscope will not automatically enter this mode, however, it is possible to select automatic switching to Random sampling >20 ns/div..The mode can be disabled by pushing the soft key.
- **PEAK DETECT:**
At very slow sweep speeds fast signal details will not be visible. By selecting this mode peaks will be detected. This function can be switched on or off in the menu, it is also possible to select automatic switching in.
- **HI RES:**
This modes extend the vertical resolution to 10 Bit max. This is done by an boxcar averaging, which average adjacent sample points of an aquisition. The advantage is, that there is a higher vertical resolution, the downside is, that the bandwidth is reduced. This function can be switched on or off in the menu, it is also possible to select automatic switching in.

All the preceding functions are normally off. The lowest item in the soft menu allows you to select the preferred signal capturing repetition rate, there are 3 options:

- **MAX. REP RATE:**
In this mode an optimum combination of sampling rate and memory length used will be selected automatically such that the signal capturing rate will be maximized.
- **MAX. SAMPL. RATE:**
In this mode the maximum possible sampling rate will be used.
- **AUTOMATIC:**
This mode is the standard mode: the instrument always selects the optimum combination of capturing and sampling rates (full memory length used).

The last menu INTERPOLATION allow the selection of Sinx/x, linear or Sample-Hold as interpolation type for displaying the aquired data points. Standard setting is Sinx/x. At the linear interpolation there is a straight line used to connect the points. Using sample-hold type of interpolation allow the exact examination of the position of the the aquired data points within the signal.

5.4 ZOOM function

The HMO oscilloscope features a memory depth of 1 MB per channel, this allows you to record long complex signals which can be analyzed in detail with the ZOOM function. Push the ZOOM key to activate this function. The screen will be partitioned into two graticule areas: the top one displays the whole time base window; the lower one displays the zoomed portion of it. The zoomed portion will be indicated in the upper display by two blue cursors. With multi channel displays all channels will be zoomed by the same factor and on the same portion.

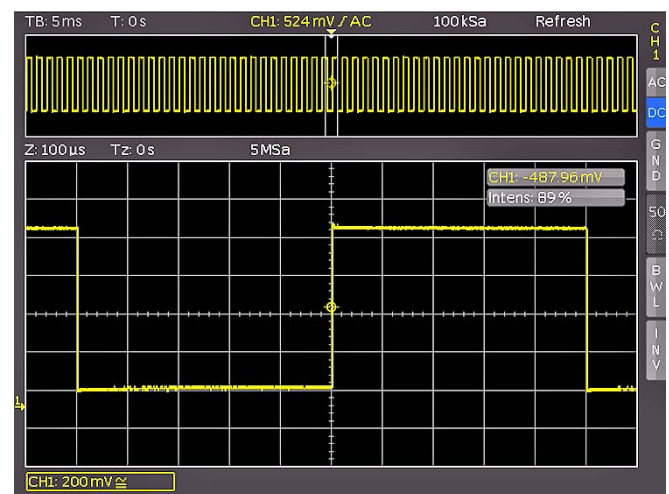

Fig. 5.2: Zoom function

In Fig. 5.2 a signal was recorded for 12 ms, the zoom window is shown with a time scale of 100µs/div. The time base speed display in the left upper corner is shown with a grey background, the zoom time base display is shown in white. This means that the large knob in the horizontal menu is now available for changing the zoom factor. This knob also features a push contact; if the knob is pushed, the time base display will change to white, and the zoom time base display to grey: now the knob is available for changing the time base setting. This allows you to change time base settings without leaving the zoom mode. By pressing the knob again, the cursors limiting the zoom area will be shown pronounced in white, now the knob will also allow to change the zoom area. The position of the zoomed area can now be shifted with the small knob in the horizontal area of the front panel over the whole signal. If pushing the large knob as described above would influence the time base setting and not the zoom factor, the small knob regains the function of shifting the trigger position so the relationship of pre to post trigger record can be changed.

5.5 Marker function

In order to access the marker function, press the key MENU in the HORIZONTAL area of the front panel, then select the soft menu TIME MARKER. If this mode is activated, a time marker may be set by pressing the SET/CLR key at the 6th unit of time (if the menu is deactivated this will be the center of the grati-

cule). The markers are identified by a grey-blue vertical line. Now the curve can be shifted with the position control knob, the marker set will go along. If another interesting point is found, another marker may be set after the point has been shifted to the graticule center. By this method up to 8 interesting points of a curve may be marked. By pressing one of the arrow buttons the next marker left or right of the center will be shifted to the center. In order to erase a marker, shift it to the center and press the key SET/CLR anew. After pressing the key MENU in the HORIZONTAL area of the front panel all markers can be erased by pressing the respective soft menu key.

By centering the markers with the arrow buttons a comparison of signal portions marked in the ZOOM mode is possible, simply and very fast.

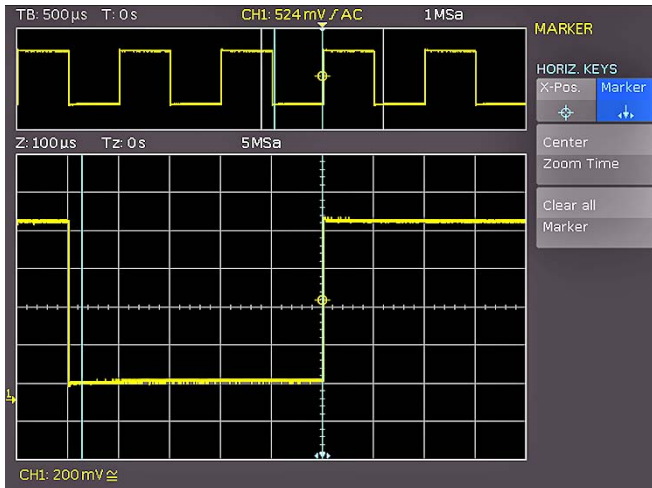

Fig. 5.3: Marker in zoom mode

6 Trigger System

The trigger system of the HMO is easy to handle by just observing the HAMEG concept of instrument operation.

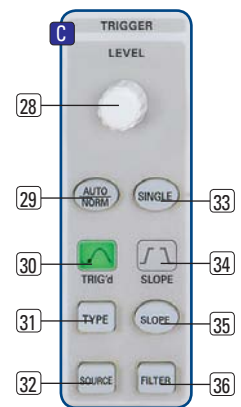

Fig. 6.1: Front panel control area of the trigger system

There are 4 keys destined for frequently used functions:

- **TYPE:** selects the type of trigger: SLOPE, PULSE, LOGIC, VIDEO, the B-TRIGGER or the (optional) Serial BUS
- **SLOPE:** selects the slope polarity. (rising, falling or both)
- **SOURCE:** opens the menu for the selection of the trigger source.
- **FILTER:** opens the menu for the selected trigger type in order to select the exact trigger conditions.

Additional keys are provided for the selection of the trigger modes: [AUTO. NORMAL, SINGLE].

6.1 Trigger modes Auto, Normal, Single

The basic trigger modes are directly selectable with the key AUTO NORM. In AUTO mode the key will not be lit. If the key is pushed it will light up red indicating NORMAL mode. The oscilloscope always presents a signal in AUTO mode and a signal will automatically yield a stable display if it fulfills the trigger conditions.

In NORMAL mode the signal will be displayed if it fulfills the trigger conditions, if it fails to do so the last stable triggered display will remain on the screen.

If it is desired to record a signal which fulfills the trigger conditions only once, the key SINGLE must be pushed, it will

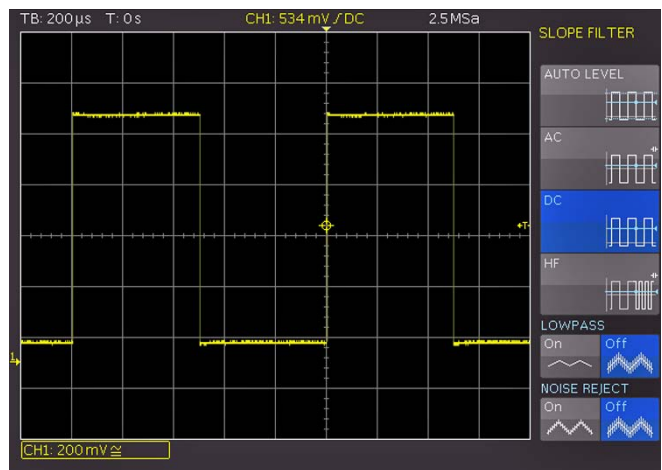

Fig. 6.2: Coupling modes with slope trigger

light up white. This indicates that the single trigger mode is active, the RUN/STOP key will blink. The next return of the signal will cause a single capture, the oscilloscope then goes into the STOP mode, indicated by the RUN/STOP key lighting up in red.

6.2 Trigger sources

Trigger sources are the 2 or 4 analog channels and the external trigger input. If the optional logic probe H03508 with 8 or 16 logic channels is connected, also those up to 16 digital channels can serve as trigger sources.

6.3 Slope trigger

The simplest and most used trigger type is slope trigger, this one is also selected in the AUTOSETUP function. Pushing the AUTOSETUP key will hence change any previously selected trigger type to slope trigger. For the selection of the trigger type push the key TYPE in the trigger control section of the front panel. A menu will open and offer the options. If the type SLOPE was not selected (blue background) pushing the respective soft key will change to slope. The SLOPE key is also used to step through the options rising, falling, or both slopes. In the center of the status line top center above the graticule the type selected will be shown. If the key FILTER is pushed, the respective menu will open and offer the available options.

Here the trigger signal coupling can be selected:

DC: The trigger signal is used with its dc content.

AC: The trigger signal is routed via a 5 Hz high pass filter.

HF: The trigger signal is routed via a 15 kHz high pass filter. The trigger level is no longer adjustable. This mode should only be used with very high frequency signals.

LOW PASS: The trigger signal is routed via a 5 kHz low pass filter.

NOISE RED.: The trigger signal is routed via a 100 MHz low pass filter removing higher frequency interference. This is automatically set for all vertical gain settings <5mV/div.

The coupling modes low pass and noise reduction can not be simultaneously selected, but they can be used with DC or AC coupling.

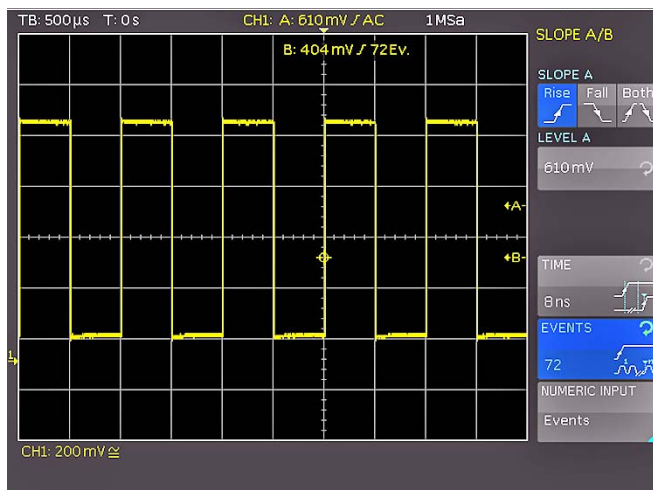

Fig. 6.3: The type B-Trigger

The slope trigger can be coupled with a so called „B Trigger“. This option is available after pushing TYPE. This function allows you to adjust the trigger such that first condition „A“ must be met and then another condition „B“ before the trigger will respond (refer to Fig. 6.3).

E.g. it is possible to define a source (channel) and a level of 120mV on the rising slope of that signal and for the second condition a level of 80mV on the falling slope. Additionally, it is possible to define whether the B event should occur a time (min. 8ns) or a number (min. 1) of times after the A event. The level or time or the number of events can be entered numerically with the universal knob or in a submenu. In order to do this first select the setting, then push the soft key next to **NUMERIC INPUT**. In the window which will open, you can enter numbers and units with the combination of universal knob, the CURSOR SELECT key and the visible softmenu functions.

6.4 Pulse trigger

The pulse trigger allows you to trigger on finite pulse widths of positive or negative pulses, or ranges thereof. Select the pulse trigger by pushing the key TYPE and the respective soft key next to PULSE. Further settings are available in the soft menu after pushing FILTER.

There are 6 options:

- $t_i \neq t$: The pulse width t_i is unequal to the reference width t .
- $t_i = t$: The pulse width t_i is equal to the reference width t .
- $t_i < t$: The pulse width t_i is smaller than the reference width t .
- $t_i > t$: The pulse width t_i is greater than the reference width t .
- $t_1 < t_i < t_2$: The pulse width t_i , is smaller than the reference width t_2 and greater than the reference width t_1 .
- $\text{not}(t_1 < t_i < t_2)$: The pulse width t_i , is greater than the reference width t_2 and smaller than the reference width t_1 .

First select the desired option and then adjust the desired reference time. If you choose „ $t_i \neq t$ “ od „ $t_i = t$ “, you can select the reference time after pushing the soft key next to TIME by turning the universal knob. If you choose the soft menu item DEVIATION the universal knob is used to define a tolerance interval. If you chose $t_i < t$ or $t_i > t$, you can only define one limit. Both options with two references (t_1 and t_2) can be set due to pressing the respective soft key and turning the universal knob. All these settings can be combined with positive or negative pulses by selecting the respective soft menu keys. With positive pulses the width is defined from the rising to the falling slopes, with negative pulses from the falling to the rising slopes. Triggering will then be on the second slope of the pulse.

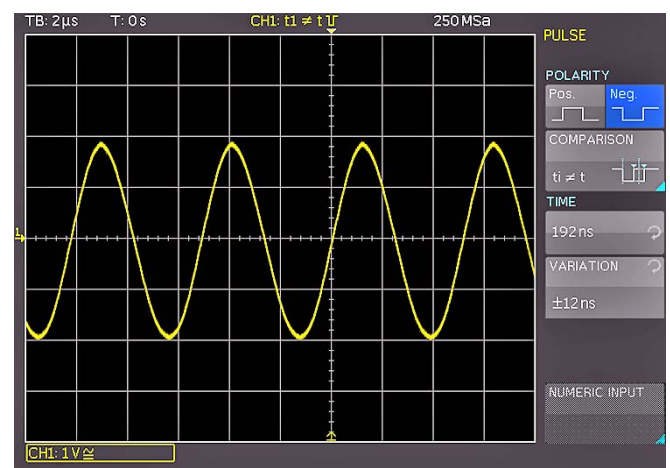

Fig. 6.4: Pulse trigger menu

6.5 Video trigger

The video trigger allows you to trigger on PAL, NTSC, SECAM standard video signals or on HDTV Signals. Select this mode by pushing the key TYPE in the trigger control section of the front panel. The source is again selected after pushing the key SOURCE. In the menu which opens after pushing the key FILTER all further settings may be performed.

First select the standard pushing the respective soft key STANDARD. Using the universal knob or pushing the soft key again the standard is chosen. As usual the selection will be indicated by a blue background in the menu. The second setting will apply to the polarity of the sync pulses. Next either the mode LINE or FRAME can be selected. If LINE was selected, the precise number of a desired line can be selected with the universal knob from the 8th to the 623rd; this will be activated by pushing the soft key next to the line number. The two other menu items allow fast selections: LINE MIN sets the trigger line to the minimum value, ALL LINES will cause triggering on any line. If FRAME was chosen, the lower menu items will allow to trigger on ALL, only the ODD or only the EVEN half frames.

The following modes are available:

PAL	
NTSC	
SECAM	
PAL-M	
SDTV 576i	Interlaced
HDTV 720p	Progressive
HDTV 1080p	Progressive
HDTV 1080i	Interlaced

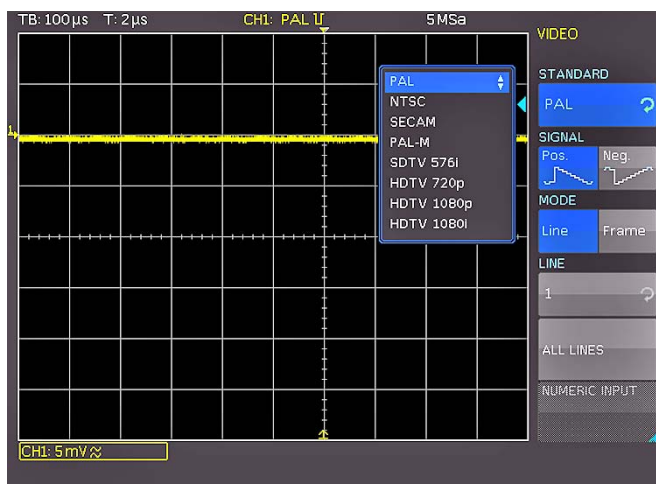

Fig. 6.5: Video trigger menu

7 Display of signals

The following chapter describes the selection and display of signals from various sources and the available display modes.

7.1 Display settings

The HMO features a high quality TFT – VGA (640 x 480 pixel resolution) display with LED backlighting. The basic settings will become accessible in the menus which will open after pushing the key DISPLAY in the GENERAL section of the front panel. If the menu item SCROLL MODE is activated, a rolling bar will appear to the right of the graticule; a virtual display window of 20 divisions will become available which can be shifted up and down with the universal knob. A detailed description will follow in the next chapter.

There are 3 more menu items on the first page:

DOTS ONLY :

The respective soft menu key will toggle between ON and OFF. If ON is activated, only the captured samples will be shown as dots. If OFF is activated, interpolated points will be shown as well.

INVERSE LIGHT :

The respective soft menu key will toggle between ON and OFF. If ON is activated, those display points will be shown darker which appear most frequently. If OFF is activated, they will be shown brighter.

FALSE COLOURS :

The respective soft menu key will toggle between ON and OFF. If ON is activated, the color of the display points are shown from blue over magenta, red and yellow up to white with growing number of appearing points. If OFF is activated, the most frequently appearing ones will be shown brighter and the rarer ones darker. If you enter page 2 of the menu, you will have three additional choices.

GRATICULE :

If this menu item is selected, the submenu which opens up will allow you to choose:

- **LINES:**
The graticule is divided into horizontal and vertical divisions.
- **CENTER CROSS:**
There will be just one center vertical line and one center horizontal line; the divisions will be marked by dots.
- **OFF:** The screen will be empty.

INFO WINDOW :

If this menu item is selected, a submenu will open up which allows change of the transparency of the info windows (e.g. for showing changes of the offset) from 0 to 100 %. This is done with the universal knob. The info windows of the POSITION and the CURVE INTENSITIES may be switched on or off if their respective menus are chosen.

AUX. CURSORS :

Pushing the respective soft menu key will open a submenu which allows you to switch the auxiliary cursors for the trigger level, the trigger time and the channel cursors on or off.

7.2 Use of the virtual screen area

The HMO graticule has 8 vertical divisions but there is a virtual range of 20 divisions. These may be used by the 8 digital

channels D0 to D7, the math functions and the references. The analog channels can only use up to ± 5 divisions from the center.

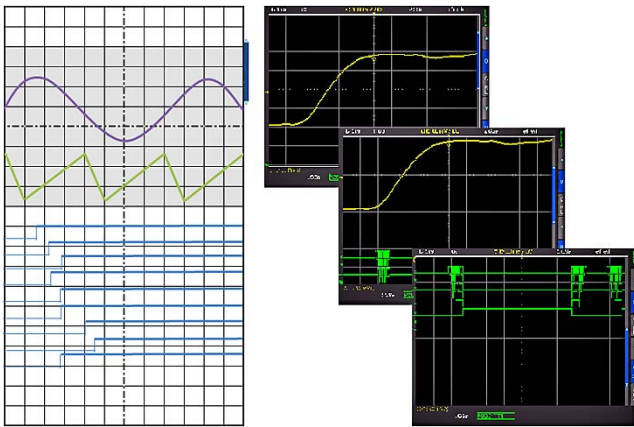

Fig. 7.1: Drawing of the virtual screen area and an example

The picture above explains the function of the virtual screen. The visible 8 divisions are shown in grey; this is the area available for analog signals. To the right of the graticule there is a small bar which indicates the position of the visible 8 divisions within the possible 20 divisions. By pushing the key SCROLL BAR the bar will be activated indicated by its color changing to blue; now turning the universal knob will shift the visible 8 divisions (grey area) within the available 20 divisions. This allows a simple and clear display of many individual signal portions.

7.3 Signal intensity and persistence functions

In the standard mode, the key INTENS/PERSIST will light up white: the intensity of the signal display can be changed with the universal knob from 0 to 100 %. The persistence mode may be selected for the display of varying signals: this is a storage mode such that several curves may be written to remain on the screen. Also the so called „Variable Persistence“ may be selected: in this mode the persistence can be changed from 50 ms to infinity; this will cause the most recent portion of the signal to appear bright while the preceding portions will fade in proportion to the time elapsed. This mode can be selected in the soft menu which will open upon pushing the key INTENS/PERSIST; the signal intensity can be changed also in this menu.

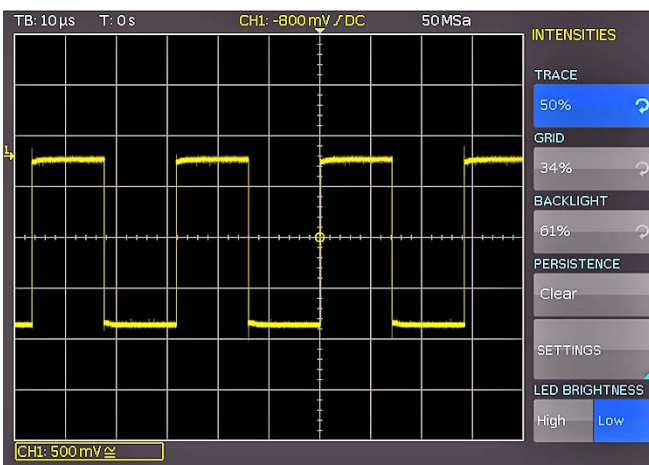

Fig. 7.2: Menu for setting the signal display intensities

Two more menu items are available: GRID and BACKLIGHT by pushing the respective soft menu keys; the intensities can be changed with the universal knob. The soft menu key next to

the lowest menu item toggles between HIGH and LOW of the LED's of all backlit keys and all other LED displays on the front panel.

After selecting the menu items PERSISTENCE and ADJUST the persistence function can be defined: there are 3 choices for the duration of the persistence: OFF, AUTOMATIC and MANUAL. In MANUAL operation, the duration can be changed with the universal knob from 50 ms to infinity. If a finite time was selected, the signal periods will be written on top of each other such that the brightness will diminish from recent to oldest. If e.g. 300ms is selected, the signal curves will become darker in 50ms steps and erased after 300ms. In this soft menu the function BACKGROUND may be activated in addition: then all signal curves ever displayed will be shown in the darkest colour.

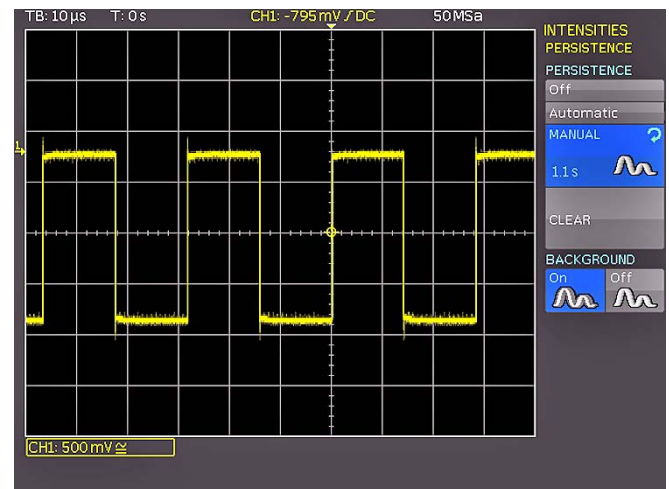

Fig. 7.3: Persistence function

This kind of display is for example very useful for the analysis of extreme values of different signals.

7.4 XY display

The HMO has a key for directly switching to the XY function. In this mode, two signals will be displayed, one in Y, one in X direction. The usual time base will be replaced by the amplitudes of the second signal. With harmonically related signals the resulting curves are called Lissajous patterns; from such displays the frequency and phase relationships of the signals may be derived. The XY function will be activated by pushing the XY key in the VERTICAL section of the front panel; the key will

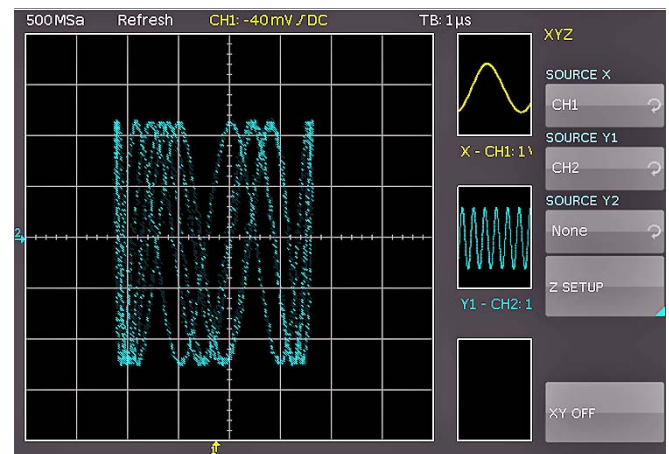

Fig. 7.4: Settings in the X-Y menu

light up, and the screen will be partitioned in a large and some small display fields: the large display will show the XY presentation, the small fields will show the sources of the X, the Y1, Y2 and Z signals; those signals will be displayed vs. time as usual. It is possible to define two signals as the Y signal and display this vs. the X signal in order to perform a comparison. In order to define which signal should be X, Y1, Y2 or Z, it is necessary to call the menu by a pushing the XY key a second time. In this menu the desired settings may be performed.

In order to select the Z input setting please push the soft menu key next to the menu item **Z SETTINGS**, this will open the next menu level. The Z input allows control of the intensity of the X-Y curve. This intensity may be either set to a desired level or it may be dynamically modulated by the amplitudes at the Z input.

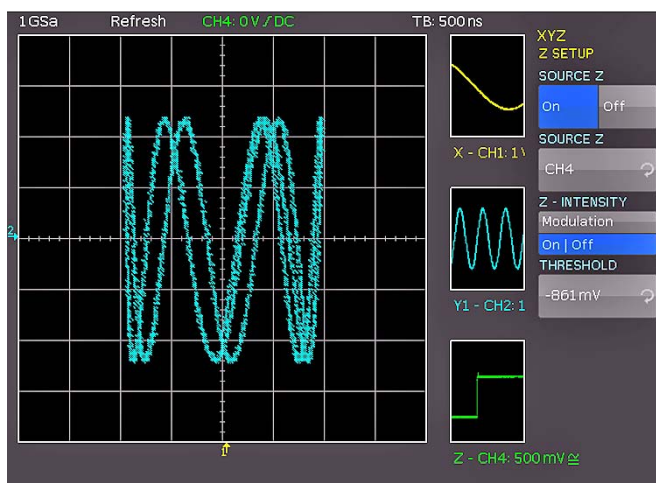

Fig. 7.5: Settings for the Z input

In this menu you can first activate the Z input (top menu item **ON** or **OFF**, the activated mode will be backlit in blue). In the next menu item all channels are offered as inputs, the selection is performed with the universal knob and activated by pushing the respective menu key next to **SOURCE Z**. The following menu item allows you to define the intensity setting. The menu key will toggle between **Modulation** and **On/Off**. If **Modulation** is selected, the XY signal will be intensity modulated by the amplitude at the Z input. The intensity will be proportional to the Z input signal amplitude. If **On/Off** is selected, all XY points below a certain level at the Z input will be shown dark, and all above this level will be bright. The level can be set with the universal knob after pushing the respective soft menu key.

Pushing the XY key in the VERTICAL section of the front panel again will terminate the XY function if it was active. If no or another menu should be active, it will be necessary to push the XY key twice for terminating the function.

8 Measurements

There are two different kinds of measurements on signals: cursor measurements and automatic measurements. All results are stored in a buffer memory which is larger than the display memory. The QuickView mode delivers all available parameters of a signal curve. The integrated hardware counter shows the count results on the selected channel.

8.1 Cursor measurements

The most frequently used measurement method with an oscilloscope is the cursor measurement. The HAMEG concept is oriented towards the expected results and thus provides not only one or two but in some modes, three cursors. Cursor measurements are controlled by the keys: **CURSOR MEASURE** and the universal knob. The kind of measurement can be defined in the menu which will open upon pushing the key **CURSOR MEASURE**.

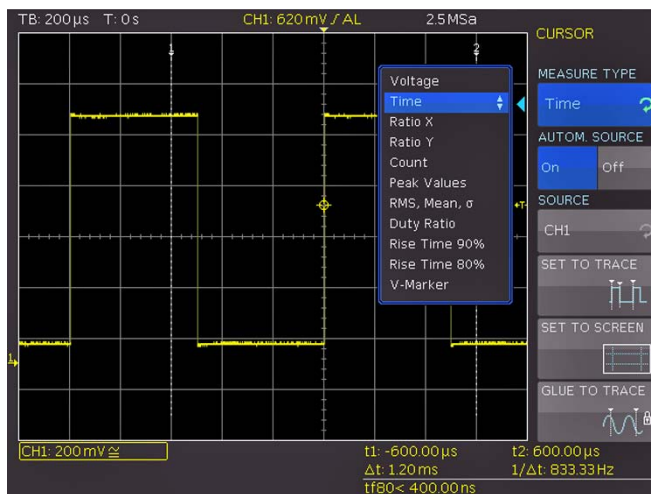

Fig. 8.1: Cursor measurements selection menu

As shown above, the selection of the kind of measurement can be done by pushing the respective soft menu key and selecting the kind of cursor measurement with the universal knob. The results will be displayed below the graticule. In order to move a cursor, select the desired cursor by pushing the universal knob and position the cursor with the universal knob. The kinds of measurements are:

VOLTAGE

This mode provides 2 cursors in order to measure 3 different voltages. The values V_1 and V_2 represent the voltages differences between the zero base line and the actual positions of the two cursors on the selected signal curve. ΔV represents the voltage difference between the cursors.

TIME

This mode provides 2 cursors in order to measure 3 different times and an equivalent frequency. The values t_1 and t_2 represent the times between the trigger and the position of the cursors. Δt represents the time between the cursors.

RATIO X

This mode provides 3 cursors in order to measure ratios in X direction (e.g. a duty cycle) between the first and the second and between the first and the third cursors. The values will be presented in 4 different formats: floating point, percent, degrees, radians.

RATIO Y

This mode provides 3 cursors in order to measure ratios in Y direction (e.g. an overshoot) between the first and the second and between the first and the third cursors. The results will be presented in 2 formats: floating point, percent.

COUNT

This mode provides 3 cursors in order to count signal crossings of a level which can be set with the third cursor for a time span as defined by the distance between the first and the second cursors. The result will be presented in 4 different versions: number of rising and falling level crossings, number of positive and negative pulses.

PEAK LEVELS

This mode provides 2 cursors in order to measure the minimum and maximum values of a signal within the time span as defined by the two cursors. The values V_p- and V_p+ represent the minimum and maximum values of the voltage. The peak-to-peak value (V_{pp}) is equal to the difference between the minimum and maximum values.

RMS, MEAN, Standard deviation, σ

This mode provides 2 cursors in order to calculate the rms, the mean and the standard deviation σ values of a signal between the two cursors.

Duty cycle

This mode provides three cursors in order to calculate the duty cycle of the signal between the two horizontal cursors. The third vertical cursor will set the level at which the duty cycle is determined.

Rise-time 90%

This mode provides 2 cursors in order to measure the rise and fall times between the two cursors. The rise and fall times are measured between 10% to 90% of the signal amplitude.

Rise-time 80%

This mode provides 2 cursors in order to measure the rise and fall times between the two cursors. The rise and fall times are measured between 20% to 80% of the signal amplitude.

V MARKER

This mode provides 2 cursors in order to measure two different voltages and a time span. The values V_1 and V_2 represent the voltages between the zero base line and the respective cursor. ΔV represents the voltage difference between the two cursors. Δt represents the time difference between them.

The menu item **AUTO SOURCE** may be turned on or off with the associated soft menu keys **ON** and **OFF**; the active state is marked by its blue background. If **ON** was chosen, the cursor measurements will be executed on the active channel; this allows you to quickly execute similar measurements on different signals. If **OFF** was selected, measurements will always be performed on the channel selected in the menu **SOURCE**.

By pushing the soft key next to the menu **SET**, the selected cursors will be automatically placed on optimum positions along the signal curve; this allows very fast and usually optimum placement of the cursors. As mentioned earlier, the cursors may also be placed manually with the universal knob after pushing this universal knob selecting them. In case the automatic placement does not function with very complex signals, the cursors can be brought to a predefined starting position by pushing the key next to the menu **CENTER**. The last menu item allows you to switch the cursors off by pushing the soft key next to it.

At the cursor menu there is a item **GLUE TO**. This mode can be turned on or off. If activated, the cursors will „glue to“ the signal, i.e. they will automatically follow all changes of the position and scaling controls and also deliver new measurement results. If this mode is deactivated, the cursors will remain in their positions irrespective of any repositioning or rescaling of the signals.

Pushing again the button **CURSOR MEASURE** switch off all cursors.

8.2 Auto measurements

The HMO series oscilloscopes offer cursor measurements and additionally automatic measurements. By pushing the key **AUTO MEASURE** in the ANALYZE section of the front panel the menu will open.

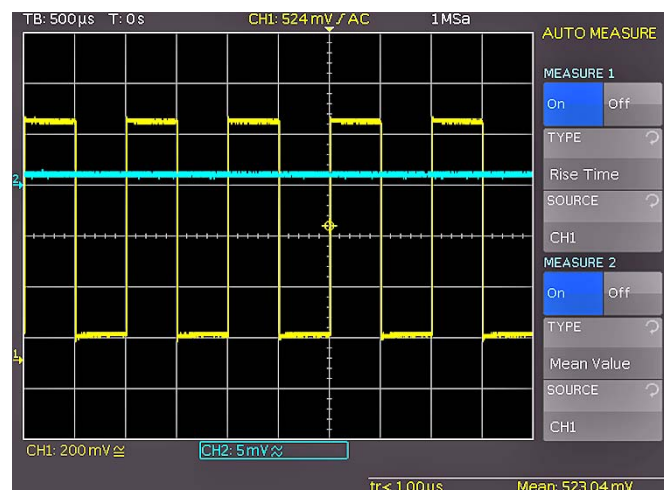

Fig. 8.2: Menu for the automatic measurements settings

This menu offers the selection of two auto measurement functions: **MEASURE 1** and **MEASURE 2** can be switched **ON** or **OFF** with the respective soft menu keys. The associated soft menus will open selection windows upon pushing the respective menu key. Each window will present all available kinds of measurement which can be selected with the universal knob. The source for the measurements can be selected with the universal knob after pushing the respective soft menu key. The listing of available sources will only show the displayed channels. The results will be displayed in the right bottom corner of the screen.

The following kinds of measurement are available:

MEAN

In this mode the mean value of the signal will be measured. With periodic signals only the first period shown on the left of the graticule will be measured.

RMS

This mode measures and calculates the rms value of the signal but only for those portions of the signals which are displayed. If the signal is periodic, the first period displayed will be used. The „true rms“ value will be calculated.

AMPLITUDE

This mode measures the amplitude of a square wave. To this the potential difference between high and low level (V_{base} and V_{top}) is calculated. The measurement effects only on the selected channel and needs at least one complete period of a triggered signal.

TOP LEVEL

This mode measures the mean voltage level of the high level of a square wave. Therefore the mean of the ramp is calculated (without the overshoot). The measurement effects only one the selected channel and needs at least one complete period of a triggered signal.

BASE LEVEL

This mode measures the mean voltage level of the low level of a square wave. Therefore the mean of the ramp is calculated (without the overshoot). The measurement effects only one the selected channel and needs at least one complete period of a triggered signal.

PEAK-TO-PEAK

In this mode the voltage difference between the minimum and maximum values of the displayed signal will be measured.

PEAK +

In this mode the positive peak value of the displayed signal will be measured.

PEAK -

In this mode the negative peak value of the displayed signal will be measured.

PERIOD

In this mode the duration of the signal period will be measured. The period is defined as the time between two identical portions of a recurring signal.

FREQUENCY

In this mode the signal frequency will be measured as the reciprocal of the period. Only the first period will be used. The measurement pertains only to the selected channel.

COUNT +

In this mode the number of positive pulses displayed will be counted. A positive pulse is defined as consisting of a rising and a falling slope. The switching level will be calculated by measuring the mean value of the signal. A crossing of this level only in one direction will not be counted.

COUNT -

In this mode the number of negative pulses displayed will be counted. A negative pulse is defined as consisting of a falling and a rising slope. As before, the mean value of the signal will be measured and used as the trigger level. A crossing of this level only in one direction will not be counted.

COUNT +/-

In this mode positive slopes of the signal within the displayed area will be counted. As before, the mean value of the signal will be measured and used as the trigger level.

COUNT -/

In this mode negative slopes of the signal within the displayed area will be counted. As before, the mean value of the signal will be measured and used as the trigger level.

PULSE WIDTH +

This mode measures the width of a positive pulse. A positive pulse consists of a rising edge follow by a falling edge. The measurement effects only one the selected channel and needs at least one complete pulse of a triggered signal.

PULSE WIDTH -

This mode measures the width of a negative pulse. A negative pulse consists of a falling edge follow by a rising edge. The

measurement effects only one the selected channel and needs at least one complete pulse of a triggered signal.

POSITIVE DUTY CYCLE

This mode measures the positive duty cycle. To this the share of the positive alternation within a period is measured and is placed in relation to the signal period. The measurement effects only one the selected channel and needs at least one complete period of a triggered signal.

NEGATIVE DUTY CYCLE

This mode measures the negative duty cycle. To this the share of the negative alternation within a period is measured and is placed in relation to the signal period. The measurement effects only one the selected channel and needs at least one complete period of a triggered signal.

RISE-TIME 90%

In this mode the rise-time of the first displayed positive slope will be measured. The rise-time is defined as the time span between 10 to 90 % of the full amplitude.

RISE-TIME 80%

In this mode the rise-time of the first displayed positive slope will be measured. The rise-time is defined as the time span between 20 to 80 % of the full amplitude.

FALL TIME 90%

In this mode the fall time of the first displayed negative slope will be measured. The fall time is defined as the time span between 90 to 10 % of the full amplitude.

FALL TIME 80%

In this mode the fall time of the first displayed negative slope will be measured. The fall time is defined as the time span between 80 to 20 % of the full amplitude.

σ -STD. DEVIATION

In this mode the standard deviation of the signal amplitude will be measured.

TRIGGER FREQ

In this mode the frequency of the trigger signal as the reciprocal of its period will be measured. The source for this measurement is the actual selected trigger source. The measurement is performed with a 6 digit hardware counter.

TRIGGER PER.

In this mode the duration of a trigger period is measured with a hardware counter.

DELAY

In this mode the delay between two edges of two analog channels are measured. The settings of the measure- and reference source as well as the edges are possible in a submenu.

PHASE

In this mode the phase between two edges of two analog channels are measured and displayed in degree.

9 Analysis

The HMO series oscilloscopes feature a variety of analysis functions for the stored data sets which will be displayed on the screen. For simple mathematical functions „Quick mathematics” is provided. The formula editor allows you to create more complex functions and the linking of functions. The frequency analysis is accessible by just pushing a key.

9.1 Quick mathematics

Pushing the MATH key on the front panel will call a short menu, the key will light up red.

Next to the lowest soft menu key QM/MA the mode activated will be indicated in red. QM stands for Quick Mathematics, MA for extended mathematics. Pressing this soft menu key will alternate between those two mathematics variants.

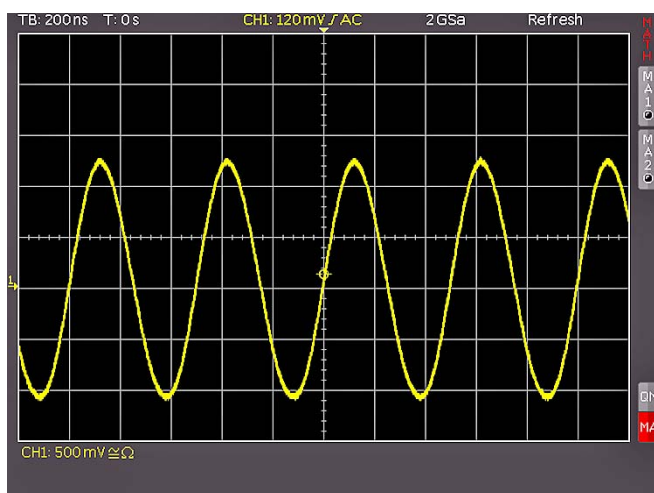

Fig. 9.1: Mathematics short menu

The predefined mathematical functions can be switched in by pushing the respective soft menu keys. If a function is active, the black dots will change to red ones. If two were activated, the remaining ones will be shown in grey. If you desire to perform an addition, subtraction, multiplication or division between two channels, first make sure that QM is shown with a red background. The associated short menu allows to select the desired function.

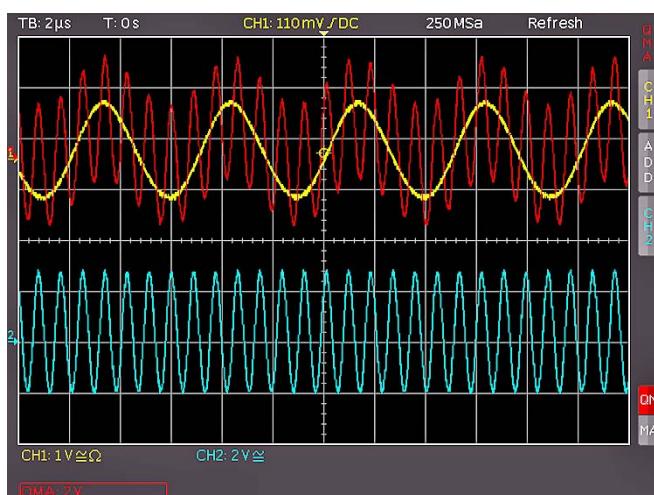

Fig. 9.2: Quick mathematics menu

The upper 3 menu keys allow you to select the sources as well as the operation. All active channels are available as sources. The available operations are addition and subtraction.

9.2 Formula editor

The HMO series offers 5 sets of mathematical formulas. Each of these sets contains 5 equations which can be modified with a formula editor in order to construct more complex mathematical formulas. They are designated MA1 to MA5. The available operations are:

- Addition
- Subtraction
- Multiplication
- Division
- Maximum
- Minimum
- Squaring
- Square root
- Absolute value
- Negative value
- Reciprocal value
- Inverted value
- Common logarithm
- Natural logarithm
- Differentiation
- Integration
- IIR low pass filter
- IIR high pass filter
- Positive value

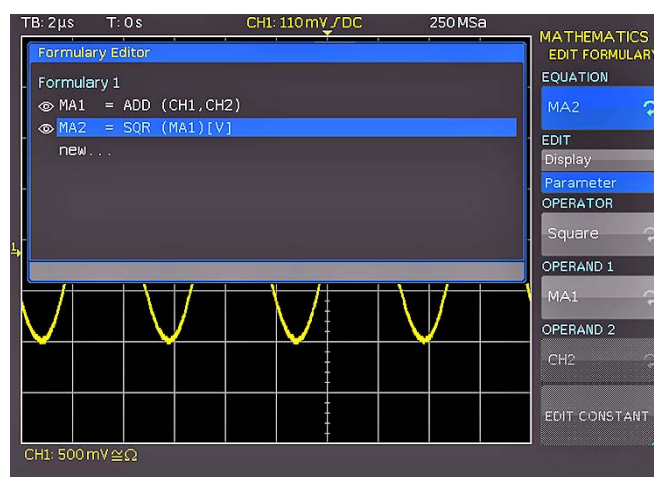

Fig. 9.3: Formula editor for a set of formulas

The sources for the equation in MA1 are the input channels CH1, CH2, CH3, CH4 and a constant which can be defined. For the formula MA2, MA1 is an additional source. For MA3 additional sources are MA1 and MA2. For MA4 additional sources are MA1, MA2, and MA3. For MA5 additional sources are MA1 to MA4. It is possible to construct a total of 5 different sets from these 5 equations which can be subsequently stored and recalled.

Press the MATH key to access the formula editor, then select „MA” with the lowest soft menu key (i.e. MA is shown with a red background), next press the MENU key in the vertical section of the front panel. A menu will open in which the menu item FORMULA SET will be shown with a blue background. Now the desired formula set can be selected with the knob (there are 5 different ones). In this soft menu you may attribute names to the formula sets (with a maximum of 8 characters), you may load a formula set (from the internal memory or a USB memory stick) you may store a formula set (into the internal memory or onto a USB memory stick) and also modify a formula set. Inputting of formulas is done by pressing the soft menu key MODIFY. A menu will open in which the top entry EQUATION is selected. The universal knob allows to select up to 5 equations (standard names MA1 to MA5); if less than 5 are defined, the last formula will lead to the field NEW. With the soft menu key next to ADD, the formula set may be extended by another formula. If a formula was selected or newly added, the soft menu key next to MODIFY is used to activate PARAMETER

(this is activated if the word is shown with a blue background) . After selecting the operators and the operands, press the soft menu key next to MODIFY to activate DISPLAY (if activated the word will be shown with a blue background). In this menu you have the opportunity to display the equations, to add physical units (e.g. A) and to attribute names.

In Fig. 9.4, in formula MA1, a current of 100 μ A is added to the channel 1. In the menu for entering constants it is possible to choose from the following list of constants, executed by pushing the key CONSTANT and turning the universal knob:

- Pi
- 2x Pi
- 0,5 x Pi
- User 1 . . . 10
(there are up to 10 user defined constants possible)

If e.g. **User 1** is selected, it is possible to set the value with the universal knob after pushing the menu key next to **VALUE**. Following the same procedure the decimal point and a possible SI-prefix can be set. The following SI-prefixes are available:

- | | |
|------------------------------------|--------------------------------|
| - m (Milli, 10 ⁻³) | - K (Kilo, 10 ³) |
| - μ (Mikro, 10 ⁻⁶) | - M (Mega, 10 ⁶) |
| - n (Nano, 10 ⁻⁹) | - G (Giga, 10 ⁹) |
| - p (Piko, 10 ⁻¹²) | - T (Tera, 10 ¹²) |
| - f (Femto, 10 ⁻¹⁵) | - P (Peta, 10 ¹⁵) |
| - a (Atto, 10 ⁻¹⁸) | - E (Exa, 10 ¹⁸) |
| - z (Zepto, 10 ⁻²¹) | - Z (Zetta, 10 ²¹) |
| - y (Yokto, 10 ⁻²⁴) | - Y (Yotta, 10 ²⁴) |

The menu item **UNIT** offers the following list of units, selectable with the universal knob:

- | | |
|----------------------------------|-------------------------------------|
| - V (Volts) | - π (Pi) |
| - A (Amperes) | - Pa (Pascal) |
| - Ω (Ohms) | - m (Meter) |
| - V/A (Volts per Ampere) | - g (Acceleration) |
| - W (Watts, active power) | - $^{\circ}$ C (Degrees Celsius) |
| - VA (Voltamps, apparent power) | - K (Kelvin) |
| - VAR (Voltamps, reactive power) | - $^{\circ}$ F (Degrees Fahrenheit) |
| - dB (decibels) | - N (Newton) |
| - dBm (dB referred to 1 mW) | - J (Joule) |
| - dBV (dB referred to 1 V) | - C (Coulomb) |
| - s (Second) | - Wb (Weber) |
| - Hz (Hertz) | - T (Tesla) |
| - F (Farad) | - (dez) (dezimal) |
| - H (Henry) | - (bin) (binary) |
| - % (Percent) | - (hex) (hexadezimal) |
| - $^{\circ}$ (Degree) | - (oct) (octal) |
| | - DIV (Division, graticule) |
| | - px (pixel) |
| | - Bit (Bit) |
| | - Bd (Baud) |
| | - Sa (Sample) |

After entering the value, the prefix, the unit (or any combination) push the soft menu key next to **STORE**: now this will be stored at the address **USER 1**, then the system will automatically return to the menu for equations. It is possible to store up to 10 user defined constants.

In this menu it is further possible to add a name to each of the 5 equations: in order to do this first select the desired equation, then push the lowest menu key **NAME**, this will open a window. Now the intended name (up to 8 characters) can be defined by turning and pushing the universal knob; the name will be accepted after pushing the soft menu key next to **ACCEPT** and displayed in place of MA1 ... MA5. This may be done separately for all equations. After entering all equations, constants and names it is possible to also add a name for this set of formulas

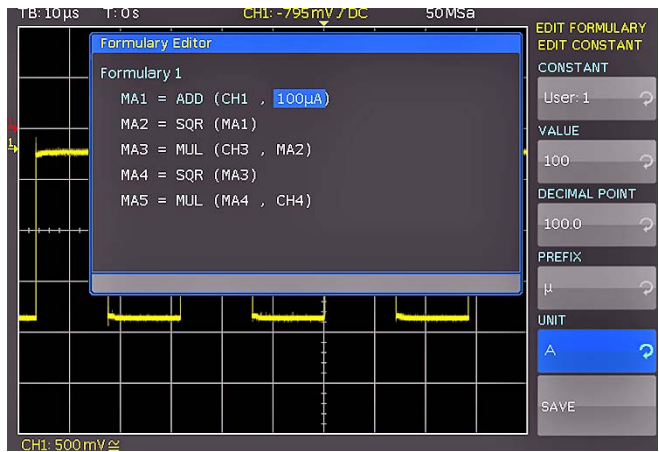

Fig. 9.4: Entering constants and units

by pushing the key next to **NAME** in the set of formulas menu and following the above procedure again. The completed set of formulas may be stored in the instrument or on a USB stick. In order to do this push the key next to **STORE**, a menu will open which allows you to select the storage medium by pushing the top menu key (internal, USB front panel, USB rear panel). The menu item below offers to add a name for the set of formulas. A commentary can be added by pushing the key next to **COMMENTARY**. By pushing the key next to **STORE** the set of formulas together with the name chosen and a commentary will be stored in the selected location.

Stored sets of formulas may be recalled any time. In order to do this activate the mathematics by pushing the key MATH and then the key MENU and the V/DIV knob. A menu item **LOAD** will appear in this menu. By choosing this, the data control will appear, showing the internal memory location, and, if an USB stick is plugged in, also that location. Select the desired location and push the key **LOAD**.

9.3 Frequency analysis (FFT)

The frequency analysis function will be called by pushing the key FFT in the ANALYZE section of the front panel, the key will light up white, the screen will be divided into two graticules. In the upper smaller area, the signal will be displayed vs. time, in the lower, larger area the result of the FFT analysis will be shown. The lower FFT display window will be framed in white. This means that the large knob in the time base area is now dedicated to selecting the span, and that the small knob X POSITION to setting the CENTER position. The FFT will be calculated up to a maximum of 65536 acquisition samples.

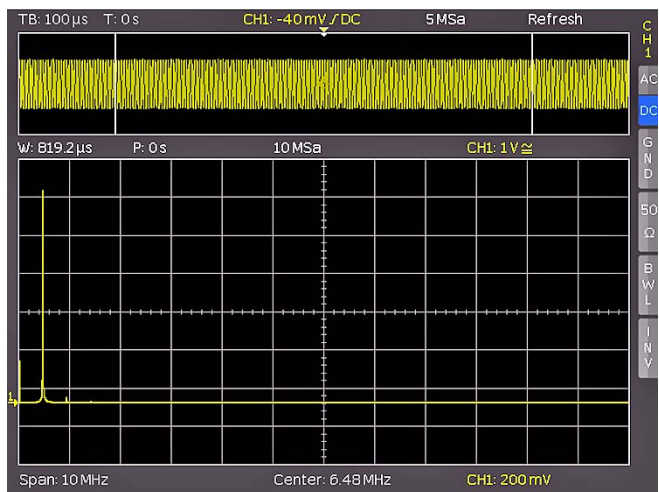

Fig. 9.5: FFT presentation

The information about the settings for the time display will be shown top left, the information about the Zoom and position between both grids and the information about the FFT display (span and center frequency) is shown below the larger area. One of these displays is brighter than the other, after selecting the FFT function this one will be brighter. The large knob in the time base area will set the span, and the small knob X-POSITION the center frequency. By pushing the large knob SCALE TIME/DIV, the display of the time base settings will become brighter, and both knobs will resume their original time base functions. Pushing the large knob SCALE TIME/DIV again will make the Zoom and position setting brighter and both knobs are adjusting the zoom function. The extended FFT menu will open after pushing the key FFT again.

At the top menu the display modes **NORMAL**, **ENVELOPE**, and **MEAN** can be selected. The envelope function will write the maxima spectra of all captured signals on top of each other; this will yield some kind of envelope or area with all FFT results ever obtained. By pushing the respective soft menu key a display of the mean value can be obtained; with the universal knob the number of averages can be chosen in powers of 2 from 2 to 512.

The menu POINTS allow the selection of the number of points used for the FFT calculation. the setting can be done with the universal knob. Possible values are 2048, 4096, 8192, 16384, 32768, 65536 Points.

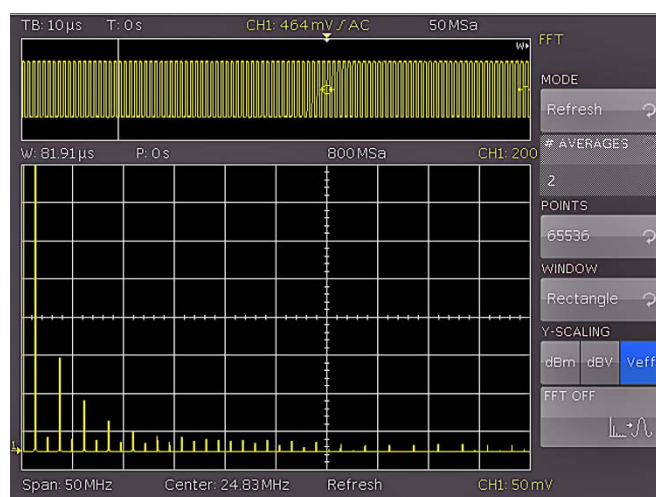

Fig. 9.6: Extended FFT menu

The soft menu item **WINDOW** allows you to select from the following window functions:

- Hanning
- Blackman
- Hamming
- Square

By choosing the menu item **Y-SCALE**, the FFT amplitude can be scaled either linearly (Veff) or logarithmically (dBm, dBV). If another channel is desired as the source for the FFT, this can be selected simply by pushing the respective channel key. In order to terminate the FFT function either push the FFT key again or use the menu key next to **FFT OFF**. The oscilloscope will return to its state before the FFT function was selected.

9.4 Quickview measurements

The Quickview measurements are activated by pushing the key QUICKVIEW in the ANALYZE section of the front panel. The key will light up indicating that the scope responded. This mode offers the following 5 parameters which are directly displayed in the signal:

- Maximum voltage
- Mean voltage
- Minimum voltage
- Rise time
- Fall time

Four additional parameters will be displayed in the right bottom corner of the screen:

- RMS value
- Period
- Frequency
- Peak-to-peak voltage

Using the **AUTO MEASURE** button, there can be two additional parameter selected and displayed.

Only one channel may be activated in the Quickview mode. If another channel is selected by pushing its key, the previously selected one will be deactivated. Now the parameters of the new channel will be shown. By pushing the key again; a Softmenu will open, where the PASS/FAIL mode can be selected. Pushing the QUICKVIEW key again let become active all channels which were activated before the key was pushed and the Quickview mode entered.

9.5 PASS/FAIL test based on masks

In order to access the PASS/FAIL mode please proceed as follows: Press the QUICKVIEW key in the ANALYZE area of the front panel twice, this menu will open, then press the soft menu key PASS/FAIL, this will activate the mode and open a menu for the settings and the use of the mask test feature. Prior to starting a test by pressing the top toggle key TEST ON/OFF, it is necessary to generate or load a mask and to select an action. For the generation of a new mask press the soft menu key next to the menu NEW MASK, a menu will open. By pressing the key COPY CHANNEL, the present signal can be copied into a mask memory. The mask is coloured white and appears as an max. and min. border of the input signal. Using the menu keys Y-POSITION and Y SIZE, this curve can be shifted resp. enlarged in vertical direction. The two menu items WIDTH Y and WIDTH X allow to set the tolerance limits of the mask, the universal knob is used to enter values with a resolution of 1/100 division. The tolerance mask is displayed in white in the background. The mask thus generated can be stored: press the soft menu key STORE, this will open a data file dialogue window, storage is possible either into the instrument memory or onto an USB memory stick. Pressing the MENU OFF key will cause the return to the previous menu. In order to load a mask generated earlier, choose LOAD MASK, a data file dialogue window will open, select the desired mask (file name .HMK) from the internal memory or an USB memory stick. The mask is loaded by pressing the key LOAD and then displayed. Changes to a mask are possible in the menu NEW MASK.

By pressing the key ACTIONS in the PASS/FAIL main menu a menu will be opened which will offer these five possible actions:

- 1 Audible signal if the tolerance limits are exceeded.
- 2 Stop if this happens (from 1st to more than 10000th).
- 3 Pulse output if this happens
- 4 Screen dump if the tolerance limits are exceeded
- 5 Screen dump on a connected printer

The desired action is selected by pressing the respective soft menu key, this menu item will be shown with a blue background. Pressing the MENU OFF key will cause return to the main menu. The test will be started if the soft menu key TEST is pressed.

Below the display window the total number of tests and, in brackets, the total test time are shown in white. The number of successful tests and, in brackets, their percentage are shown in green. The number of failures and, in brackets, their percentage are shown in red. After a test has been started, the soft menu key PAUSE, without function so far, will become activated. If that key is pressed, it will turn blue, and the test will be stopped while signal capturing and the timer remain unaffected. If that key is pressed again, it will become inactive, the tests will be resumed, all event counters continue to count up.

If, however, the tests are stopped by pressing the toggle key ON/OFF, the event and time counters will be stopped. Pressing the key again to ON will cause all counters to be reset to zero and a new test to be started.

The PASS/FAIL mode is left by either pressing the soft menu key PASS/FAIL OFF or by pressing the key QUICKVIEW anew.

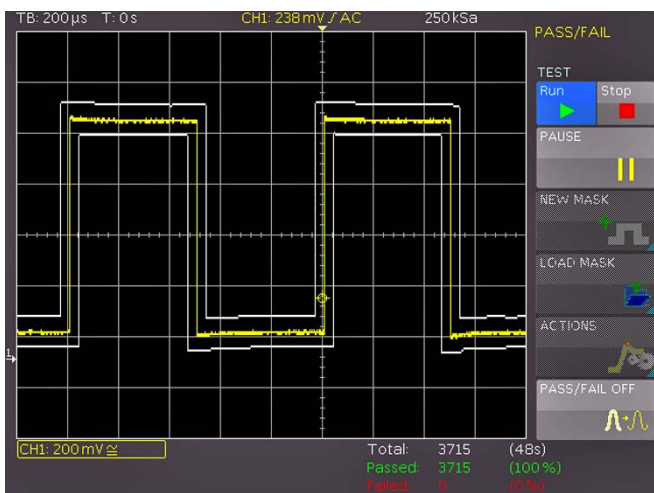

Fig. 9.7: PASS/FAIL mask test.

10 Documentation, storing and recalling

The oscilloscope allows you to store and recall all screen displays, user defined settings (e.g. the trigger conditions and time base settings), reference curves, simple curves and sets of formulas. There is an internal memory for reference curves, instrument settings, and sets of formulas. These data, copies of screen displays and curve data can also be stored on an USB stick. (The USB stick should not be larger than 4 GByte and must be FAT formatted.)

10.1 Instrument settings

Push the key SAVE/RECALL for calling the main menu for storage and load functions. First a listing is shown of the kinds of data which can be stored and loaded. By pushing the key next to the top menu item **INSTRUMENT SETTINGS** this menu will open.

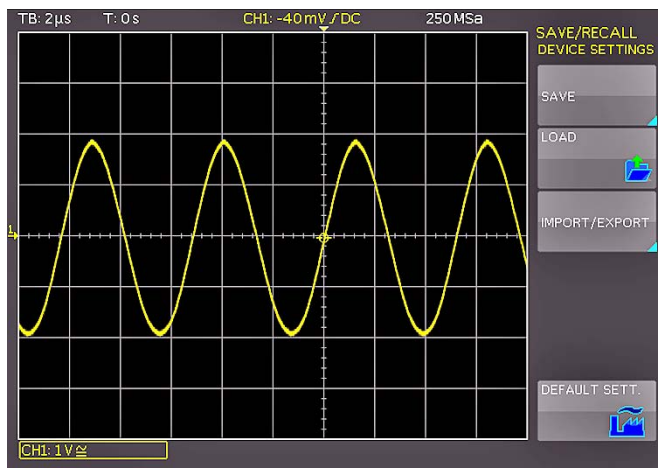

Fig. 10.1: Basic menu for instrument settings

In this menu, by pushing the respective key, it is possible to call the menu for storing, the data manager for loading, and the menu for exporting and importing instrument settings. Additionally, the menu item **STANDARD SETTINGS** will reset the instrument to the factory settings. The storing menu is opened by pushing the STORE key.

Here the storage location (internal memory, front panel USB, rear panel USB) is selected, also a name and a commentary can be added; these will be stored by pushing the soft menu key next to **STORE**. In order to recall stored instrument settings, call the

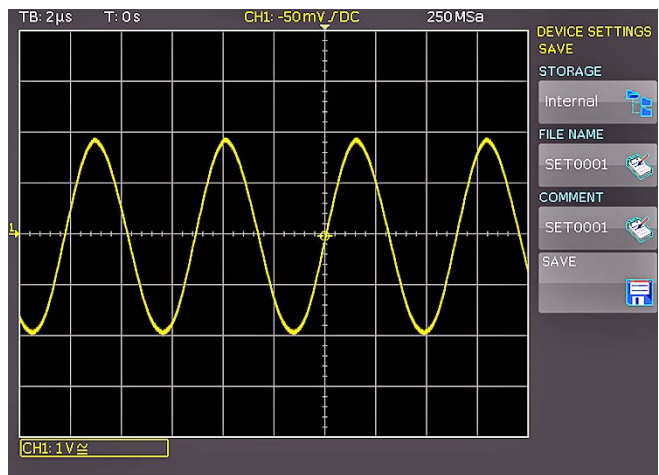

Fig. 10.2: Storing instrument settings

main instrument settings menu and select **LOAD** by pushing the respective soft menu key. The data manager will open, use the menu keys and the universal knob for navigating.

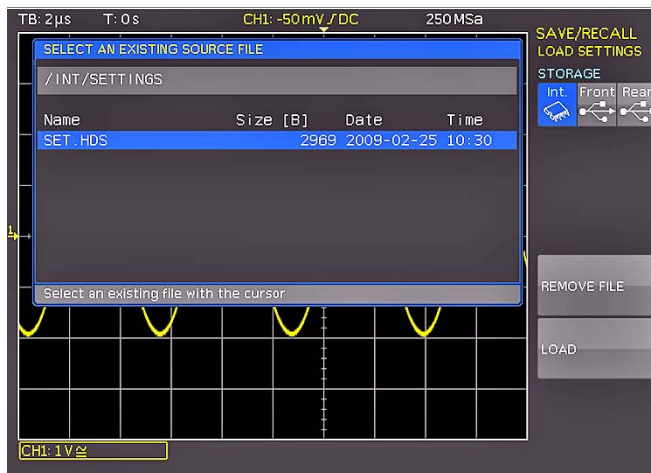

Fig. 10.3: Recalling instrument settings

Here the location is selected from which the settings data are to be loaded. After the selection in the data manager, load the settings by pushing the soft menu key **LOAD**. The data manager also allows you to erase individual settings in the internal memory. If a USB stick is plugged in and has been selected as the location, it is also possible to change or erase directories. In order to export or import instrument settings, a USB stick must be plugged in, otherwise this menu can not be accessed. Provided this is fulfilled, pushing the key next to **IMPORT/EXPORT** will open a menu allowing to copy instrument settings between the internal memory and a USB stick.

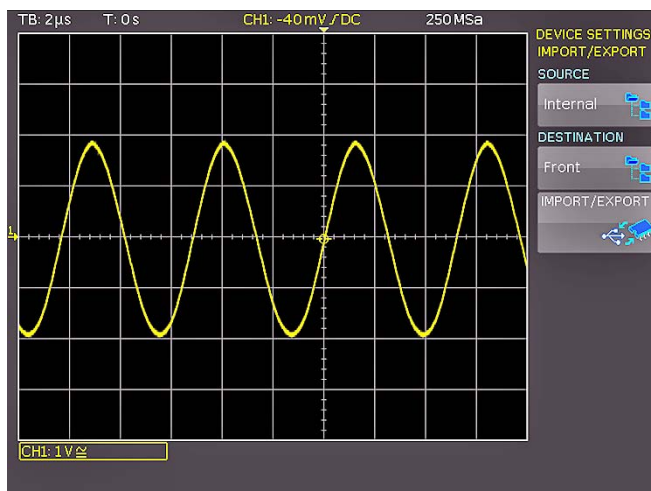

Fig. 10.4: Import/Export menu for instrument settings

The source is selected by pushing the respective key (e.g. INTERNAL), the selection will be indicated by its blue background. Then the destination is selected (e.g. FRONT). By pushing the key next to **IMPORT/EXPORT**, the selected settings data will be copied as previously chosen (in this example from the internal memory to a USB stick). It is possible to copy from the internal memory to the external memory and also between two USB sticks.

10.2 References

References are sets of data which consist of settings information and A/D converter data. These may be stored and recalled internally or externally. There are a maximum of 4 reference

memories (REF1 ... REF4) into which data can be reloaded, the contents of these can also be displayed. The main feature of references is the fact that all information like vertical gain, time base setting, A/D converter data is always stored along with the data proper; this allows to compare the reference with live signals. If the key SAVE/RECALL is pushed and the menu item **REFERENCES** selected, a changeover into the menu **IMPORT/EXPORT** is possible; here the standard menu of the data manager will appear which allows you to copy references between the internal memory and an external USB stick. (See chapter 10.1 for a detailed description.)

For the references, there is a special key REF/BUS in the VERTICAL area of the front panel. If you press this key, it will light up in white and open a short menu. The lowest menu key is subdivided in RE and BU which stands for Reference and Bus. The respective activated setting is indicated by a white background. Choose RE in order to select in this short menu the 4 possible reference curves „RE1 ... RE4“. A reference curve is selected by pressing the respective soft menu key, this reference will be displayed, and the selected reference curve will be marked in the short menu by a white dot. If the reference memory should be empty, a file dialogue window will open in order to load a reference curve from the internal memory

The store and load menu will be opened by first pushing the key REF and then the key MENU in the VERTICAL section of the front panel.

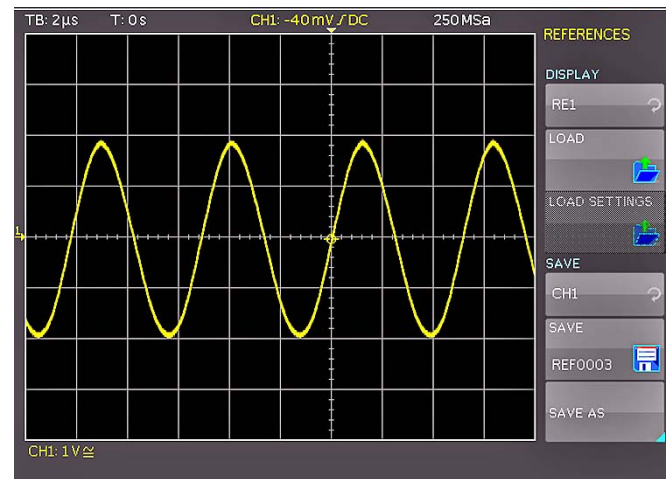

Fig. 10.5: Loading and storing of references

After activating the top menu item with the respective key, the desired reference into which the data shall be loaded can be selected with the universal knob. In order to select the reference curve to be loaded, push the menu key **LOAD** and select the desired data in the data manager. If the data were, e.g., loaded into the „REF1“ curve in order to store a reference, select the channel (push the key next to **STORE** and select the channel with the universal knob), check whether the selected name for the data is the desired one, and store the reference by pushing the soft menu key next to **DATA NAME**. If another name and/or a commentary is desired, push the key next to **STORE AS** in order to access the appropriate menu.

This standard menu allows you to select the location, the data name, and a commentary and to store all of this by pushing the respective menu key.

10.3 Curves

In addition to references, the pure A/D converter data can be stored, however, only on external USB sticks, not internally.

The following formats are available:

Binary format:

A binary data set may contain bytes of any length. The curves will be stored without any time information.

CSV (Comma Separated Values):

CSV data sets store the curves in tables, the lines are separated by commas.

HRT (HAMEG Reference Time):

Data sets with this code contain data of curves vs. time. If a curve was stored in this format, it can be used in the reference menu. With the HRT format it is also possible to generate data sets which may be reloaded into the oscilloscope via the reference menu.

In order to store curves, push the key **SAVE/RECALL** and select in the main menu the item **CURVES** by pushing the respective soft menu key.

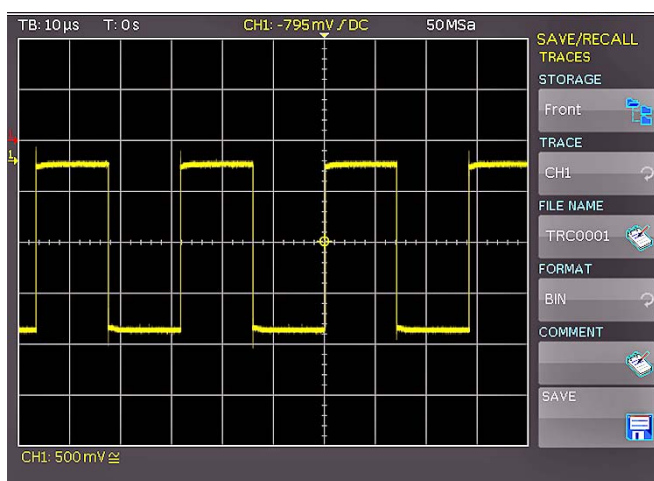

Fig. 10.6: Menu for storing curves

In this menu which will open, the top item allows the selection of the front or rear panel USB port. This choice is only possible if the instrument recognized a USB stick at the designated port. If a stick is present and the port selection done by pushing the respective soft key, the first time this happens, the data manager will appear with the associated menu. Here, a listing of destinations can be selected or generated. Confirm the selection of the destination listing by pushing **OK**, this will recall the menu for storing curves. Pushing the soft key next to the second menu item (**CURVE**) will activate this function as indicated by the blue background: now the channel can be selected from which the curve shall be taken by turning the universal knob. Only channels which have been activated are eligible. Pushing the menu key next to **DATA NAME** will open the menu for entering names: in order to do this use this menu and the universal knob to enter the desired name which will be stored by pushing **ACCEPT**. This will recall again the menu for storing curves.

Now push the soft key **FORMAT**, this will open a window for selecting the format. The selection is performed again with the universal knob. Additionally, a commentary can be stored along with a curve. This is done by pushing the menu key next to **COMMENTARY**, this will open a window for the entry. After entering the commentary and storing it by pushing **ACCEPT**, again the menu for storing curves will appear. After completion of all these entries, pushing the menu key next to **STORE** will store the curve according to the selected settings.

10.4 Screenshots

The most important method of storing for documentation purposes is the screen photo. At least one USB stick must be connected, only then will any settings regarding the destination, the name, the format and the colour mode be possible. Push the keys **SAVE/RECALL** and **SCREENSHOTS** for opening the appropriate menu.

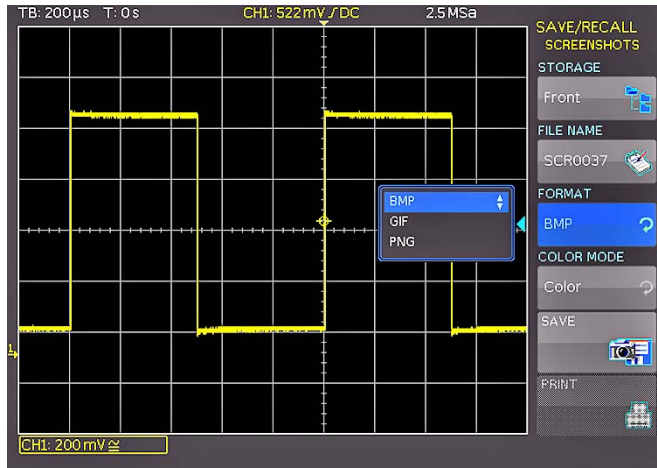

Fig. 10.7: Menu for screen shots

Also in this menu the destination (according to the USB sticks connected) can be selected with the top menu key. When this is done the first time, the data manager will appear in order to either select or generate a destination listing. After the entry of this information, the **SCREEN SHOT** storing menu will reappear. The second menu item **DATA NAME** allows you to enter a name with the respective name entry menu which will open automatically upon selecting this menu item. If **FORMAT** is selected with the respective menu key, these formats will be offered and can be selected with the universal knob:

BMP = Windows Bitmap (uncompressed format).

GIF = Graphics Interchange Format

PNG = Portable Network Graphics

By selection of the soft menu item **COLOUR MODE**, the universal knob will allow to select **GREY SCALE**, **COLOUR** or **INVERSION**. If **GREY SCALE** is selected, the colours will be converted into a grey scale upon storing. If **COLOUR** is selected, the curve will be stored in colour as it is shown on the display. If **INVERSION** is selected, the curve will be stored in colour but with a white background.

When the key next to the menu item **STORE** is pressed, the present display will be stored immediately to the location selected with the name selected and the format selected.

PLEASE NOTE: If you intend to print, stop signal capturing by pressing the **RUN/STOP** key first in order to guarantee a correct printout with complete curves.

10.5 Sets of formulas

Pushing the key **SAVE/RECALL** will open the main menu where a menu item is called **FORMULARIES**, selection of this menu item will call a submenu which allows you to move sets of formulas between the internal memory and the USB stick as well as to import or export such sets. How this is done was already described in chapter 9.2.

10.6 Definition of the FILE/PRINT key

The key FILE/PRINT on the front panel allows you to store curves, screen shots, screen shots with settings, by just pushing it. However, it is required that the necessary settings for the destination, the name etc. have been previously defined as described in the preceding chapters. In order to open the settings menu of the FILE/PRINT key, push the SAVE/RECALL key for calling its main menu, then select the menu item **FILE/PRINT**.

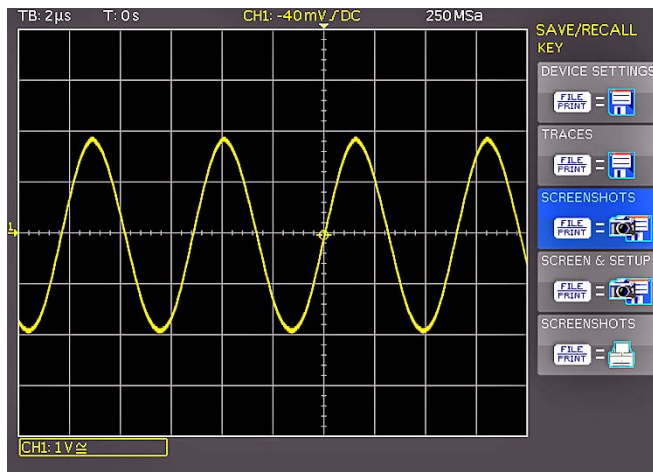

Fig. 10.8: Definition of FILE/PRINT key

By pushing the respective menu key, it is possible to define the action which shall take place upon pushing the key, the following actions are available:

- **DEVICE SETTINGS** stores settings of the instrument
- **TRACES** stores curves
- **SCREEN SHOT** stores screen photos
- **SCREEN & SETUP** stores screen photos and settings
- **PRINT** prints directly to a postscript or some PCL or PCLX compatible printer

After the selection of the desired action by pushing the respective key, the acceptance will be confirmed by the blue background. By pushing MENU OFF the menu will be switched off.

11 Component test

11.1 General

The oscilloscopes HMO72x...HMO202x have a built-in component tester. This can be activated by pushing the XY/CT mode button and switch on CT at the upcoming menu at the top. The unit under test is connected to the two contacts below the screen. After switch on the component tester mode, the Y preamplifiers and the time base are disconnected. While using the component tester, signals may be present at the inputs as long as the unit under test is not connected to any other circuit. It is possible to test components remaining in their circuits, but in such cases all signals must be disconnected from the front panel BNC connectors! (See the following paragraph: „Test in circuits“). Two cables with 4 mm plugs are necessary to connect the unit under test to the component tester. After completion of the component test pushing the lower soft key COMP. TEST OFF leave the component tester mode and resume normal scope operation.

 **As outlined in the chapter Safety, all measurement connectors are connected to the mains safety earth (in proper operation). This implies also the COMP.TESTER contacts. As long as individual components are tested, this is of no consequence because these components are not connected to the mains safety earth.**

 **If components are to be tested which are located in circuits or instruments, these circuits resp. instruments must be disconnected first under all circumstances! If they are operated from the mains, the mains plug of the test object has to be pulled out. This ensures that there will be no loops between the scope and the test object via the safety earth which might cause false results.**



Only discharged capacitors may be tested!

The test principle is a generator within the HMO generates a 50 Hz or 200 Hz ($\pm 10\%$) sine wave which feeds the series connection of the test object and a sense resistor.

If the test object has only a real part such as a resistor, both voltages will be in phase; the display will be a straight line, more or less slanted. Is the test object short-circuited, the line will be vertical (no voltage, current maximum). If the test object is open-circuited or missing a horizontal line will appear (voltage, but no current). The angle of the line with the horizontal is a measure of the resistance value, allowing for measurements of resistors between Ω and $k\Omega$.

Capacitors and inductors cause phase shift between voltage and current and hence between the voltages. This will cause displays of ellipses. The location and the form factor of the ellipse are determined by the apparent impedance at 50 Hz (resp. 200 Hz). Capacitors can be measured between μF and mF .

- An ellipse with its longer axis horizontal indicates a high impedance (small capacitance or large inductance)
- An ellipse with its longer axis vertical indicates a low impedance (large capacitance or small inductance)
- An ellipse with its longer axis slanted indicates a relatively

large resistive loss in series with the impedance of the capacitor or inductor.

With semiconductors the transition from the non-conducting to the conducting state will be indicated in their characteristic. As far as is possible with the available voltages and currents the forward and backward characteristics are displayed (e.g. with zener diodes up to 9 V). Because this is a two-pole measurement, the gain of a transistor can not be determined, however, the B-C, B-E, C-E diodes can be measured.

 **Please note that most bipolar transistors can only take an E-B voltage of approx. 5 V and may be damaged if this is exceeded, sensitive HF transistors take even much less!**

With this exception the diodes can be measured without fear of destruction as the maximum voltage is limited to 9 V and the current to a few mA. This implies, however, that a measurement of breakdown voltages > 9 V is not possible. In general this is no disadvantage because, if there is a defect in a circuit, gross deviations are to be expected which will point to the defective component.

Rather exact results may be achieved if the measurements are compared to those of intact components. This is especially true for semiconductors. The polarity of diodes or transistors can thus be identified if the lettering or marking is missing.

Please note that with semiconductors changing the polarity (e.g. by exchanging the COMP.TESTER and ground terminals) will cause the display to rotate 180 degrees around the screen center. More important in practice is the quick determination of plain shorts and opens which are the most common causes of requiring service.

 **It is highly recommended to observe the necessary precautions when handling MOS components which can be destroyed by static charges and even tribo electricity. The display may show hum if the base or gate connection of a transistor is open, i.e. it is not being tested. This can be verified by moving a hand closeby.**

pecially if those are fairly low impedance at 50 Hz /200Hz – there will be mostly great differences compared to individual components. If circuits of the same type have to be tested often (service), comparisons with intact circuits may help again. This is also quickly done because the intact circuit has not to be functional, also it should not be energized. Just probe the various test points with the cables of the component tester of the unit under test and the intact unit and compare the screen displays. Sometimes the unit under test may already contain an intact portion of the same type, this is e.g. the case with stereo circuits, push-pull circuits or symmetrical bridge circuits. In cases of doubt one side of the dubious component can be unsoldered, and this free contact should then be connected to the COMP.TESTER contact which is not identified as the ground contact. This will reduce hum pick-up. The contact with the ground symbol is connected to the scope chassis and is thus not susceptible to hum pick-up.

11.2 In-circuit tests

They are possible in many cases but deliver rarely clear results. By paralleling of real or complex impedances – es-

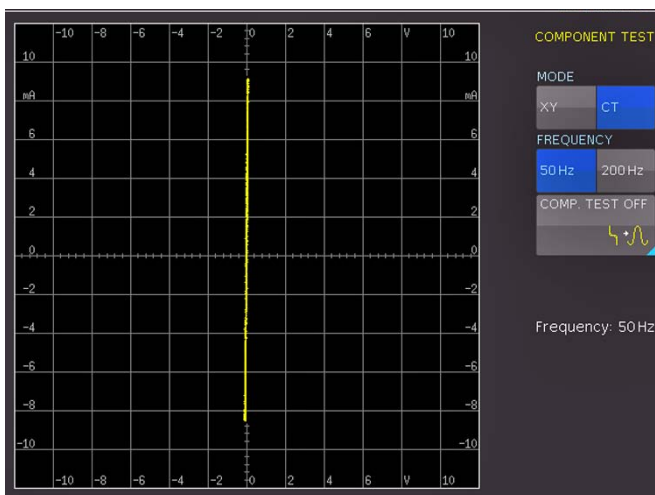



Fig. 11.1: Component tester at short

12 Mixed Signal Operation (optional)

All HMO series instruments are provided with the connector for the HO3508 logic probe necessary to add 8 digital logic channels. The firmware required for Mixed Signal operation is already contained in each HMO, only the HO3508 active logic probe need to be bought and connected. With the 4-channel oscilloscope activation of the Pod will deactivate the analog channel 3. Therefore at the MSO mode are 3 analog channels plus 8 digital logic channels available.

12.1 Logic trigger

 You may test all the settings without a logic probe connected, however, the functions will only be effective with a HO3508 probe connected.

By selecting LOGIC trigger in the soft menu after pushing the key TYPE the trigger source will be routed to the digital logic inputs. If you now push the key SOURCE, a soft menu will open up which offers further settings and a window for a display. (refer to Fig. 12.1).

The top soft menu is used to preselect the logic channel for which the trigger condition is to be defined. This is done with the universal knob. The selected digital input will be marked with a blue background in the general menu; in the field the trigger level (high) H or (low) L or (any) X will be indicated. The selection of the logic level is done with the respective soft menu key. The selected level will also be marked with a blue background in the soft menu. Another menu selects the logic combination of the digital logic inputs; they can be combined by logic AND, OR. If AND is selected, then both conditions must be met simultaneously for the result to go high H. If OR is selected either one or both conditions must be met. The last item in this menu is called **TRIGGER ON**. With the soft menu key **TRUE** or **FALSE** can be chosen. This allows you to preselect whether the trigger shall be generated at the beginning (TRUE) or the end („FALSE“) of the logic condition.

After selecting the desired set of conditions, you may push FILTER for more settings. A soft menu will have opened which allows you to limit the trigger TRUE condition further in time (in this menu that condition will appear which you choose in the SOURCE menu). A time limit can be added by pushing the top soft menu key. (This functionality will be available with a firmware 3.0 or later.) The reference criterion can be selected in the menu field below by the respective soft key.

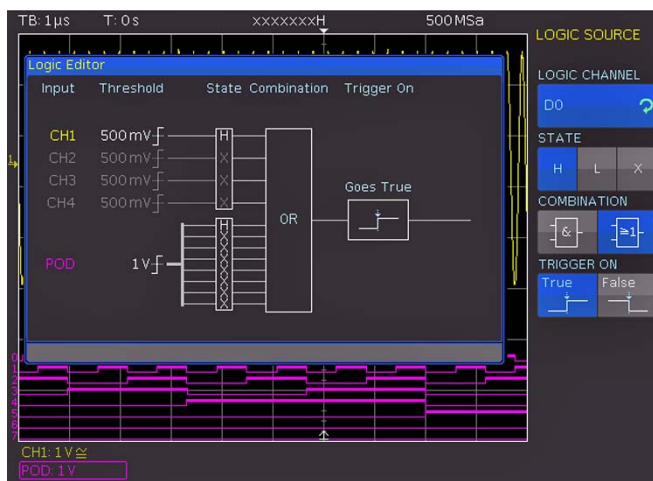

Fig. 12.1: Logic trigger menu

These 6 criteria are available:

$t_i \neq t$: The duration of the bit pattern which will generate the trigger is unequal to the reference time.

$t_i = t$: The duration of the bit pattern which will generate the trigger is equal to the reference time.

$t_i < t$: The duration of the bit pattern which will generate the trigger is smaller than the reference time.

$t_i > t$: The duration of the bit pattern which will generate the trigger is greater than the reference time.

$t_1 < t_i < t_2$: The duration of the bit pattern which will generate the trigger is smaller than the reference width t_2 and greater than the reference width t_1 .

$\text{not}(t_1 < t_i < t_2)$: The duration of the bit pattern which will generate the trigger is greater than the reference width t_2 and smaller than the reference width t_1 .

By the same procedure as with pulse trigger the reference time is adjusted with $t_i \neq t$ and $t_i = t$ by turning the universal knob after pushing the soft key next to TIME. By selecting DEVIATION the universal knob allows you to define a tolerance interval. If $t_i < t$ or $t_i > t$ was chosen only one limit may be set. Both options with two references (t_1 and t_2) can be set due to pressing the respective soft key and turning the universal knob.

If you desire to change the levels for logic ONE or ZERO you will have to choose the channel menu. Select the appropriate POD (with the key CH3/POD). If the logic mode was already selected, you will see the digital logic channels, and the display will show in its channel information section the framed message: „POD1:xxxV“. If information about the analog channel 3 is shown there, push the key next to the lowest soft menu entry (before pushing the key it have „CH“ coloured with the Channel color, afterwards it is „PO“ coloured). This will activate the digital channels. If you now push the key MENU in the VERTICAL section of the front panel, you will be able to select from 5 predefined logic levels, three of them are fixed for TTL, CMOS, and ECL, two are user definable and may be set from -2V to +8V with the universal knob after pushing the respective key.

12.2 Display functions of the logic channels

With the four channel HMO the short menu in the channel settings is used to switch an analog channel to a digital channel. If you find there data belonging to the analog channels 3 and 4, press the key next to the lowest soft menu entry. This is a double key: the upper designation CH stands for channel, the lower one PO for pod. Pressing this key will alternate between those two modes. The mode which is presently active will have its background shown in the colour of the respective channel. Activate the Pod here. At the two channel units you can activate the logic channel simply by pressing the POD button.

If you now press the MENU key in the VERTICAL area of the front panel, you can select one of five preset logic level settings. With the logic channels, a logic ONE will be indicated by a bar of two pixels width, a logic ZERO will be one pixel wide. The information field in the lower left corner of the screen will show the actual logic levels selected next to the name POD.

The Y positions and the size of the logic channel displays can be chosen as customary and known from analog channel operation with the appropriate knobs Y-POSITION and SCALE VOLTS/DIV (provided the soft menu key „0/7“ was selected as indicated by a blue background). If less than 8 logic channels

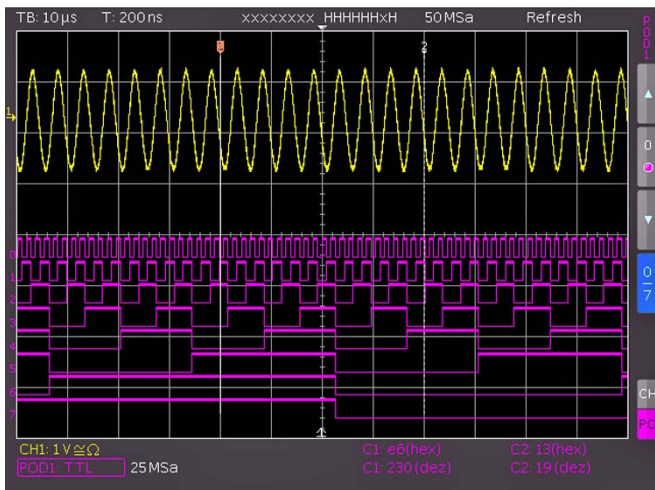

Fig. 12.2: Logic channels' settings display

are to be displayed, or if the position of individual channels is to be changed, this can be done in the short menu in conjunction with the soft menu keys and the Y POSITION and SCALE VOLTS/DIV controls. In order to do this, push the soft menu key next to **CTRL**: this will allow you to control the Y position and the size of the logic channel display with the knobs. The name of which will be shown above the menu entry (in this example number 0). The selection of the channels is done with the soft keys „Arrow Up” and „Arrow Down”. By this method all channels may be individually positioned and sized. If POD was activated and if the MENU key in the VERTICAL section of the front panel was pushed, the menu for setting the trigger levels will be shown: 5 preprogrammed levels are available, 2 of which are user definable.

On page two of this menu there is the possibility to name each digital channel. The process is the same as described in chapter 4.6.

There is also a possibility to combine several digital channels to form buses which will then be displayed on the screen in tables. Basically two independent buses are possible, e.g. an 8 bit address and an 8 bit data bus may be combined. In order to access the bus settings, press the REF/BUS key and then the MENU key in the VERTICAL area of the front panel.

A menu will open, the top key allows to select B1 or B2 (the activated one will have a blue background). The key below allows to select the type of bus. For the parallel bus PARALLEL and PARALELL + CLOCK are available. After selection of the bus type, press the soft menu key CONFIGURATION which will open the submenu for the bus settings. After pressing the top menu key BUS WIDTH, the desired bus width can be selected with the universal knob from 1 to 16 bits. The window showing the table of bits will be dynamically adapted. Now press the soft menu key SOURCE, the universal knob is used to link a physical source to the bit selected. In the window, the entry which is presently being set will be shown with a blue background. On the left side of the table in the window, the bus bits are shown in a fixed order, at the top there is D0 which is the LSB of the bus. The universal knob is used to link the bus bit selected to a real logic channel. Example: The bus bit D0 is linked to logic channel D9 (this is equivalent to the LC9 input on POD2).

There are no restrictions to the linking, it is also possible to partly use identical logic channels in the two buses. In order to select the individual bits in the table, use the keys PREVIOUS BIT and NEXT BIT, then use the universal knob for the linking to the logic channel.

If you chose the bus type PARALLEL + CLOCK, the lower two soft menu keys are reserved for the source and the slope of the clock. For selecting the source of the clock, press the key CLOCK and use the universal knob for selecting the logic channel which carries the clock. The key SLOPE will offer RISING, FALLING and BOTH in that order and start all over. The activated selection will be shown with a blue background. Pressing the MENU OFF key will return you to the BUS menu. There is another menu item DISPLAY SETTINGS. In this submenu selecting DISPLAY will allow to select the following decoding formats with the universal knob:

- Binary
- Hexadecimal
- Decimal
- ASCII

The decoded values will be shown in the tables of the buses in the format selected.

The next lower soft menu key may be used to switch the individual bits of the bus on in the table display. The BUS short menu will be displayed upon pressing the MENU OFF key twice. The two upper soft menu keys can be used to switch the bus display on or off. If a bus is switched on, this will be indicated by a white dot in the short menu. In order to vary the position or the size of a bus, it is first selected in the menu which is shown by a blue background of the key. The position control knob is used to position the bus display on the screen. The size of the table display can be varied with the VOLTS/DIV knob. This may be especially helpful in case of the binary format, because it allows to display the complete value in up to 4 lines even with short tables.

12.3 Cursor measurements for the logic channels

If the logic channels were activated, some parameters may be measured with the cursors. For all activated logic channels of a POD these measurements are available: TIME, RATIO X, V-MARKER. The results will be as follows:

TIME:

The time position of both cursors relative to the trigger time position will be indicated; also the time difference between the two cursor positions from which the frequency is calculated.

RATIO X:

In this mode 3 cursors are used. The time ratios between the first and the second and between the first and the third will be shown. The presentation will be in floating point format, in percent, in degrees, and in radians.

V-MARKER:

With the logic channels the logic value of the selected POD will be measured at the position of the respective cursor and shown in hexadecimal and decimal formats.

13 Serial bus analysis (optional)

The HMO series with option H0010 can be used for triggering and decoding of I²C, SPI and UART/RS-232 buses on the digital inputs (Option H03508) or the analog inputs. The option H0010 also allow two serial busses decoded at the same time.

The Option H0011 can be used for triggering and decoding of I²C, SPI and UART/RS-232 buses on the analog inputs only. The option H0011 allow only one serial bus decoded at the same time.

These options will become usable with a software licence key. This key will either be installed during manufacturing or by the user when he installs an update as described in chapter 2.10.

In order to establish the settings of the trigger and decoder functions, it is necessary to first define a bus. A maximum of 2 buses B1 and B2 can be defined. First press the key BUS/REF in the VERTICAL area of the front panel, a short menu will open. Use the lowest soft menu key to either select whether references or buses are to be defined. This is a toggle key which alternates between those two possibilities RE (reference) and BU (bus). The activated function is indicated by a white background. Here select BU. Then press the MENU key in the VERTICAL area of the front panel. A menu will open, the top soft menu key allows to choose either B1 or B2.



Fig. 13.1: Bus definition menu

By pressing the soft menu key BUS TYPE the type of bus can be selected from the available ones. If the option H0010/H0011 is installed, there will be these options:

- Parallel
- Parallel clocked
- SPI 2 wire
- SPI 3 wire
- I²C
- UART

The soft menu key CONFIGURATION will call a menu which is dependent upon the bus type selected. These menus are described in the chapters of the respective bus configurations.

The menu called by pressing DISPLAY SETUP is the same for all buses, it allows to select the decoding format. The following formats are available:

- Binary
- Hexadecimal
- Decimal
- ASCII

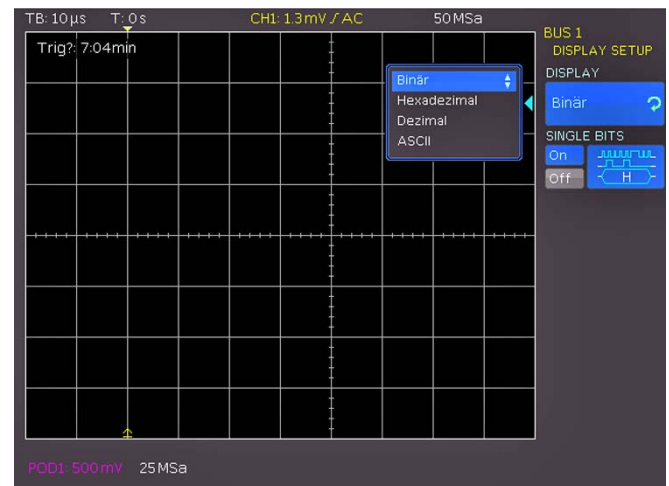

Fig. 13.2: Menu for the selection of the decoding format

Use the soft menu key SINGLE BITS to switch the display of individual bit lines of the bus display (above the table display) on or off.

In the Bus setting menu there is a softmenu which allow to enter a name for a bus. The process is the same as for naming a channel and is described in chapter 4.6.

13.1 I²C bus

The I²C bus is a two-wire bus (clock and data) which was developed by Philips and which allows data rates of up to 3.4 Mbits/s.

13.2 I²C Bus configuration

Remark: prior to configuring the bus, make sure that you chose the correct logic level for the logic inputs (as described in chapter 12.1) resp. the analog channel (as described in chapter 4.5). The default setting for both is 500mV.

In order to decode the I²C bus, it is only necessary, when configuring the bus, to define which logic channel carries the clock and which the data. These settings are performed after the selection of the bus type I²C in the bus menu by subsequently pressing the soft menu key CONFIGURATION. A menu will open, select the top soft menu key CLOCK SCL and use the

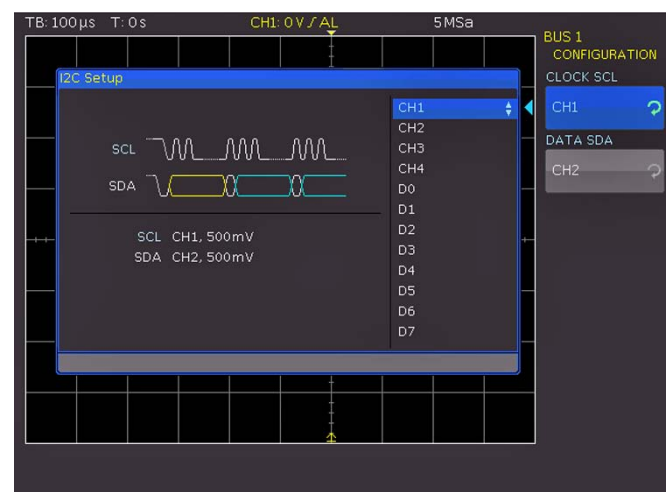

Fig. 13.3: Menu for the definition of the I²C sources.

universal knob to select the appropriate channel. The definition of the data channel is performed in the same manner after pressing the soft menu key DATA SDA. For checking these entries a small window will show the actual settings while in this submenu.

(If only the H0011 is installed, only the analog channel can be as sources selected, if the H0010 is installed analog an logic channels are available.)

All menus will close upon pressing the MENU OFF key twice.

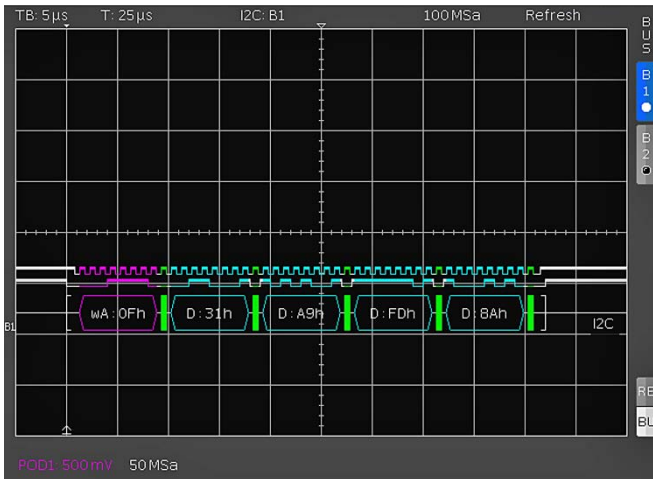

Fig. 13.4: I2C message, hexadecimal decoded.

Certain portions of the I2C messages will be displayed in colour in order to facilitate recognition. If the data lines are selected together with the table presentation, the respective areas will also be displayed in colour as follows:

- Read address: Yellow
- Write address: Magenta
- Data: Cyan
- Start: White
- Stop: White
- No acknowledge: Red
- Acknowledge: Green

13.3 I2C bus triggering

After configuring the bus, it will be possible to trigger on various events. To choose the trigger type, press the key TYPE in the TRIGGER area of the front panel and select the soft menu key SERIAL BUSES. Subsequently press the key SOURCE in the

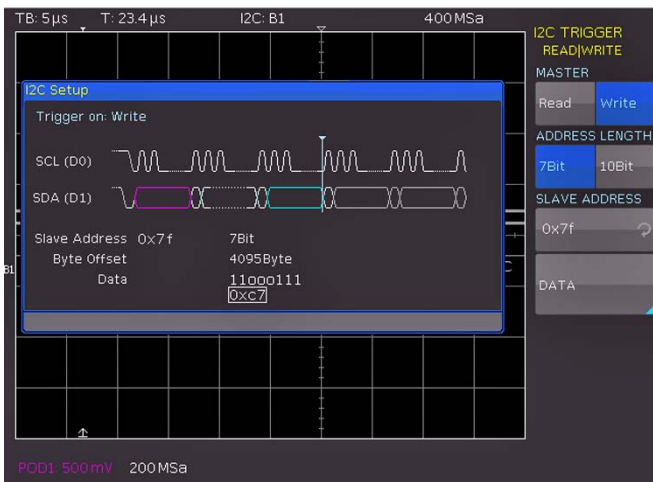

Fig. 13.5: I2C READ/WRITE trigger menu

TRIGGER area and select the I2C bus. (This will only be available if it was defined before.) After pressing the key FILTER in the TRIGGER area all possible trigger types will be presented.

It is possible to trigger on the START, STOP of all messages as well as on NEW START and NOT-ACKNOWLEDGE conditions. For further trigger options press the soft menu key READ/WRITE. A menu opens which offers the choice of triggering on READ or WRITE conditions and whether the address length is 7 or 10 bits.

After pressing the soft menu key SLAVE ADDRESS the universal knob can be used to select a 7 or 10 bit address on which shall be triggered.

Pressing the soft menu key DATA will open a submenu which allows to enter data in addition to the address.

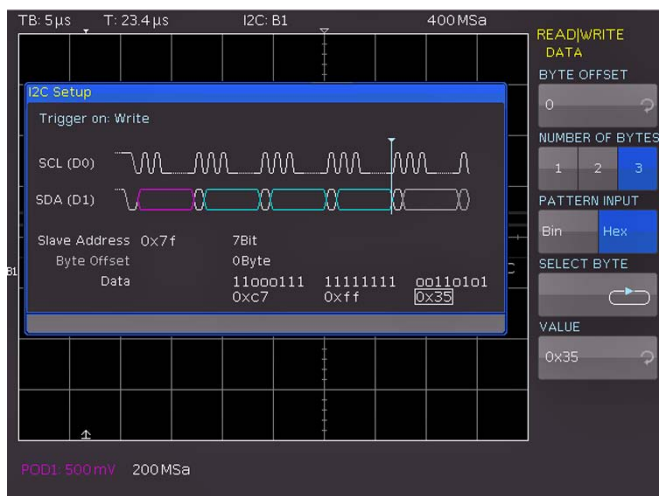

Fig. 13.6: I2C data Trigger menu

It is possible to trigger on a maximum of 24 bits (3 bytes) of data which may have an offset from 0 to 4095 with respect to the address. In order to select an offset, press BYTE OFFSET. In most cases the offset will be zero if it is desired to trigger on the maximum of 24 first bits following the address. Use the soft menu key NUMBER OF BYTES in order to select whether 1, 2 or 3 bytes of data should be entered. The entry may be binary or hexadecimal which is selected with the soft menu key INPUT. If binary entry was selected, the individual bits may be chosen with the soft menu key BIT and the universal knob. With the soft menu key DEFINITION you can choose for each bit whether it shall be 1, 0 or X (don't care). If hexadecimal entry was chosen, the soft menu key VALUE and the universal knob are used to define the value of each byte. The soft menu key BYTE is used to switch from byte 1 to byte 2 and to byte 3 (if the byte number chosen was 3). In the display window of the trigger conditions the presently active byte will be framed in green.

By pressing the MENU OFF key three times all menus will be closed, and the oscilloscope will trigger on the address and data entered.

13.4 SPI bus

The SPI bus was developed by Motorola (today: Freescale), however, it is not formally standardized. In general, it is a bus with a clock and data lines and a select line. If only one master and one slave are present, the select line may be deleted; this is also called SSPI (Simple SPI).

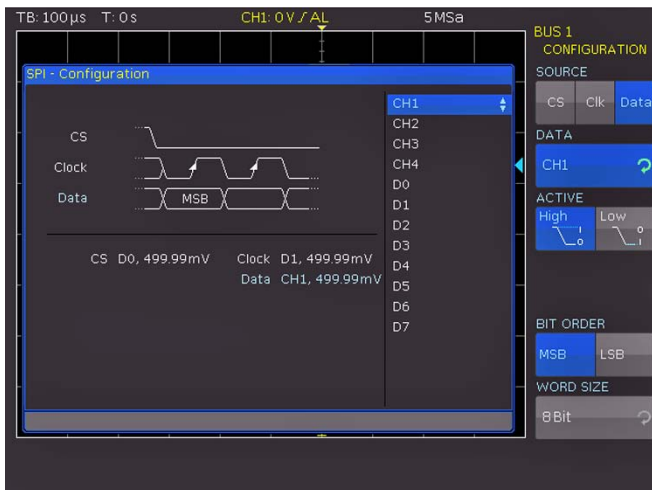

Fig. 13.7: Menu for the SPI bus definition

13.5 SPI bus definition

For the correct decoding of a SPI bus some settings are required. The first definition pertains to the type of bus: whether it is a 2-wire (without chip select) or a 3-wire system (with chip select). This is done in the bus configuration menu when selecting the bus type: for a 2-wire system choose the entry SSPI, for a 3-wire system SPI. Subsequently open the SPI configuration menu by pressing the key CONFIGURATION.

The top soft menu key SOURCE is used to define the respective digital channels for chip select, clock and data. (In case of a 2-wire system choose the dead time instead of a chip select source.) Pressing this soft menu key will present one of the three choices (the selected one will be shown with a blue background), in the menu which will open, use the universal knob to select the input channel. (If H0011 is installed, only analog channels are available, if H0010 is installed, both analog and logic channel are allowed.)

In case of the two channel units and installed H0011 and 3 wire SPI, the Chip select signal must be connected to the external trigger input.

The third soft menu key also allows (in addition to linking the inputs to the signals) the following settings:

- CS: Chip select high or low active, the standard is low active
- CLK: data will be stored with rising or falling slope, rising is the standard
- DATA: high or low active, high is the standard

The soft menu key BIT ORDER defines whether the data of the messages shall start with the MSB or the LSB.

The soft menu key WORD SIZE is used to set the number of bits of a message, use the universal knob to select any number from 1 to 32.

13.6 SPI bus triggering

Following the bus configuration the trigger conditions have to be defined in order to be able to trigger on various events. Press the key TYPE in the TRIGGER area of the front panel and select the key TYPE in the TRIGGER area of the front panel and select the soft menu key SERIAL BUSES. Subsequently press the key SOURCE in the TRIGGER area and select the SPI bus. (It will only show up if it was previously defined.) Pressing the key FILTER in the TRIGGER area will present all possible trigger options.

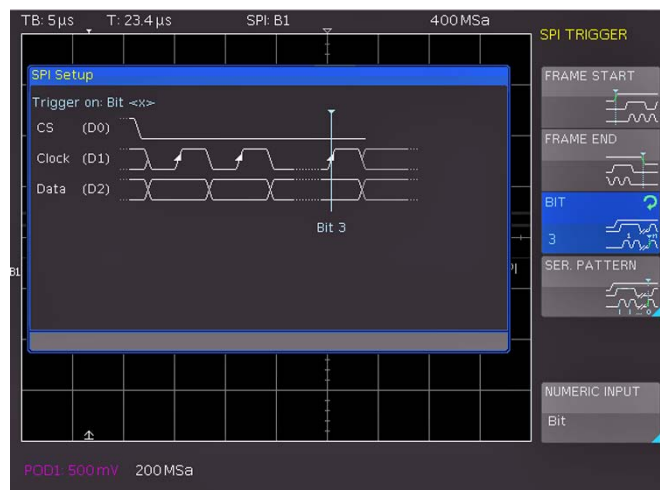

Fig. 13.8: SPI trigger menu

Triggering is possible on the FRAME START, the FRAME END and in a preselected BIT. (Press the soft menu key BIT and use the universal knob for the selection of the desired bit number.)

Further trigger possibilities will become available after pressing the soft menu key SER. PATTERN, a menu will open which allows to provide for a bit offset which may exist (values from 0 to 4095 are possible). It also permits to define the number of bits per message (values from 1 to 32 bits are possible) and to set each of the bits defined.

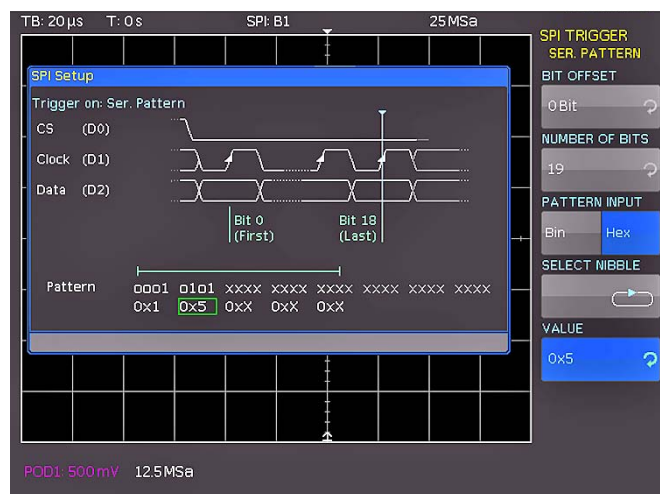

Fig. 13.9: SPI data trigger menu.

The input of the serial bit stream may be binary or hexadecimal, this will be defined with the soft menu key PATTERN INPUT. If binary input is selected, the individual bits can be selected with the soft menu key SELECT BIT and the universal knob. The soft menu key VALUE is used to define whether the bit should be 0, 1 or X (don't care). If hexadecimal input is selected, the soft menu key VALUE and the universal knob are used to set the value of each nibble (4 bits). The soft menu key NIBBLE switches from nibble to nibble. The presently active nibble will be marked with a green frame. All menus will be closed by pressing the MENU OFF key three times. The oscilloscope will now trigger on the bit stream defined.

13.7 UART/RS-232 bus

The UART (Universal Asynchronous Receiver Transmitter) bus is a general bus system and the base for many protocols. The

RS-232 protocol is one of them. It consists of a frame with a start bit, 5 to 9 data bits, a parity bit and a stop bit. The stop bit can assume the nominal length of a bit, 1.5 times or twice that length.

13.8 UART/RS-232 bus definition

In order to decode the UART bus, it is first necessary to define which logic channel shall be connected to the data line. Open the bus menu, select the bus type UART and then press the soft menu key CONFIGURATION. A menu will open, press its top soft menu key DATA SOURCE and use the universal knob to select the channel. (If H0011 is installed, only analog channels are available, if H0010 is installed, both analog and logic channel are allowed.) The soft menu key ACTIVE alternates between high and low, the selection is marked by a blue background (for RS-232 select low). The key SYMBOL SIZE and the universal knob are used to select 5 to 9 bits. The key PARITY allows to select no, even or odd. The last soft menu item on page 1 defines the length of the stop bit as nominal, 1.5 times or twice.

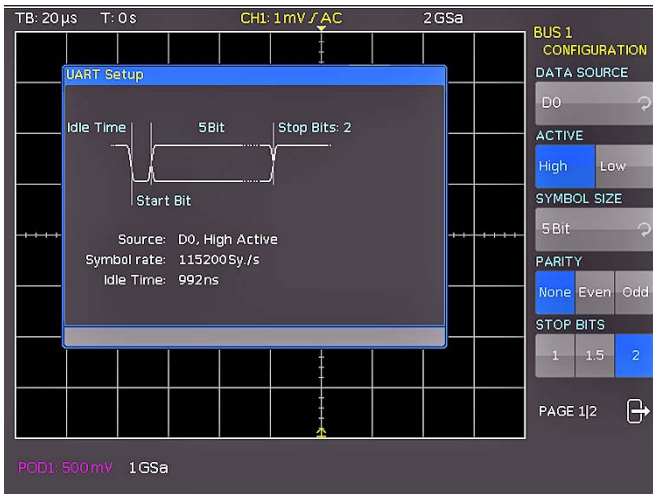

Fig. 13.10: Page 1 of the UART bus definition menu.

On page 2 of the definition menu the bit rate can be chosen.

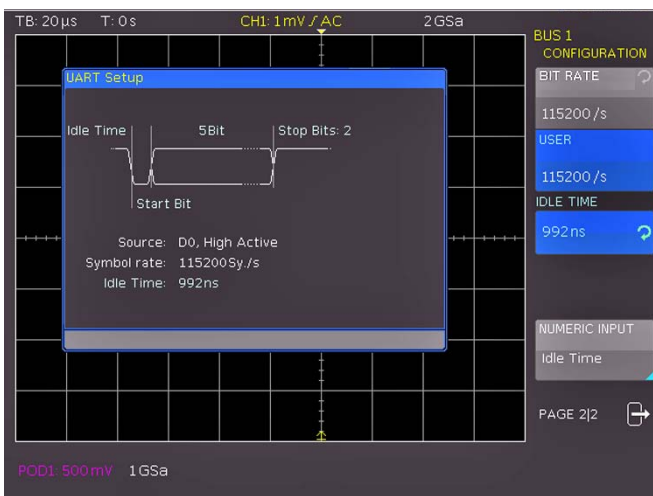

Fig. 13.11: Page 2 of the UART bus definition menu

After pressing the soft menu key BIT RATE the universal knob is used to select the standard symbol rates from 300 to 115200 symbols per second. If a different symbol rate should be required, press the soft menu key USER and use the universal knob or the numerical input to enter the desired value.

The last setting to be performed is the dead time between the last stop bit and the next start bit. Press the soft menu key IDLE TIME and use the universal knob or the numerical input for entering.

13.9 UART/RS-232 bus triggering

Press the key TYPE in the TRIGGER area of the front panel for setting the trigger conditions, then press the soft menu key SERIAL BUSES. Subsequently press the key SOURCE in the TRIGGER area and select the UART bus. (It will only be available if it was previously defined.) Then press the key FILTER in the TRIGGER area, all possible trigger options will be presented. Go to page 1 of the trigger menu for setting the trigger condition: STARTBIT, FRAME START, the N-th SYMBOL or a special date are offered. In order to enter a date, select the soft menu key DATA, a menu will open in which the desired settings can be performed.

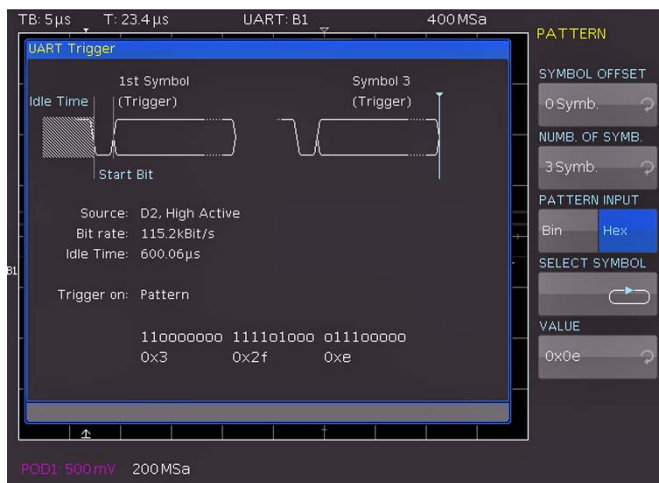

Fig. 13.12: UART data trigger menu

The soft menu key SYMBOL OFFSET and the universal knob are used to select a number of symbols from 0 to 4095 following the start bit which shall be ignored. The number of symbols to be used can be defined with the menu item NUMBER OF SYMBOLS as 1, 2 or 3. (The length of the symbols 5 to 9 bits was already set when defining the bus, it is automatically taken into account here). Select the menu item PATTERN INPUT for the entry of the values of the symbols which may again be in binary or hexadecimal format. If binary input is selected, the individual bits can be selected with the soft menu key SELECT

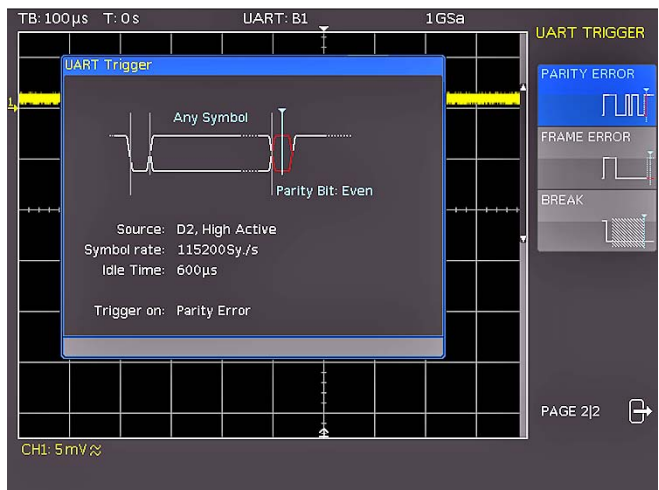

Fig. 13.13: Page 2 of the UART trigger menu.

BIT and the universal knob. With the soft menu key VALUE each bit can be set to 0,1 or X (don't care). If hexadecimal is selected, use the soft menu key VALUE and the universal knob to set the value of each symbol. The soft menu key SELECT SYMBOL is used to switch from symbol 1 to symbol 2 and to symbol 3 (if the number of symbols was set to 3.) The presently active byte will be identified in the display window by a green frame. Pressing the MENU OFF key twice will close all menus, and the oscilloscope will now trigger on the data set.

Use the respective soft menu key on page 2 of the UART trigger filter menu to select a PARITY ERROR, a FRAME ERROR or a BREAK as the desired trigger condition.

14 Remote control via interface

The HMO series is equipped with the interface card H0720, which have an RS-232 and USB connection on board as a standard.



To make any communication possible, the chosen interface and it's corresponding settings must be the same in the PC as in the oscilloscope. Only exception is the virtual COM port, which is described under the USB section.

14.1 RS-232

The RS-232 interface is made as a 9 pole D-SUB connector. Over this bi directional interface you can transfer settings, data and screen dumps from an external device (PC) to the oscilloscope or vice versa. The direct physical link between oscilloscope and serial port of the PC can be done via an 9 pole cable with shielding (1:1 wired). The maximal length must below 3 meter. The exact pinning of the plug is as follow:

Pin	Description
2	Tx Data (data from oscilloscope to external device)
3	Rx Data (data from external device to oscilloscope)
7	CTS ready for sending
8	RTS ready for receiving
5	ground (ground reference ,due to oscilloscope (category I)and power plug connected to earth)
9	+5 V supply voltage for external devices (max.400 mA)

The maxiaml amplitude at Tx, Rx, RTS und CTS is 12 Volt. The standard RS-232 settings are:
8-N-2 (8 data bits,no parityt, 2 stop bits),
RTS/CTS-Hardware-protocol: none.

In order to set these parameter at the HMO,please press the button SETUP at the front panel in the area GENERAL and hit the soft key INTERFACE at the opened soft menu. Make sure the RS-232 interface is chosen (blue backlighted) and then hit the button PARAMETER. This opens a menu where you can set and save all parameter for the RS-232 communication.

14.2 USB



All descriptions regarding the USB interface are true for the H0720 interface card as well as for the optional H0730 USB part. All currently available USB driver are fully tested, functional and released for Windows XP™ 32 Bit, Windows Vista™ or Windows 7™ both as 32Bit or 64Bit versions.

The USB interface must be chosen in the oscilloscope and does not need any setting. At the first connection Windows™ ask for a driver. The driver you can find on the delivered CD or in the internet at www.hameg.com at the download area for the H0720/H0730. The connection can be done via the normal USB or via the virtual COM port. The description how to install the driver you can find in the H0720/730 manual.



If the virtual COM port will be used, you must set USB as interface at the oscilloscope.

14.3 Ethernet (Option H0730)

The optional interface card H0730 does have a USB and Ethernet connection. The settings of the parameter at the oscilloscope are done after selecting ETHERNET as the interface and the soft key PARAMETER is chosen. You can set anything including a fix IP address. Alternative you can chose a dynamic IP setting via the DHCP function. Please ask your IT department for the correct setting at your network.

If the oscilloscope does have an IP Adress you can open your web browser and put this IP address into the adress line (<http://xxx.xxx.xxx.xx>). Since the H0730 does have a webserver integrated it will open a site with informations about the scope, the interface and it's setting.

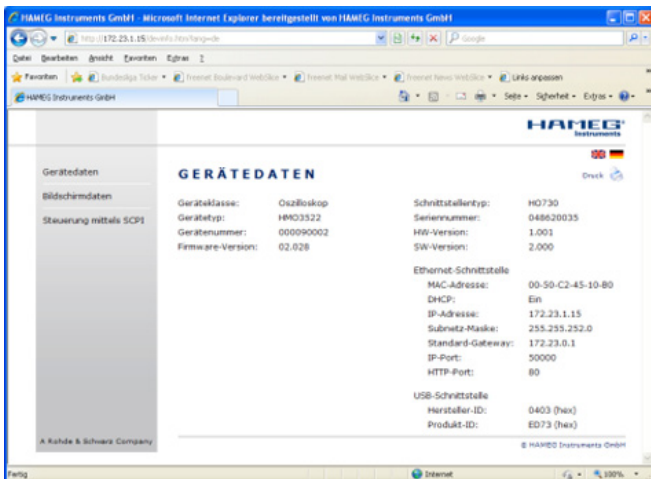

Fig. 14.1: web server with device data

On the left side there are links to „Screen Data“ which make it possible to transfer a screen dump to the PC. (Using the right mouse click this can be transferred to the clip board for further use. The link „SCPI Device Control“ open a site with a console to send remote SCPI commands to the oscilloscope.

14.4 IEEE 488.2 / GPIB (Option H0740)

The optional interface card H0740 does have a IEEE488.2 connection. The settings of the interface can be done in the oscilloscope after chose the IEEE488 as interface and hitting the soft key PARAMETER.

Further information you can find at the manual of the H0740 at the download area a tour homepage www.hameg.com.

15 Appendix

15.1 List of figures

Fig. 1.1:	Operating positions	6
Fig. 2.1:	Frontview of the HMO2024	8
Fig. 2.2:	Area A of the control panel.	8
Fig. 2.3:	Area B of the control panel.	9
Fig. 2.4:	Area C of the control panel	9
Fig. 2.5:	Area D of the control panel	9
Fig. 2.6:	Screen	9
Fig. 2.7:	Rear panel of the HMO2524	9
Fig. 2.8:	Selection of basic soft menu elements	10
Fig. 2.9:	Basic soft menu elements for settings and navigation	10
Fig. 2.10:	Menu for basic settings	10
Fig. 2.11:	Updating menu and information window	11
Fig. 2.12:	Updating menu and information window	12
Fig. 2.13:	„UPGRADE“ menu.	12
Fig. 2.14:	Manual licence key input.	12
Fig. 2.15:	Successful self alignment.	12
Fig. 3.1:	Control panel HMO	13
Fig. 3.1:	Control panel HMO	13
Fig. 3.2:	Screen display after connection of the probe	13
Fig. 3.3:	Screen display after changing to DC coupling	13
Fig. 3.4:	Screen display after Autosetup	13
Fig. 3.5:	Area of the control panel containing the ZOOM knob	13
Fig. 3.6:	ZOOM function	14
Fig. 3.7:	Cursor measurements	14
Fig. 3.8:	Quick View parameter measurement	14
Fig. 3.9:	Auto Measure menu	14
Fig. 3.10:	Selection of parameters	15
Fig. 3.11:	Measuring the parameters of two sources	15
Fig. 3.12:	Formula editor	15
Fig. 3.13:	Save/Recall menu	15
Fig. 3.14:	Menu SCREENSHOTS	16
Fig. 3.15:	Defining a file name	16
Fig. 4.1:	Front panel area with vertical system controls	16
Fig. 4.2:	Short menu for the vertical settings	16
Fig. 4.3:	Correct connection of the probe to the probe adjust output	17
Fig. 4.4:	Vertical offset in the extended menu	17
Fig. 4.5:	Threshold setting and name allocation	18
Fig. 5.1:	Control panel of the horizontal system	18
Fig. 5.2:	Zoom function	19
Fig. 5.3:	Marker in zoom mode	20
Fig. 6.1:	Front panel control area of the trigger system	20
Fig. 6.2:	Coupling modes with slope trigger	20
Fig. 6.3:	The type B-Trigger	21
Fig. 6.4:	Pulse trigger menu	21
Fig. 6.5:	Video trigger menu	22
Fig. 7.1:	Drawing of the virtual screen area and an example	23
Fig. 7.2:	Menu for setting the signal display intensities	23
Fig. 7.3:	Persistence function	23
Fig. 7.4:	Settings in the X-Y menu	23
Fig. 7.5:	Settings for the Z input	24
Fig. 8.1:	Cursor measurements selection menu	24
Fig. 8.2:	Menu for the automatic measurements settings	25
Fig. 9.1:	Mathematics short menu	27
Fig. 9.2:	Quick mathematics menu	27
Fig. 9.3:	Formula editor for a set of formulas	27
Fig. 9.4:	Entering constants and units	28
Fig. 9.5:	FFT presentation	28
Fig. 9.6:	Extended FFT menu	29
Fig. 9.7:	PASS/FAIL mask test.	30
Fig. 10.1:	Basic menu for instrument settings	30
Fig. 10.2:	Storing instrument settings	30
Fig. 10.3:	Recalling instrument settings	31
Fig. 10.4:	Import/Export menu for instrument settings	31
Fig. 10.5:	Loading and storing of references	31
Fig. 10.6:	Menu for storing curves	32
Fig. 10.7:	Menu for screen shots	32
Fig. 10.8:	Definition of FILE/PRINT key	33
Fig. 11.1:	Component tester at short	34
Fig. 12.1:	Logic trigger menu	35
Fig. 12.2:	Logic channels' settings display	36
Fig. 13.1:	Bus definition menu	37
Fig. 13.2:	Menu for the selection of the decoding format	37
Fig. 13.3:	Menu for the definition of the I ² C sources.	37
Fig. 13.4:	I ² C message, hexadecimal decoded.	38
Fig. 13.5:	I ² C READ/WRITE trigger menu	38
Fig. 13.6:	I ² C data Trigger menu	38
Fig. 13.7:	Menu for the SPI bus definition	39
Fig. 13.8:	SPI trigger menu	39
Fig. 13.9:	SPI data trigger menu.	39
Fig. 13.10:	Page 1 of the UART bus definition menu.	40
Fig. 13.11:	Page 2 of the UART bus definition menu	40
Fig. 13.12:	UART data trigger menu	40
Fig. 13.13:	Page 2 of the UART trigger menu.	40
Fig. 14.1:	web server with device data	42

15.2 Glossary

A

acquisition mode: 9
 addition: 9, 14, 15, 18, 23, 27, 31, 38, 39
 ADJ. output: 13
 adjustment: 8, 9, 17, 18
 amplitude: 23, 24, 25, 26, 29
 analog channel: 17, 35
 analysis functions: 27
 Analyze: 8
 apparent impedance: 33
 arbitrary: 18
 arrow buttons: 20
 Auto: 14, 20, 25
 AUTOMATIC: 11, 19, 23
 AUTOMEASURE: 14, 25
 AUTOSET: 9, 13, 14
 average: 7, 19

B

bandwidth: 10, 16, 19
 Base Level.: 26
 bipolar: 34
 Blackman: 29
 BNC connector: 9, 13

brightness: 23
 B-Trigger: 20, 21
 bus: 11, 36, 37, 38, 39, 40
 bus analysis: 11, 37, 38, 39, 40
 Bus Signal Source: 11

C

capacitance: 33
 capacitor: 33
 capturing modes: 18
 component tester: 8, 9, 33, 34
 COM port: 41
 constants: 28
 COUNT -: 26
 COUNT +: 26
 COUNT-/ : 26
 COUNT::: 25
 coupling: 13, 16, 17, 21
 cursor measurements: 14, 24, 25, 36
 Cursor/Menu: 8, 19
 CURSOR SELECT: 14, 21
 curves: 9, 23, 30, 31, 32, 33

D

data manager: 12, 30, 31, 32
 digital channel: 35
 divisions: 9, 18, 22, 23, 27, 29
 DVI connector: 9

E

envelope: 19, 29
 equations: 27, 28
 Ethernet: 9, 42

F

factory settings: 30
 FALL TIME: 26
 FFT analysis: 28
 FFT display: 28, 29
 FFT function: 29
 FFT results: 29
 FILE/PRINT: 9, 16, 33
 firmware: 11, 12, 35
 formula editor: 15, 27
 frequency: 11, 14, 17, 21, 23, 24, 26, 27, 28, 29, 36
 frequency analysis: 27, 28

G

General: 8, 10, 12
 glue to: 25

H

half frames: 22
 Hamming: 29
 Hanning: 29
 hardware counter: 24, 26
 help: 10, 11, 12
 high pass filter: 21
 Horizontal: 9, 18
 horizontal positioning: 14
 Horizontalsystem: 19, 20

I

IEEE-488: 9
 inductance: 33
 input impedance: 16
 instrument settings: 8, 11, 15, 30, 31
 intensity: 23, 24

L

language: 9, 10, 12
 level: 9, 10, 16, 21, 22, 24, 25, 26, 35, 37
 licence key: 12, 37
 LINE MIN: 22
 logic channel: 35, 36, 37, 40
 logic level: 35, 37
 logic probes: 8, 9, 35
 low pass filter: 21

M

mains safety earth: 33
 mathematics function: 9
 MAX. REP RATE: 19
 MAX. SAMPL. RATE: 19
 mean value: 15, 25, 26, 29
 mean voltage: 14, 26
 memory depth: 13, 19
 memory location: 28
 mixed-signal operation: 10
 Modulation: 24
 multiplication: 27

N

Negative Duty Cycle:: 26
 NIBBLE: 39
 Normal: 18, 19, 20
 normal trigger: 9, 18
 NOT-ACKNOWLEDGE: 38
 NTSC: 22

O

offset: 17, 22, 38, 39
 open-circuited: 33

P

PAL: 22
 PASS/FAIL: 29, 30
 PATTERN INPUT: 39, 40
 PEAK -: 26
 PEAK +: 26
 PEAK LEVELS: 25
 peak-to-peak voltage: 14
 PEAK VALUE: 19
 peak voltage: 14, 29
 PERIOD: 26
 Persistence: 8, 23
 phase shift: 33
 polarity: 20, 22, 34
 Positive Duty Cycle:: 26
 Probe attenuation: 17
 pulse trigger: 21, 35
 Pulse Width -: 26
 Pulse Width +: 26

Q

quickview: 10, 14
 Quickview mode: 29

R

RANDOM SAMPL: 19
 RATIO X: 24, 36
 RATIO Y: 25
 reference: 8, 9, 10, 18, 21, 30, 31, 32, 35, 37
 reference curves: 30, 31
 reference signal: 8, 9
 resistive loss: 33
 rise and fall times: 14, 25
 Rise-time: 15, 25, 26, 29

RMS MEAN: 25
rms value: 14, 25, 29
Roll: 18
RS-232 interface: 41

S

sampling rate: 9, 19
Save/Recall: 8, 15
SCL: 11
SCPI Device Control: 42
screen displays: 8, 15, 30
Screenshots: 15, 16, 32
SDA: 11
self alignment: 12, 43
semiconductors: 34
sensitivity: 16, 17
short menu: 9, 13, 15, 16, 17, 27, 31, 35, 36, 37
Signal inversion: 17
Signals: 15
signal source: 11, 13, 16
single sweep: 9
Single: 20
slope: 9, 20, 21, 26, 36, 39
soft key: 8, 10, 11, 12, 13, 14, 15, 16, 17, 19, 21, 22, 25, 32, 35
soft menu keys: 10, 21, 23, 25, 27, 36
sources: 14, 15, 21, 22, 24, 25, 27, 37
Square: 11, 27, 29
square wave signal: 11, 13
storage location: 30
subtraction: 15, 27

T

test object: 33
TIME: 10, 11, 19, 21, 24, 26, 29, 35, 36, 40
time base: 9, 11, 13, 14, 18, 19, 23, 28, 29, 30, 31
toggle key: 29, 30, 37
Top Level:: 26
trigger conditions: 9, 18, 20, 30, 38, 39, 40
TRIGGER FREQ: 26
trigger level: 9, 21, 22, 26, 35
trigger mode: 20, 21
TRIGGER PER.: 26
trigger signal: 9, 21, 26
trigger slope: 9
trigger source: 9, 20, 26, 35
Triggersystem: 21, 22
trigger type: 9, 20, 21, 38
two-window display: 14

U

UART: 11, 12, 37, 39, 40, 41
UART/RS-232 Bus: 39, 40
universal knob: 10, 12, 15, 16, 19, 21, 22, 23, 24, 25, 27, 28, 29, 31, 32, 35, 36, 38, 39, 40, 41
UPGRADE menu: 12
USB port: 8, 11, 12, 32
USB stick: 8, 11, 15, 16, 28, 30, 31, 32
user interface: 10

V

VERTICAL: 9, 17, 23, 24, 31, 35, 36, 37
vertical amplifier: 17
vertical position: 16
V-marker: 14
V MARKER: 25, 36
voltage: 7, 14, 16, 17, 24, 25, 26, 29
voltage selector: 7

X

XY function: 23, 24
XY mode: 9

Y

Y-Positioning: 17

Z

Z input: 24
ZOOM: 13, 14, 19, 20

Oscilloscopes

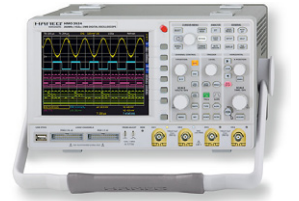

Spectrum Analyzer



Power Supplies



Modular System
Series 8000



Programmable Instruments
Series 8100



41-HMOF-7XE0

authorized dealer

www.hameg.com