



2015/2016

Electronics housings

Electronics housings for industrial, building and field applications

Complete flexibility in terms of shape, color, and function – this is the central idea behind electronics housings from Phoenix Contact. Whether on the wall, as handheld housing or on the DIN rail, from light gray to sky blue, narrow or wide – you will always find the right housing with the appropriate connection technology for your electronics.

Building installation housings

- Housing design in accordance with DIN 43880 for distributor boards
- High-position DIN rail connector for contacting individual devices
- Simple integration of different connection technology from Phoenix Contact



Field housings

- Protect your electronics from dust and splash water
- Universal or permanently integrated connection technology
- Comprehensive accessory range, including individual membrane keypads
- Customer-specific housing modifications in terms of shape and color





Electronics housings for industrial use

- Comprehensive standard housing range for DIN rail mounting
- Universal or permanently integrated connection technology
- Comprehensive selection of individual adaptations to the electronics housing in terms of shape, color and geometry



Contents

Basic housings

EH series Pages 4 – 5

Modular housings

ME series Pages 6 – 7

ME-MAX series Pages 8 – 9

Multifunctional housings

ME-IO series Pages 10 – 11

ME-PLC series Pages 12 – 13

Building installation housings

BC series Pages 14 – 15

Press-drawn section housings

UM-BASIC series

UM-PRO series Pages 16 – 17

UM-ALU series Pages 18 – 19

Field housings

HC-ALU series Pages 20 – 21

Product and configuration overview

Pages 22 – 57

Customer-specific electronics housings

Pages 58 – 59

Find out more with the web code

You can find web codes in this brochure: a pound sign followed by a four-digit number combination.

i Web code: #1234 (example)

This allows you to reach information on our website quickly.

It couldn't be simpler:

1. Go to the Phoenix Contact website
2. Enter # and the number combination in the search field
3. Receive more information and product versions

Or use the direct link:

[phoenixcontact.net/webcode/#1234](https://www.phoenixcontact.net/webcode/#1234)

EH basic housings for universal applications

The EH housing system makes it quite easy to design universal device applications. A range of 7 overall widths, 2 overall heights and 3 cover versions provide over 100 possible combinations.

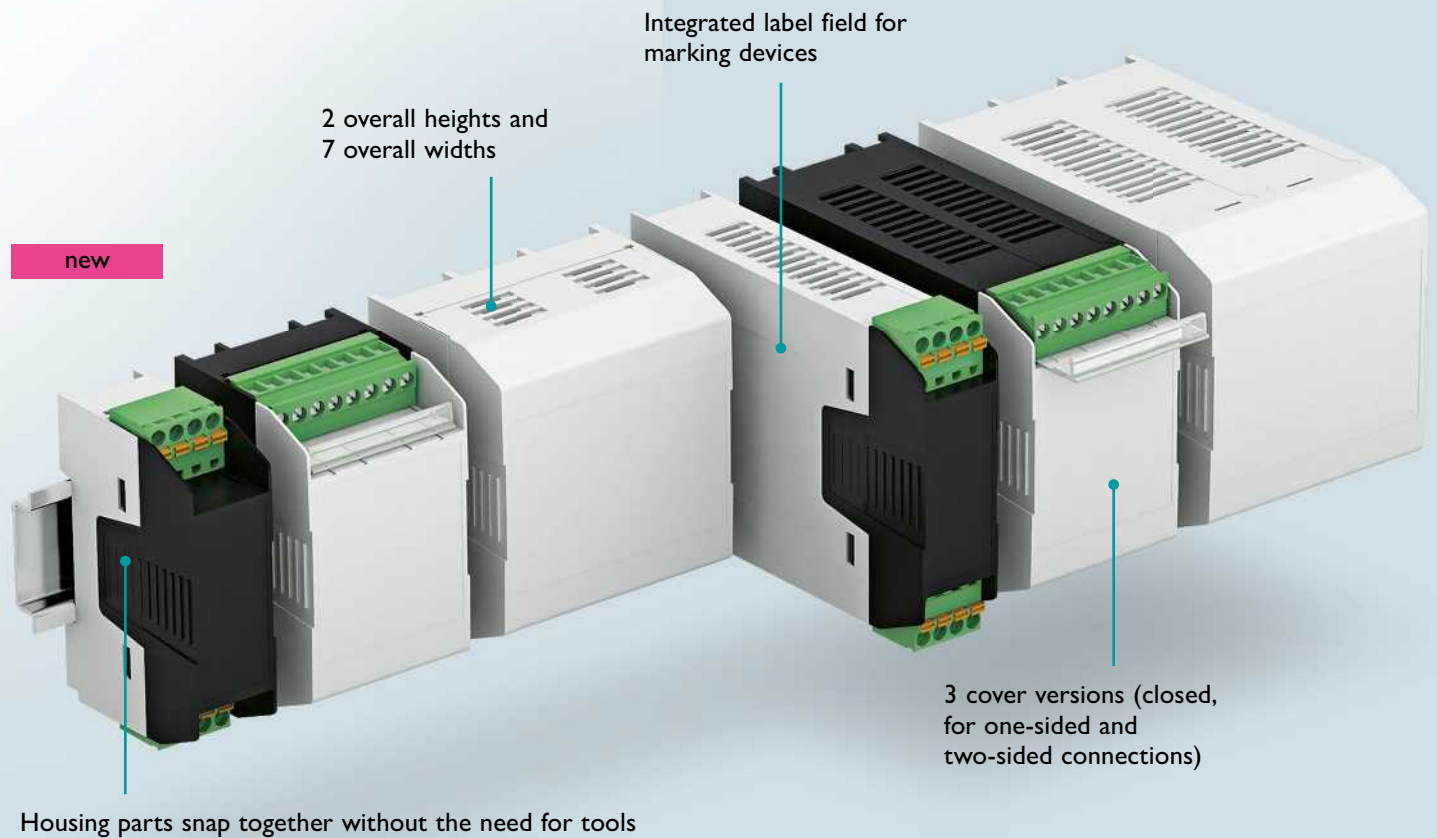
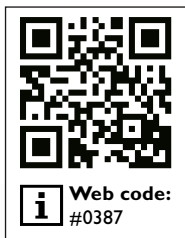

With industrial electronics, it is particularly important that the device's design is suited to its applications. Thanks to various housing designs and professional connection technology, the EH housing series offers a highly functional overall solution.



Advantages at a glance



PCBs can be installed in all three spatial directions



DIN rail or wall mounting for device fastening suited to the applications



Cover versions for different PCB connection technology

Modular ME housings in an easy-to-install cup shape

The ME electronics housings transform assembled PCBs into easy-to-install electronics modules.

Variable connection technology, bus connectors, and modularity ensure the right device design for every application.

Diverse adaptation options expand the range of individual housing solutions.

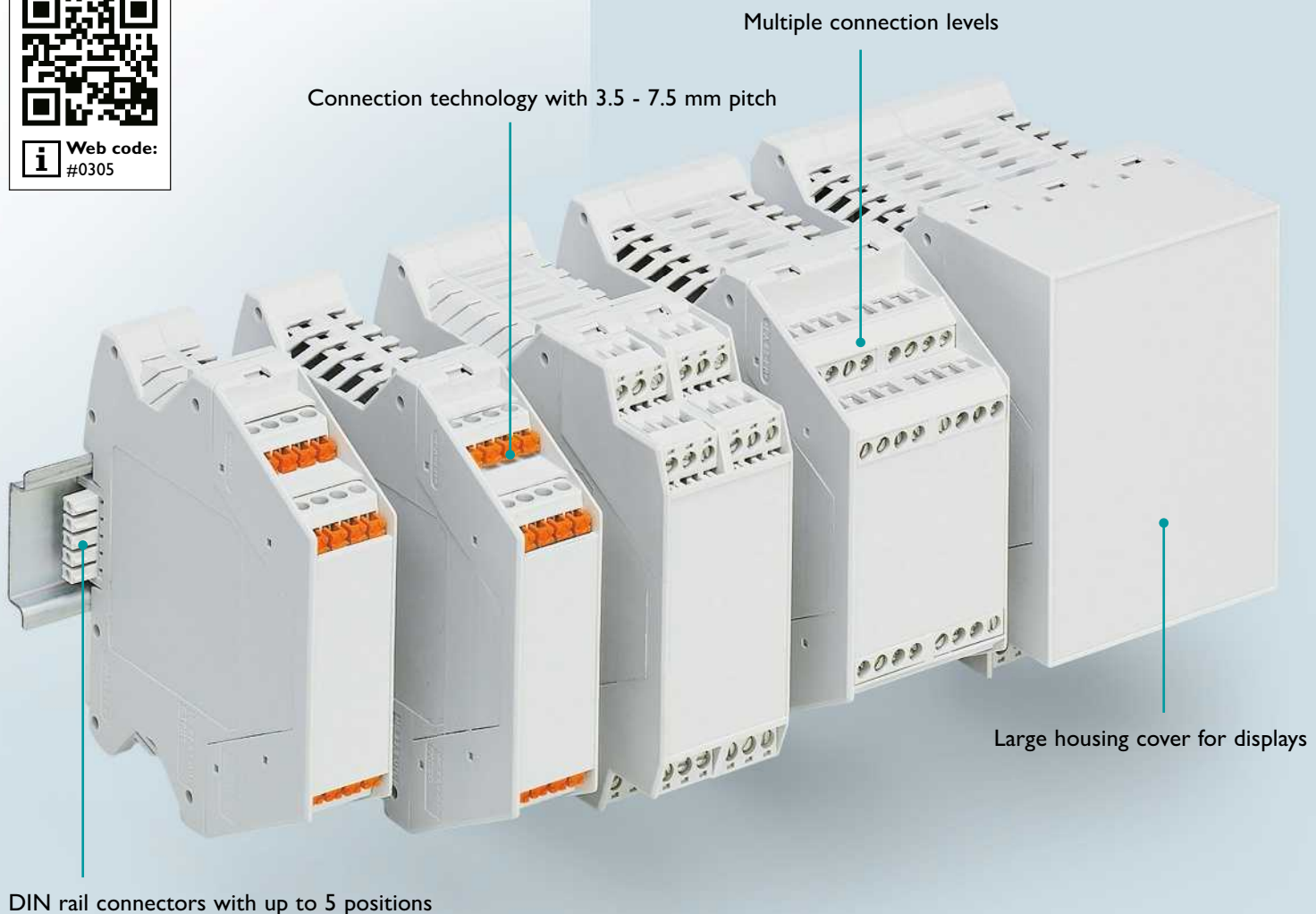
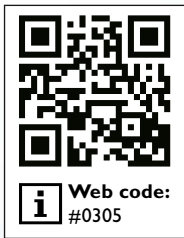

DIN rail connectors with up to 5 positions

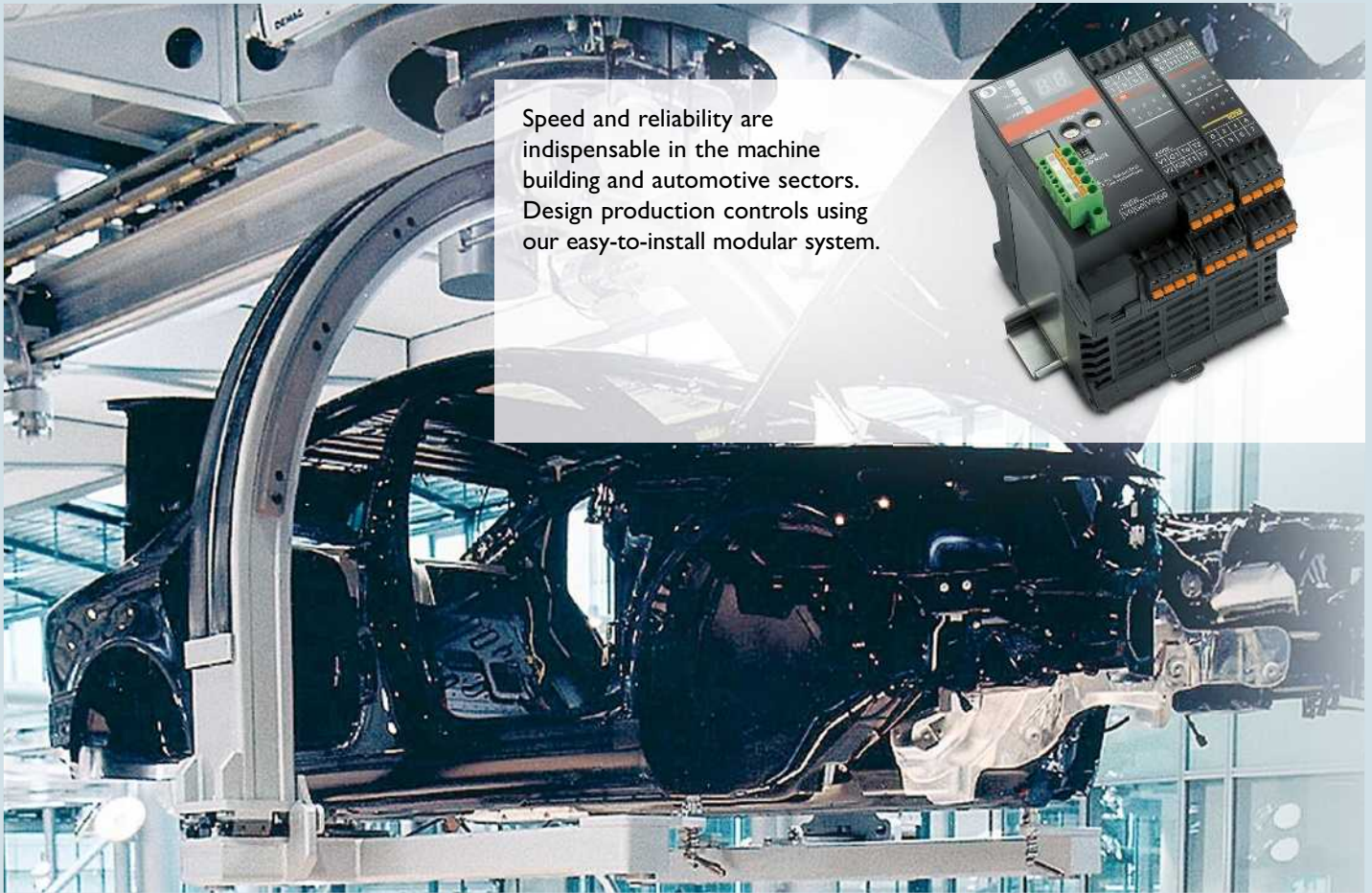

Speed and reliability are indispensable in the machine building and automotive sectors. Design production controls using our easy-to-install modular system.

Advantages at a glance

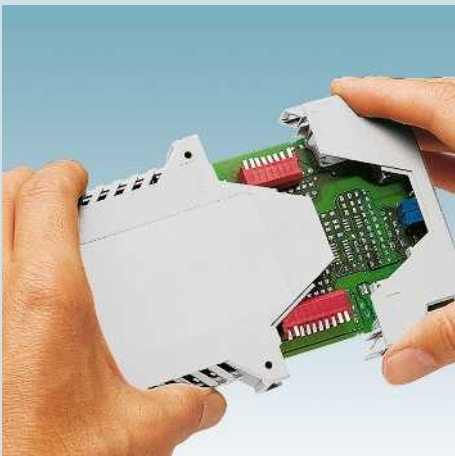

Cup principle for short assembly times



Easy opening for servicing and maintenance

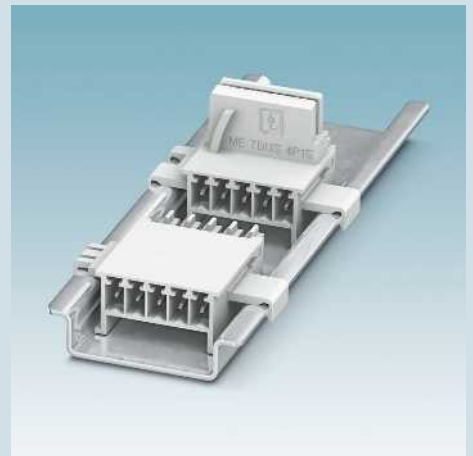

DIN rail connector for reliable module contacting

ME-MAX modular housings in flexible modular design

The modular ME-MAX electronics housings provide functional, design-oriented packaging for modern industrial electronics. Variable connection technology, bus connectors and modularity ensure the right device design for every application.

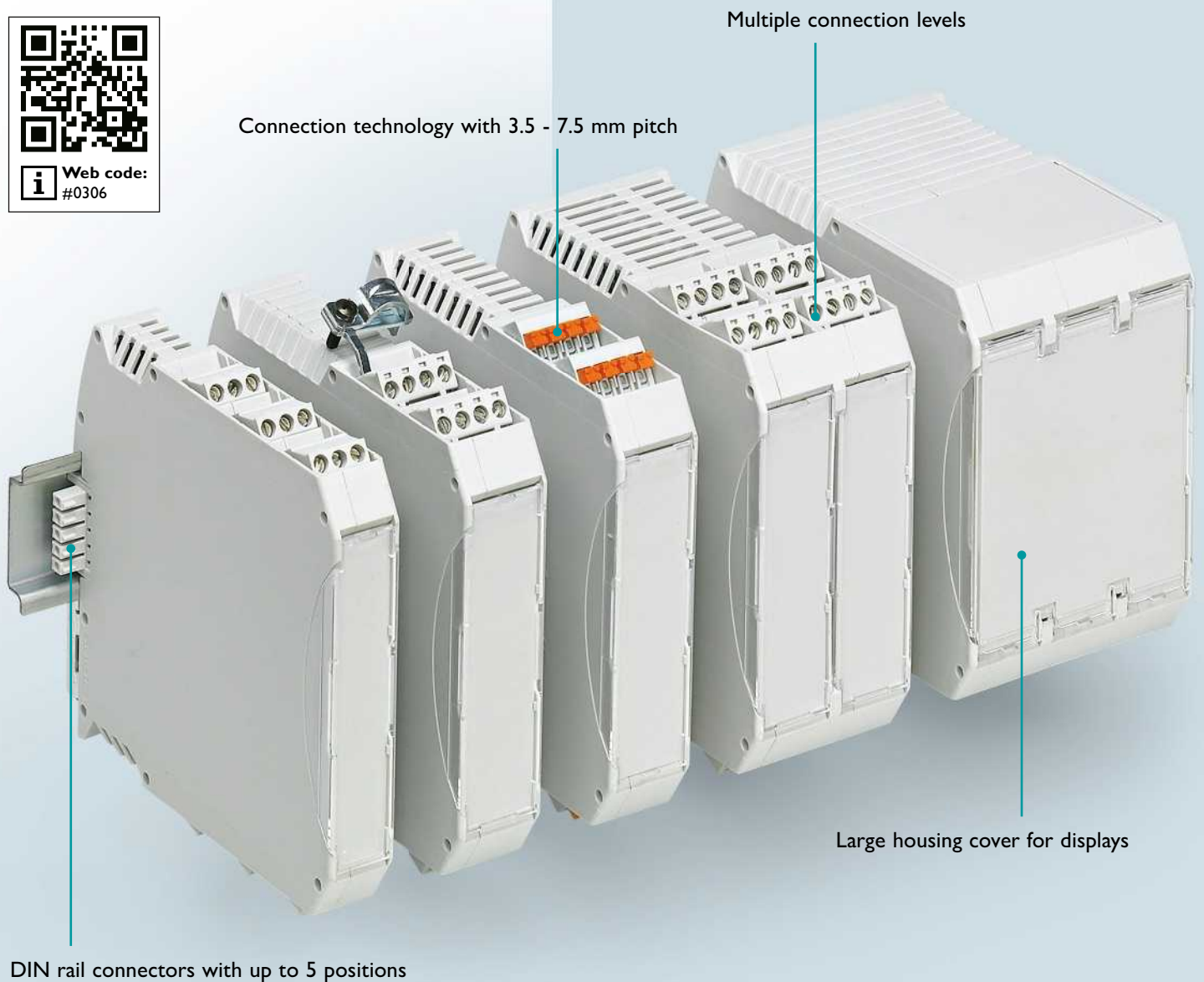
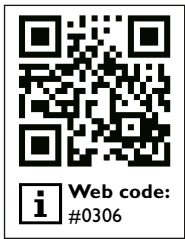

The variable housing shape factor and compatibility of connection technology make it ideal for creating remote control stations for energy networks, for example.



Advantages at a glance



Modular housing design for variable geometries



Connection technology for signal, data and power transmission



Power connectors for simple module contacting

ME-IO multifunctional housings with modular front connection technology

The ME-IO housing system is ideal for applications involving a cramped installation space. Its push-in front connection technology and compact design allow for the implementation of small devices with up to 36 positions.

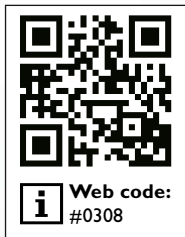

Width: 18.8 mm

Up to 36 connection positions



DIN rail connectors with up to 5 positions

Lock and Release system

Push-in connection

There is limited space for controller and I/O systems that are used with packing and assembly machines. In spite of this, comprehensive functions must be implemented using a variety of signal inputs and outputs. ME-IO is the optimum implementation solution for this requirement.



Advantages at a glance

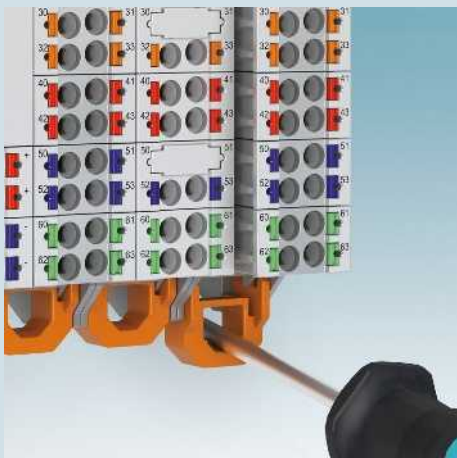

Easy installation and removal thanks to the Lock and Release system



Avoiding incorrect connection through plug coding



Convenient connection of modules through DIN rail connectors

ME-PLC multifunctional housings for complex controllers

The ME-PLC housing system is ideal for applications that require large installation spaces and front-side connection technology. When combined with a large PCB assembly surface and DIN rail connectors, this housing system offers a high level of functionality for a wide range of applications.

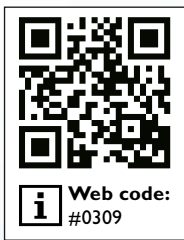

105 mm

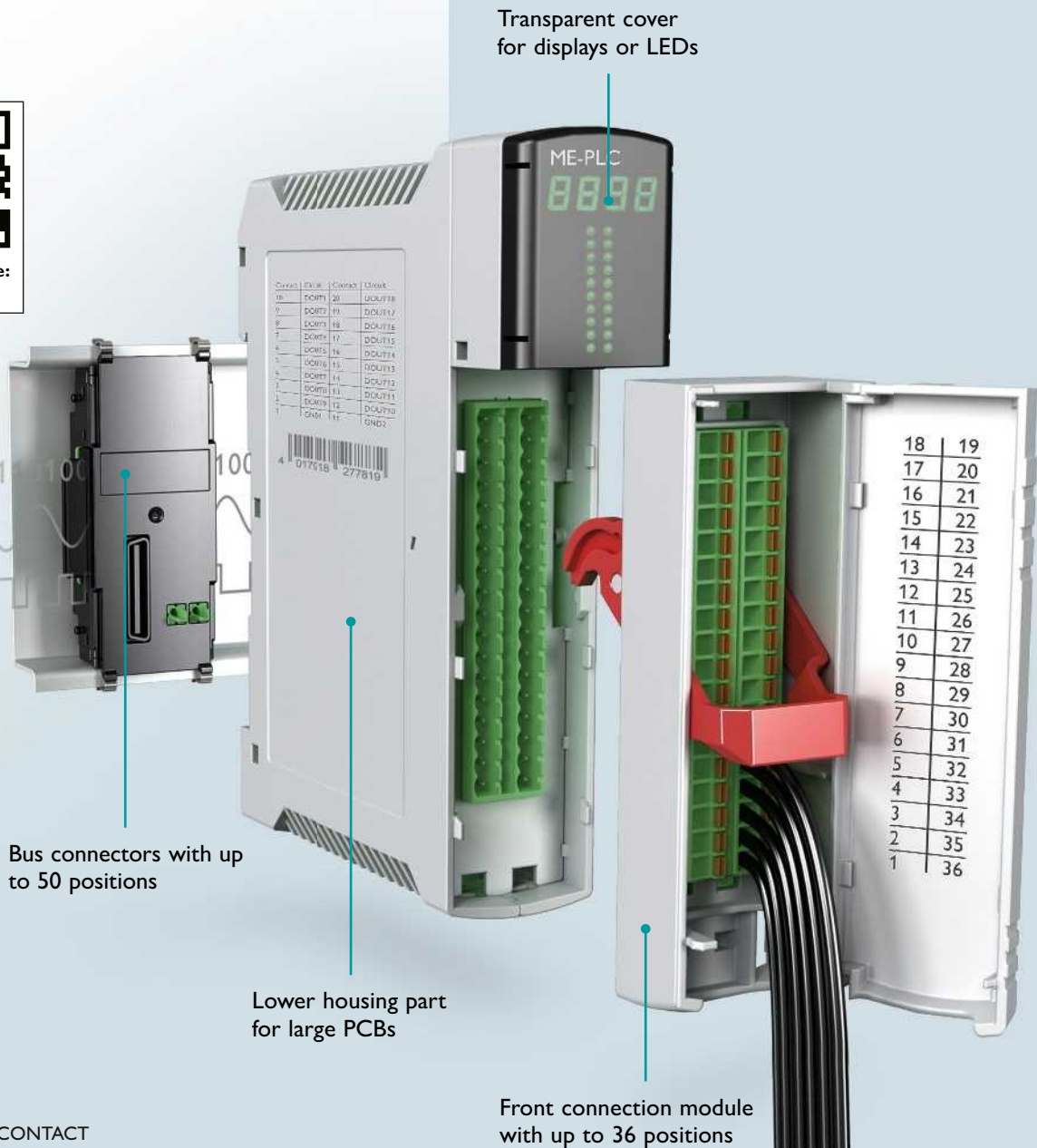



Full flexibility, lots of space for electronics and convenient connection options are ideal conditions for use in process technology.



Advantages at a glance



Easy insertion and removal thanks to lever technology



DIN rail connectors for power and data communication



Universal cover design for freely selectable connection technology

Modular BC building installation housings

The BC housing system represents future-oriented applications in building automation.

It can be used in any distributor board thanks to the internationally established DIN 43880 standard. In addition to a modern design, this housing series also features many connection technologies and a high-position DIN rail connector.

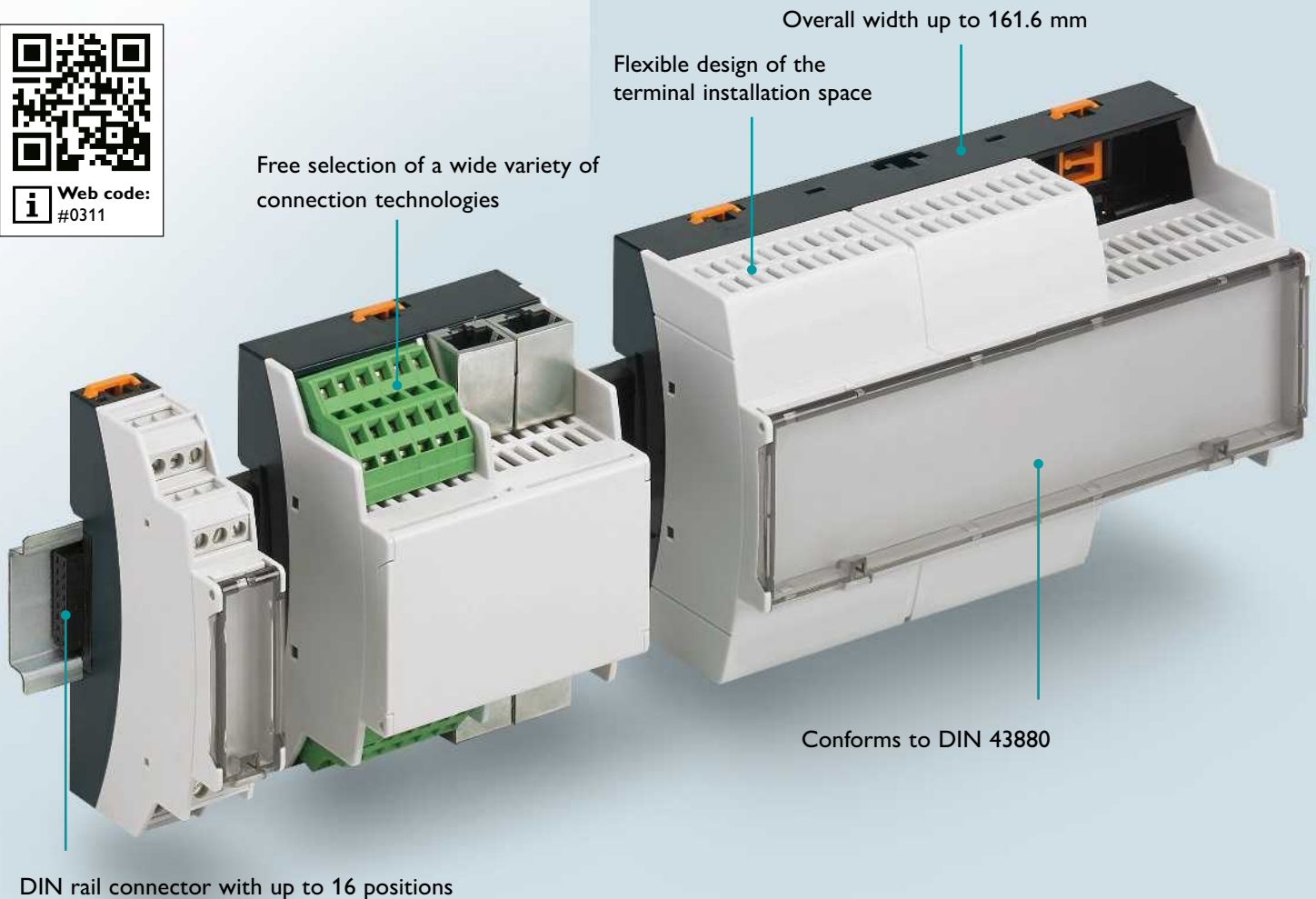
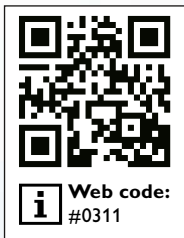



Advantages at a glance



Designed in accordance with DIN 43880 for distributor boards

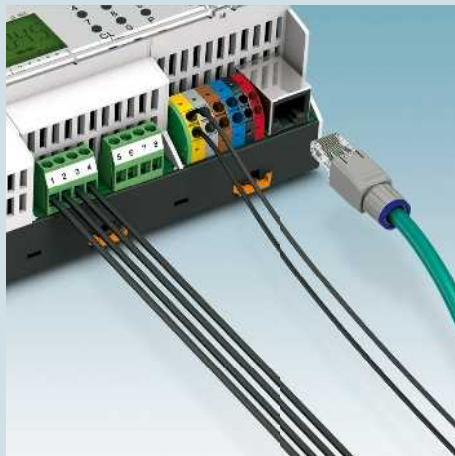

Free choice of connection technology

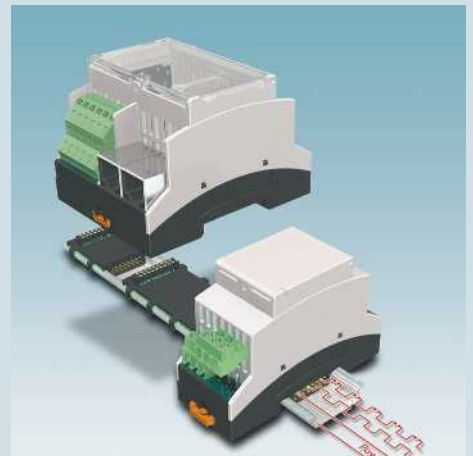

Connection of one device to the next in the DIN rail

Flexible UM press-drawn section housings for customized PCB sizes

In modern and functional industrial electronics, large-scale components are often installed.

With fast mounting and availability in all dimensions, flexible housing systems such as the UM-BASIC and UM-PRO series have been designed especially with these applications in mind.

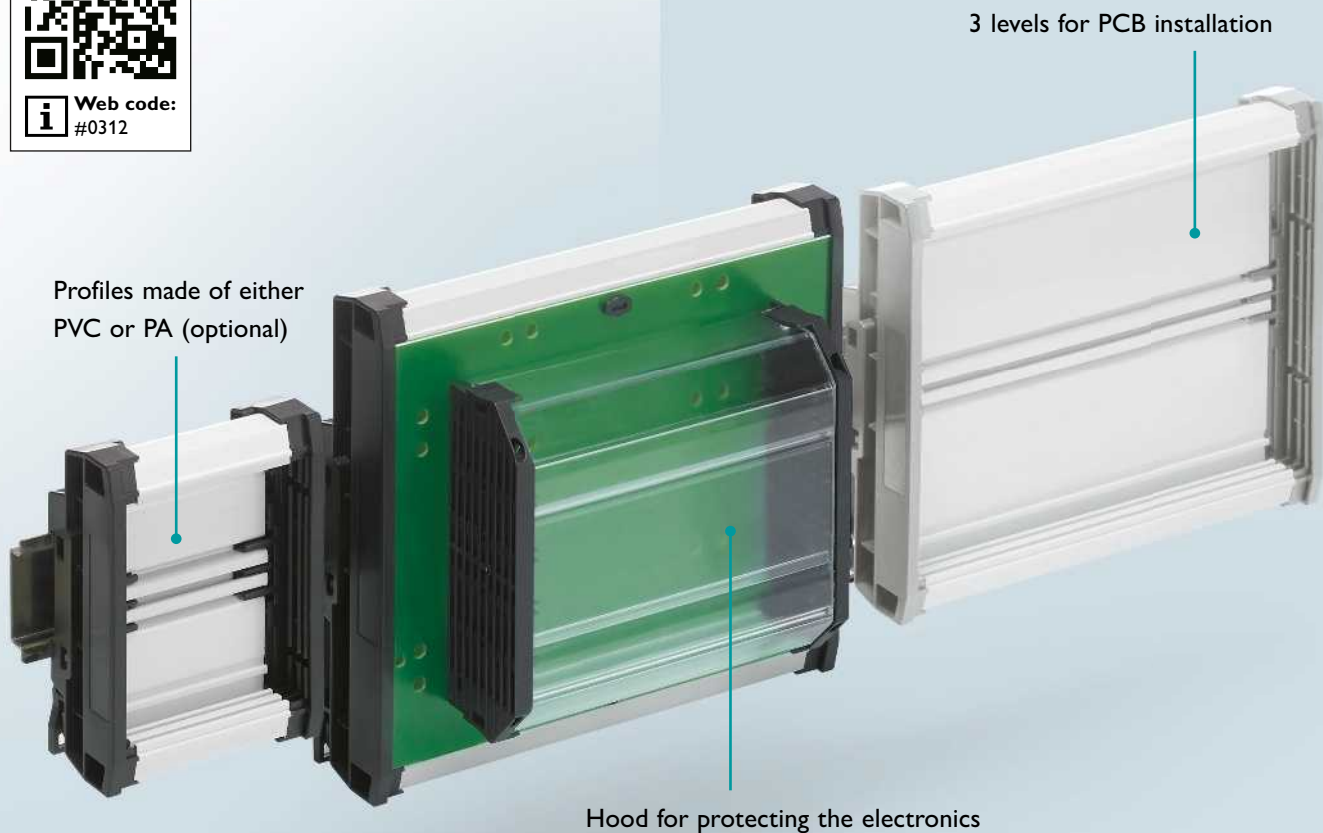
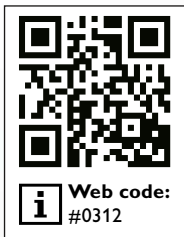

Industrial electronics such as I/O boards often rely on flexibility, a functional design and quick assembly. The selection of suitable materials - which depends on the temperature requirements - is also critical.

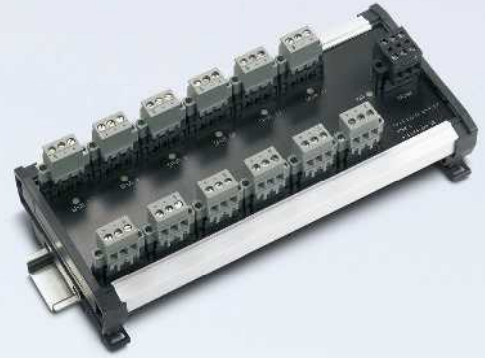

Advantages at a glance



Two material versions for different temperature ranges: UM-BASIC 50 °C, UM-PRO up to 100 °C

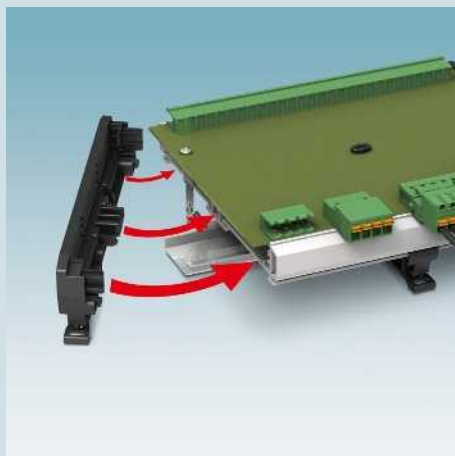

Tool-free device assembly using the snap-mount principle



High degree of flexibility thanks to freely positionable covering hoods

Flexible UM-ALU press-drawn section housings for EMC-sensitive electronics

In industrial areas with a high electromagnetic interference potential, the requirements for EMC-sensitive electronics are stringent.

The UM-ALU housing system is made entirely of aluminum, offers excellent EMC protection and guarantees full flexibility in the assembly process.

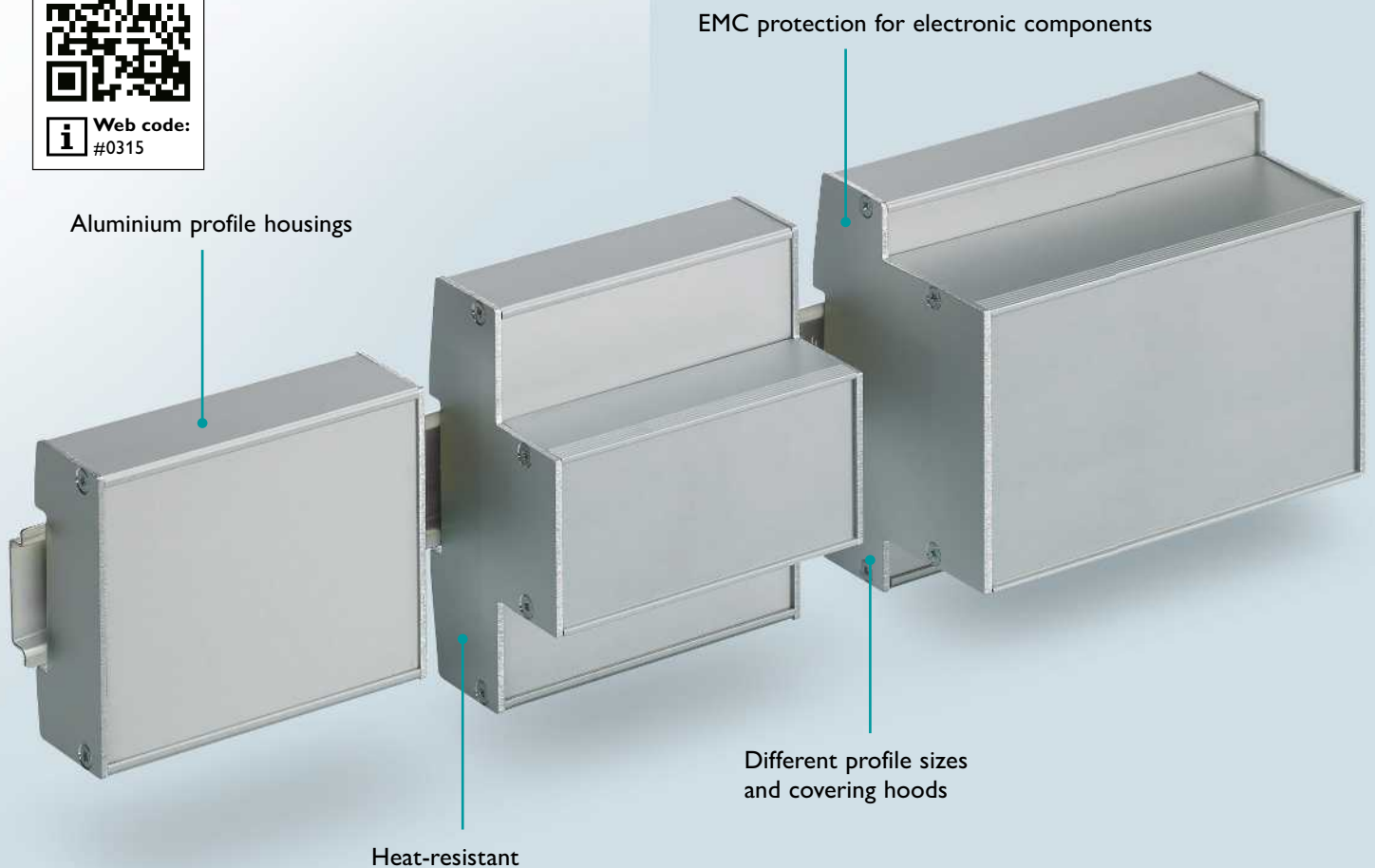
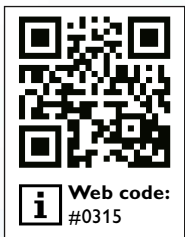



Advantages at a glance



Made entirely of aluminum – EMC-protected and heat-resistant

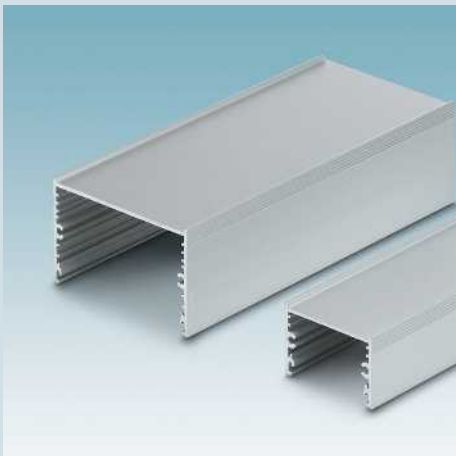

Various covering hoods ensure optimum shock protection

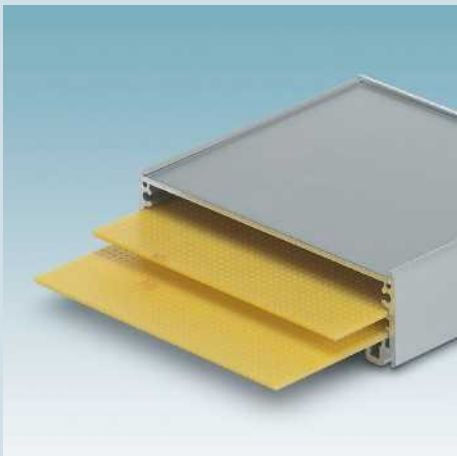



Flexible installation levels enable correct device development for your applications

Rugged HC-ALU field housings for mobile applications

HC-ALU aluminum handheld housings protect electronics from splash water, as well as thermal and mechanical influences in the field.

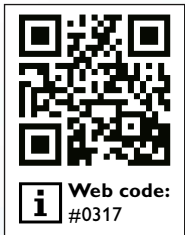
The housings are ideal for temperature ranges from $-40\text{ }^{\circ}\text{C}$ to $+70\text{ }^{\circ}\text{C}$ and provide IP65 splash water protection in accordance with DIN EN 60529.





Mobile handheld devices or electronics modules are often used in harsh environments. Protect your electronics for continuous outdoor use with HC-ALU series housings.



Advantages at a glance



Divided profile for easy module integration

















Individual modifications such as membrane keypads or display

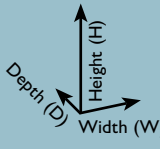

Wall fastening for stationary applications

Technical data of the electronics housings

		Universal basic housings	Modular housings		Multifunctional housings	
		new				
		 Web code: #0387	 Web code: #0305	 Web code: #0306	 Web code: #0308	
Housing series		EH	ME	ME-MAX	ME-IO	
Mounting	On DIN rail DIN EN 60715	TS35	TS35	TS35	TS35	
	Other	Wall mounting, direct fastening				
Temperature range	[°C]	-40° ... +80°	-40° ... +105°	-40° ... +105°	-40° ... +105°	
Degree of protection	in accordance with DIN EN 60529	IP20	IP20	IP20	IP20	
Dimensions		Width [mm]	22.5/35/45/52.5/67.5 70/90	12.5/17.5/22.5 35/45/67.5/90	6.2/12.5/17.5/22.5 35/45/67.5/90	18.8
		Depth [mm]	50/110	92/106/114.5	70.4/92/114.5	77
		Height [mm]	75.4	99	99	113
PCB surface	Max. usable surface [mm ²]	5,600 to 7,200	2,000 ... 6,600	3,400 ... 8,500	3,370 ... 5,280	
Power dissipation	Max. dissipated power [W] in direct apposition	4.4 ... 10.4	5.2 ... 10.4	5.2 ... 8.2	2.8	
PCB connection	Max. number of positions for 3.5 mm pitch	5 ... 21	5 ... 40	18 ... 120		
	Max. number of positions for 5.0 mm pitch	4 ... 17	4 ... 32	8 ... 96	36	
	Max. number of positions for 7.25 mm and 7.5 mm pitches		3 ... 24	12 ... 72		
Bus connector	Type		DIN rail connector ¹⁾ Integrated cross connection ²⁾	DIN rail connector ³⁾ Power bus connector (PCO) ⁴⁾	DIN rail connector	
	Type		ME 6,2 TBUS ¹⁾ ME 17,5 TBUS ¹⁾ ME 22,5 TBUS ¹⁾	ME 6,2 TBUS ³⁾ ME 17,5 TBUS ³⁾ ME 22,5 TBUS ³⁾ PBR ⁴⁾	ME 18,8 TBUS	
	Number of positions		5 ¹⁾ 5 ²⁾ 10 ²⁾	5 ³⁾ 2 ⁴⁾	5	
	Current carrying capacity (depends on the derating)			max. 5 x 8 A, 125 V DC ¹⁾ max. 5 x 8 A, 125 V DC ²⁾	max. 5 x 8 A, 125 V DC ³⁾ 42 A, 60 V DC ⁴⁾	max. 5 x 8 A, 125 V
Material	Designation	ABS	PA (polyamide)	PA (polyamide)	PA (polyamide)	
	Flammability rating	HB (UL94)	V0 (UL94)	V0 (UL94)	V0 (UL94)	

Buildings	Building installation housings	Press-drawn section housings			Field housings
					
i Web code: #0309	i Web code: #0311	i Web code: #0313	i Web code: #0314	i Web code: #0315	i Web code: #0317
ME-PLC	BC	UM-BASIC	UM-PRO	UM-ALU	HC-ALU
TS105 or 2x TS35	TS35	TS35	TS35	TS35	
	Wall mounting, direct fastening	Wall mounting, direct fastening	Wall mounting, direct fastening		Handheld Wall mounting, direct fastening
-40° ... +125°	-40° ... +125°	-15° ... +50°	-40° ... +100°	-40° ... +105°	-40° ... +70°
IP20	IP20			IP20	IP65
40	17.8 (1 div.) Up to 161.6 (9 div.)	Freely selectable profile length 30 ... 1,000	Freely selectable profile length 30 ... 1,000	Profile lengths 42.5/60/95/130/165/200 235/990	Profile length 100/150/200/1000
159	62.2	40	40	33	33
180	89.7	92.3 to 142.3 72/108/122 Internal dim. of the PCB holder	92.3 to 142.3 72/108/122 Internal dim. of the PCB holder	72/100.5	53.5/78/100.5/161
15,000	2,200 ... 13,000	700/cm	1,200/cm	3,000 ... 97,000/cm	5,000 ... 158,000
Approx. 25	2.95 ... 16.95				
Optional configuration	Optional configuration	Optional configuration	Optional configuration	Optional configuration	Optional configuration
Optional configuration	Optional configuration	Optional configuration	Optional configuration	Optional configuration	Optional configuration
Optional configuration	Optional configuration	Optional configuration	Optional configuration	Optional configuration	Optional configuration
DIN rail connector (only with TS105)	DIN rail connector	Integrated cross connection	Integrated cross connection		
ME PLC 40 BUS 10 ⁵⁾ ME PLC 40 BUS 50 ⁶⁾	HBUS	Optional configuration	Optional configuration		
10 ⁵⁾ 50 ⁶⁾	16	Optional configuration	Optional configuration		
8 A, 160 V ⁵⁾ 1 A, 30 V ⁶⁾	max. 3 A/pos., 60 V DC	Optional configuration	Optional configuration		
PC (polycarbonate)	PC (polycarbonate)	PVC	Reinforced PA (polyamide)	Anodized aluminum	Anodized aluminum
V0 (UL94)	V0 (UL94)	V0 (UL94)	V0 (UL94)		

(1) All information pertains to the DIN rail connector (TBUS).
(2) All information pertains to the integrated cross connection.

(3) TBUS DIN rail connector.
(4) PBR power connector with PCO connection technology.









(5) ME-PLC-BUS 10-pos. DIN rail connector.
(6) ME-PLC-BUS 5-pos. DIN rail connector.

Configuration overview

ME MAX series

new

i Web code: #0387

1 Lower housing part				2 Upper housing part			3
Lower housing part Design	Color	Housing width	Order No.	One side open	Both sides open	Both sides closed	
Tall design 	Light gray (similar to RAL 7035)	22.5 mm	2201248				4-pos., green 5-pos., light gray
		35 mm	2201738	2201744	2201750	2200241	5-pos., light gray (2 units required) 6-pos., green
		45 mm	2201483	2201509	2201512	2201513	8-pos., green 5-pos., light gray
		52.5 mm	2201741	2201747	2201753	2200324	9-pos., green
		67.5 mm	2201485	2201515	2201518	2201520	12-pos., green
		70 mm	2201742	2201748	2201754	2200397	13-pos., green
		90 mm	2201487	2201523	2201525	2201526	17-pos., green
Tall design 	Black (similar to RAL9005)	22.5 mm	2201249				4-pos., green 5-pos., black
		35 mm	2201739	2201745	2201751	2200253	6-pos., green 5-pos., black (2 units required)
		45 mm	2201484	2201510	2201511	2201514	8-pos., green 5-pos., black
		52.5 mm	2201740	2201746	2201752	2200336	9-pos., green
		67.5 mm	2201486	2201516	2201517	2201521	12-pos., green
		70 mm	2201743	2201749	2201755	2200461	13-pos., green
		90 mm	2201488	2201522	2201524	2201527	17-pos., green

Configure your electronics housing individually in three steps

1 Select the design, color and width of the lower housing part

2 Select matching upper housing part

3 Select connection technology or filler plug

Test the EH series:
Order No. sample set: 52006670

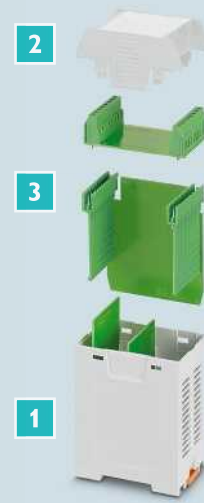

Connection technology







PCB terminal block		Header						Filler plug
5.08 mm pitch	5 mm pitch	5 mm pitch	5.08 mm pitch	5.08 mm pitch	5.08 mm pitch	3.5 mm pitch	3.5 mm pitch	
Mounting position of the PCB								
Horizontal	Horizontal	Horizontal	Horizontal	Vertical	Vertical	Vertical	Vertical	
MKDS 3/...	MKKDSH 3/...	MSTBV 2,5/...	MSTBV 2,5/...	MSTBO 2,5/...	MSTBO 2,5/...	MCO-EH 1,5/...	MCO-EH 1,5/...	EH...-FP/ABS
				Left version	Right version	Left version	Right version	
1712805	1721045	1753479	1758034	1850453	1847123	2202330	2202331	2201843
1701144	1721045	1753518	1758050	1850479	1847149			2201840
1712708	1703283	1753550	1758076	1850495	1847165	2202330	2202331	2201843
1707331	On request	1753576	1758089	On request	On request			2201840
1714308	On request	1753631	1758115	On request	On request			2201843
On request	On request	1753657	1758128	On request	On request			2201840
On request	On request	1753738	1758160	On request	On request			2201843
1712805	1721045	1753479	1758034	1850453	1847123	2202333	2202332	2201842
1701144	1721045	1753518	1758050	1850479	1847149			2201841
1712708	1703283	1753550	1758076	1850495	1847165	2202333	2202332	2201842
1707331	On request	1753576	1758089	On request	On request			2201841
1714308	On request	1753631	1758115	On request	On request			2201842
On request	On request	1753657	1758128	On request	On request			2201841
On request	On request	1753738	1758160	On request	On request			2201842

Configuration overview

ME MAX series

new

i Web code: #0387

1 Lower housing part				2 Upper housing part			3	
Lower housing part Design	Color	Housing width	Order No.	One side open	Both sides open	Both sides closed	PCB terminal block	
							5 mm pitch	
							Horizontal	
								MKDS 3/...
Flat design 	Light gray (similar to RAL 7035)	22.5 mm	2200665	2200674	2201453	2201653	4-pos., green	1712805
		35 mm	2201814	2201820	2201826	2201832	6-pos., green	1701144
		45 mm	2200474	2200789	2201770	2201769	8-pos., green	1712708
		52.5 mm	2201816	2201822	2201829	2201835	9-pos., green	1707331
		67.5 mm	2200519	2201097	2201773	2201774	12-pos., green	1714308
		70 mm	2201819	2201825	2201830	2201836	13-pos., green	On request
		90 mm	2200663	2201282	2201778	2201777	17-pos., green	On request
Flat design 	Black (similar to RAL9005)	22.5 mm	2200666	2201452	2201456	2201765	4-pos., green	1712805
		35 mm	2201815	2201821	2201827	2201833	6-pos., green	1701144
		45 mm	2200492	2201448	2201771	2201766	8-pos., green	1712708
		52.5 mm	2201817	2201823	2201828	2201834	9-pos., green	1707331
		67.5 mm	2200520	2201447	2201772	2201775	12-pos., green	1714308
		70 mm	2201818	2201824	2201831	2201837	13-pos., green	On request
		90 mm	2200664	2201388	2201779	2201776	17-pos., green	On request

Configure your electronics housing individually in three steps

1 Select the design, color and width of the lower housing part

2 Select matching upper housing part

3 Select connection technology or filler plug

Test the EH series:

Order No. sample set: 52006670

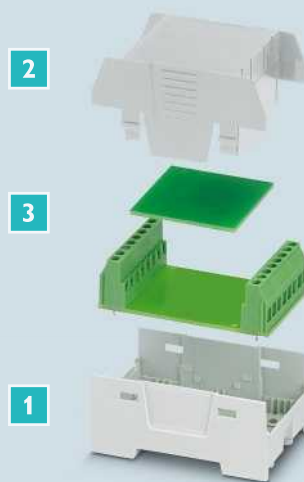









Connection technology

		Header					Filler plug	
5 mm pitch	5 mm pitch	5.08 mm pitch		5 mm pitch		3.81 mm pitch		
Mounting position of the PCB								
Horizontal	Horizontal	Horizontal		Horizontal		Horizontal		
MKKDSH 3/...	MSTBV 2,5/...	MSTBV 2,5/...		PST 1,3/...		MCV 1,5/...		
1721045	1753479	1758034	4-pos., black	1933202	5-pos., green	1803455	2201844	
1721045	1753518	1758050	6-pos., black	1933228	8-pos., green	1803484	2201847	
1703283	1753550	1758076	8-pos., black	1933244	10-pos., green	1803507	2201844	
On request	1753576	1758089	9-pos., black	1933257	12-pos., green	1803523	2201847	
On request	1753631	1758115	12-pos., black	1933286	16-pos., green	1803565	2201844	
On request	1753657	1758128	12-pos., black	1933299	16-pos., green	1803565	2201847	
On request	1753738	1758160	17-pos., black	1935556	21-pos., green	On request	2201844	
1721045	1753479	1758034	4-pos., black	1933202	5-pos., green	1803455	2201845	
1721045	1753518	1758050	6-pos., black	1933228	8-pos., green	1803484	2201846	
1703283	1753550	1758076	8-pos., black	1933244	10-pos., green	1803507	2201845	
On request	1753576	1758089	9-pos., black	1933257	12-pos., green	1803523	2201846	
On request	1753631	1758115	12-pos., black	1933286	16-pos., green	1803565	2201845	
On request	1753657	1758128	12-pos., black	1933299	16-pos., green	1803565	2201846	
On request	1753738	1758160	17-pos., black	1935556	21-pos., green	On request	2201845	

Configuration overview

ME housing series

i Web code: #0305

1 Lower housing part							
Housing	Housing width	Without Bus connector	With integrated bus connector				For DIN rail Bus connector
			Number of positions: 5	Number of positions: 5 parallel + 2 serial	Number of positions: 10 parallel	Number of positions: 10 parallel + 2 serial	
							
	Type	ME...UT	ME...UT BUS/5	ME ..UT/FE..BUS 5+2	ME...UT BUS/10	ME ..UT/FE..BUS 10+2	ME...TBUS
 <p>Tall design (standard) Total height 114.5 mm *)</p>	12.5 mm, open	2869430					
	17.5 mm, open	2869427	2201851	2201855	2854034	2201859	2914783
	22.5 mm, open	2907732	2201852	2201856	2707482	2200740	2869524
	35 mm, open	2915148	2201853	2201857	2854050	2201860	2914819
	45 mm, open	2709655	2201854	2201858	2200259	2200739	2869511
	67.5 mm, open	2201238			2200537	2200539	2200541
 <p>Flat design Total height 106 mm *)</p>	90 mm, open	2200279		2200538	2200540	2200543	2200545
	22.5 mm	2709781					2914835
 <p>Ultra-flat design Total height 92 mm *)</p>	22.5 mm	2201861					

Configure your electronics housing individually in four steps

- 1 Select lower housing part
- 2 Expand DIN rail bus as an option
- 3 Select matching upper housing part
- 4 Select connection technology or filler plug (p. 30-33)

Test the ME series:
Order No. sample set: 52005214

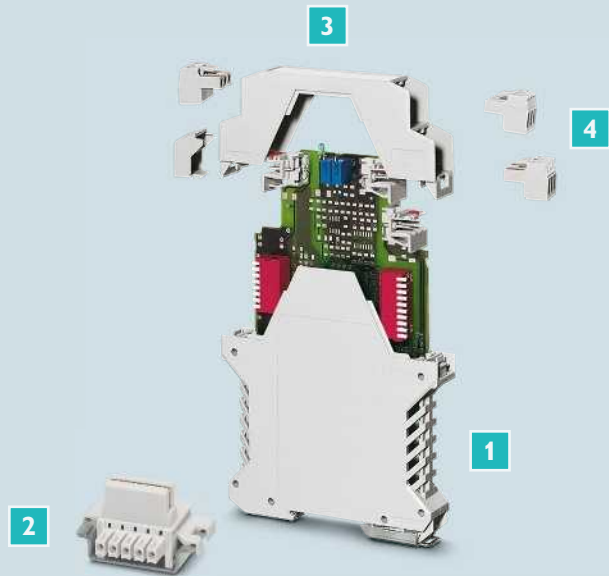

2

DIN rail bus

Number of positions:
5 parallel

Number of positions:
4 parallel + 1 serial

Number of positions:
5

3.81 mm pitch

3.81 mm pitch

3.81 mm pitch



ME...TBUS

ME...TBUS...4P1S

ME...TBUS
ADAPTER

2713645

2201731

2201757

2713722

2201732

2201756

2 × 2713645

2 × 2201731

2201757

2 × 2713722

2 × 2201732

2201756

3 × 2713722

3 × 2201732

2201756

4 × 2713722

4 × 2201732

2201756

2713722

2201732

2201756

2713722

2201732

2201756

3

Upper housing part

PCB terminal blocks

Connector with base strip

Screw connection

Spring connection

Single-level

Double-level

Triple-level



ME...OTU-MKDSO

ME...OT-FKDSO

ME...OT-1MSTBO

ME...OT-MSTBO

ME...OT-3MSTBO

2278869

2200321

2854775

2278940

2200322

2853747

2278953

2200323

2914877

2907761

2914880

2 × 2278940

2 × 2200322

2914864

2 × 2278953

2200327

2709299

2854429

2 × 2914880

3 × 2278953

3 × 2200323

2200522

3 × 2907761

3 × 2914880

4 × 2278953

2 × 2200327

2200523

2 × 2854429

4 × 2914880

22788953

2200321

2914877

2907761

2914880

2278953

2200321

2914877

2907761

2914880

(*) Dimensions of the housing, including single- or double-level upper part.

Configuration overview

ME connection technology series

i Web code: #0305

Upper housing part	Housing width	Maximum number of positions			4				
		Pitch			3.5 mm pitch				
		3.5 mm	5.0 mm	7.25 mm	MCO 1,5/...-3,5		MC	FMC	FK-MCP
				Left	Right				
ME...OT-1MSTBO 	22.5 mm	5	4	3	2278380	2278351	1769087	1773581	1773604
	45 mm	10	8	6	2278380	2278351	1769087	1773581	1773604
	67.5 mm	15	12	9	2278380	2278351	1769087	1773581	1773604
	90 mm	20	16	12	2278380	2278351	1769087	1773581	1773604
ME...OT-MSTBO 	12.5 mm	12	8		2278319	2278322	1769061		
	17.5 mm	16	12	8	2278364	2278377	1769074	1773578	1773594
	22.5 mm	20	16	12	2278380	2278351	1769087	1773581	1773604
	35 mm	32	24	16	2278364	2278377	1769074	1773578	1773594
	45 mm	40	32	24	2278380	2278351	1769087	1773581	1773604
ME...OT-3MSTBO 	22.5 mm	30	24		2278380	2278351	1769087	1773581	1773604

Configure your electronics housing individually in four steps

- 1 Select lower housing part (p. 28-29)
- 2 Add DIN rail bus as an option (p. 28-29)
- 3 Select matching upper housing part (p. 28-29)
- 4 Select connection technology or filler plug

Test the ME series:
Order No. sample set: 52005214

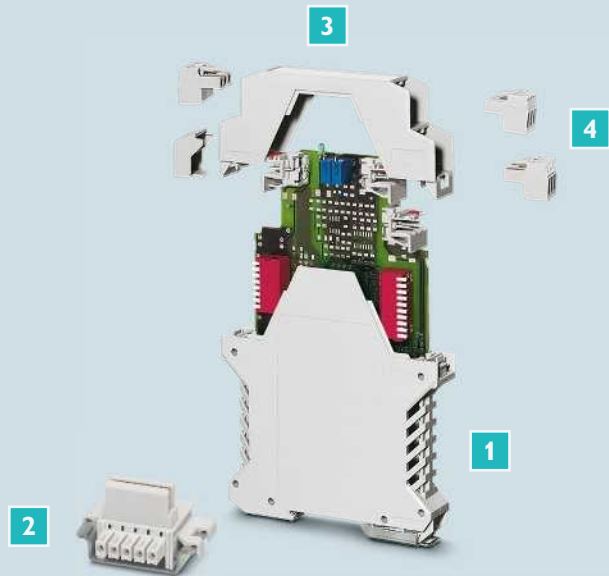





Connection technology

Header and plug										Filler plug	
5 mm pitch			5 mm pitch			5 mm pitch					
MSTBO 2,5/...-G1...		MSTBT	FKCT	MSTBO 2,5/...-G1... THR		MSTBT	FKCT	MSTBO 2,5/...-G1P...		MSTBT...STP	ME B-...
Left	Right			Left	Right			Left	Right		
2907774	2907787	1878037	1921900	2697194	2697204	1878037	1921900	2200325	2200326	2200332	2907965
2907774	2907787	1878037	1921900	2697194	2697204	1878037	1921900	2200325	2200326	2200332	2907965
2907774	2907787	1878037	1921900	2697194	2697204	1878037	1921900	2200325	2200326	2200332	2907965
2907774	2907787	1878037	1921900	2697194	2697204	1878037	1921900	2200325	2200326	2200332	2907965
2854788	2854791	1920545		2200251	2200252	1920545		2200330	2200331	2200334	2854801
2853750	2853763	1971947	1998263	2915216	2915229	1971947	1998263	2200328	2200329	2200333	2853776
2907774	2907787	1878037	1921900	2697194	2697204	1878037	1921900	2200325	2200326	2200332	2907965
2853750	2853763	1971947	1998263	2915216	2915229	1971947	1998263	2200328	2200329	2200333	2853776
2907774	2907787	1878037	1921900	2697194	2697204	1878037	1921900	2200325	2200326	2200332	2907965
2907774	2907787	1878037	1921900	2697194	2697204	1878037	1921900	2200325	2200326	2200332	2 x 2709176

Configuration overview

ME connection technology series

i Web code: #0305



Upper housing part	Housing width	Maximum number of positions		4 PCB terminal block			
		Pitch		Screw connection			
		3.5 mm	5 mm	3.5 mm pitch		5 mm pitch	
							
				MKDSO 1,5/...-3,5		MKDSO 2,5/...	
				Left	Right	Left	Right
ME...OTU-MKDSO	12.5 mm	12	8	2278445	2278458	2915261	2915258
	17.5 mm	16	12	2278432	2278429	2854102	2854092
	22.5 mm	20	16	2278393	2278416	2908485	2908475
	45 mm	40	32	2278393	2278416	2908485	2908472
ME...OT-FKDSO	12.5 mm		8				
	17.5 mm		12				
	22.5 mm		16				
	45 mm		32				

Configure your electronics housing individually in four steps

- 1 Select lower housing part (p. 28-29)
- 2 Add DIN rail bus as an option (p. 28-29)
- 3 Select matching upper housing part (p. 28-29)
- 4 Select connection technology or filler plug

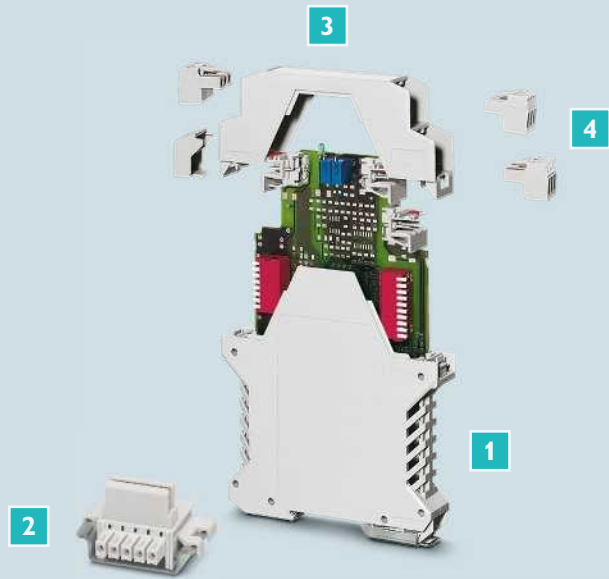
Test the ME series:
Order No. sample set: 52005214









Spring connection		Filler plugs for upper housing part
5 mm pitch		
		
FKDSO 2,5/...		ME B- ...
Left	Right	
		2201862
		2854115
		2908498
		2908498
2200315	2200316	2200565
2200318	2200317	2200566
2200319	2200320	2200567
2200319	2200320	2200567

Configuration overview

ME-MAX housing series

i Web code: #0306

1 Housing													
Housing	Housing width	Order No.	Pitch			Order No.	Pitch			Order No.	Pitch		
		Housing ME MAX ... 3-3	3.5 mm	5.0 mm	7.5 mm	Housing ME MAX ... 2-2	3.5 mm	5.0 mm	7.5 mm	Housing ME MAX ... U-U1	3.5 mm	5.0 mm	7.5 mm
			Max. number of positions for ME-MAX ... 3-3				Max. number of positions for ME-MAX ... 2-2				Max. number of positions for ME-MAX ... U-U1		
													
Tall design (standard) Total height 114.5 mm 	6.2 mm	2869634* 2869647*	8										
	12.5 mm, open 12.5 mm, closed	2279020 2279017	18	12									
	17.5 mm, open 17.5 mm, closed	2713612 2713531	24	18	12	2713599 2713609	16	12	8	2713641 2713515	4	3	2
	22.5 mm, open 22.5 mm, closed	2713939 2713942	30	24	18	2713625 2713638	20	16	12	2713476 2713489	5	4	3
	35 mm, open 35 mm, closed	2713696 2713544	48	36	24	2713670 2713683	32	24	16	2713667 2713528	8	6	4
	45 mm, open 45 mm, closed	2713913 2713926	60	48	36	2713706 2713719	40	32	24	2713492 2713502	10	8	6
	67.5 mm, open 67.5 mm, closed	2200526 2200527	90	72	54	2200524 2200525	60	48	36	2200547 2200528	15	12	9
	90 mm, open 90 mm, closed	2200531 2200532	120	96	72	2200529 2200530	80	64	48	2200546 2200533	20	16	12
Flat design Total height 92 mm 	22.5 mm	2869388	30	24	18								
	45 mm	2869391	60	48	36								
Ultra-flat design Total height 70.4 mm 	17.5 mm					2901369	16	12	8				
	22.5 mm					2869362	20	16	12				
	45 mm					2869375	40	32	24				

Configure your electronics housing individually in three steps

- 1 Select housing
- 2 Expand DIN rail bus and power connectors as an option
- 3 Select connection technology or filler plug (p. 36-37)

Test the ME-MAX series:
Order No. sample set: 52005224

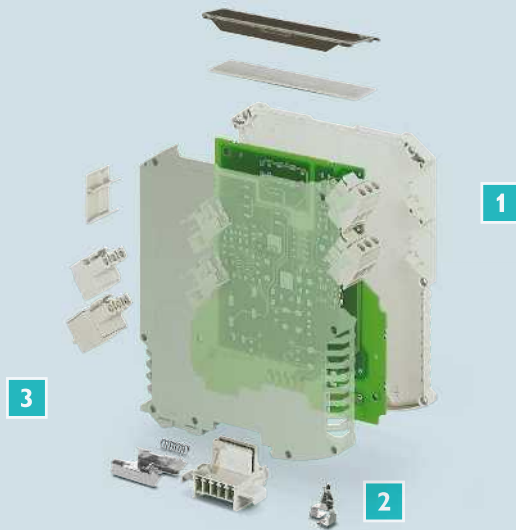



				2 DIN rail connector			2 Power connectors up to 42 A			
Order No.	Pitch			3.81 mm pitch	3.81 mm pitch	3.81 mm pitch				
Housing ME MAX ... 3-U1	3.5 mm	5.0 mm	7.25 mm 7.5 mm	ME ... TBUS ... 1,5/5	ME ... TBUS ... 1,5/4P1S	ME ... TBUS Adapter	PCO ...L**	PBR 42A RD	PBR 42A BU	PBR 42A GY
	Max. number of positions for ME-MAX ... 3-U1			5 parallel positions	4 parallel positions, 1 serial position	Adapter piece, 5 positions	Left	Cross connection		
				2969401						
				2969401						
2201536 2201537	16	12	8	2713645	2201731	2201757	2201684	2201915	2201916	2201917
2201538 2201539	20	16	12	2713722	2201732	2201756	2201685	2201915	2201916	2201917
				2 x 2713645	2 x 2201731	2201757	2201684	2201915	2201916	2201917
2201682 2201683	40	32	24	2 x 2713722	2 x 2201732	2201756	2201685	2201915	2201916	2201917
				3 x 2713722	3 x 2201732	2201756	2201685	2201915	2201916	2201917
				4 x 2713722	4 x 2201732	2201756	2201685	2201915	2201916	2201917
				2713722	2201732	2201756	2201685	2201915	2201916	2201917
				2 x 2713722	2 x 2201732	2201756	2201685	2201915	2201916	2201917
				2713645	2201731		2201684	2201915	2201916	2201917
				2713722	2201732	2201756	2201685	2201915	2201916	2201917
				2 x 2713722	2 x 2201732	2201756	2201685	2201915	2201916	2201917

(*) ME-MAX 6,2 has four connection levels. (***) Note: A ME-MAX can only be swung in together with a PCO on the DIN rail if it is the following high model: ME-MAX ... 2-2.

Configuration overview

ME-MAX connection technology series

i Web code: #0306

1 Housing						3					
Housing	Housing width	Order No.	Order No.	Order No.	Order No.	3.5 mm pitch					
		Housing ME MAX ... 3-3	Housing ME MAX ... 2-2	Housing ME MAX ... U-U1	Housing ME MAX ... 3-U1	MCO 1,5/...G1...-3,5		MC	FMC	FK-MCP	
		Left	Right								
 <p>Tall design (standard) Total height 114.5 mm</p>	6.2 mm	2869634* 2869647*									
	12.5 mm, open 12.5 mm, closed	2279020 2279017				2278319	2278322	1769061			
	17.5 mm, open 17.5 mm, closed	2713612 2713531	2713599 2713609	2713641 2713515	2201536 2201537	2278364	2278377	1769074	1773578	1773594	
	22.5 mm, open 22.5 mm, closed	2713939 2713942	2713625 2713638	2713476 2713489	2201538 2201539	2278380	2278351	1769087	1773581	1773604	
	35 mm, open 35 mm, closed	2713696 2713544	2713670 2713683	2713667 2713528		2278364	2278377	1769074	1773578	1773594	
	45 mm, open 45 mm, closed	2713913 2713926	2713706 2713719	2713492 2713502	2201682 2201683	2278380	2278351	1769087	1773581	1773604	
	67.5 mm, open 67.5 mm, closed	2200526 2200527	2200524 2200525	2200547 2200528		2278380	2278351	1769087	1773581	1773604	
	90 mm, open 90 mm, closed	2200531 2200532	2200529 2200530	2200546 2200533		2278380	2278351	1769087	1773581	1773604	
 <p>Flat design Total height 92 mm</p>	22.5 mm	2869388			2278380	2278351	1769087	1773581	1773604		
	45 mm	2869391			2278380	2278351	1769087	1773581	1773604		
 <p>Ultra-flat design Total height 70.4 mm</p>	17.5 mm		2901369		2278364	2278377	1769074	1773578	1773594		
	22.5 mm		2869362		2278380	2278351	1769087	1773581	1773604		
	45 mm		2869375		2278380	2278351	1769087	1773581	1773604		

Configure your electronics housing individually in three steps

- 1 Select housing (p. 34-35)
- 2 Add DIN rail bus and power connectors as an option (p. 34-35)
- 3 Select connection technology or filler plug

Test the ME-MAX series:
Order No. sample set: 52005224

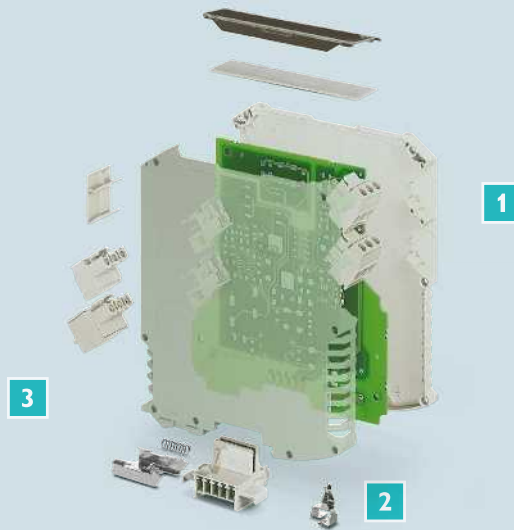

Connection technology

Header and plug



5 mm pitch			5 mm pitch				5 mm pitch			7.25 mm pitch					
MSTBO 2,5/...-G1...		MSTBT	FKCT		MSTBO 2,5/...-G1... THR		MSTBT	FKCT		MSTBO 2,5/...- G1P...	MSTBT... STP	GMSTBO 2,5 HV/...- -G... THR...		GMSTBT 2,5 HV	ME MAX B-...
Left	Right		Left	Right	Right		Left	Right		Left	Right	Left	Right		
2854788	2854791	1920545		2200251	2200252	1920545		2200330	2200331	2200334					2914660
2853750	2853763	1971947	1998263	2915216	2915229	1971947	1998263	2200328	2200329	2200333	2199867	2199760	2199757	2706959	
2907774	2907787	1878037	1921900	2697194	2697204	1878037	1921900	2200325	2200326	2200332	2199663	2199566	2199553	2707929	
2853750	2853763	1971947	1998263	2915216	2915229	1971947	1998263	2200328	2200329	2200333	2199867	2199760	2199757	2706959	
2907774	2907787	1878037	1921900	2697194	2697204	1878037	1921900	2200325	2200326	2200332	2199663	2199566	2199553	2707929	
2907774	2907787	1878037	1921900	2697194	2697204	1878037	1921900	2200325	2200326	2200332	2199663	2199566	2199553	2707929	
2907774	2907787	1878037	1921900	2697194	2697204	1878037	1921900	2200325	2200326	2200332	2199663	2199566	2199553	2707929	
2907774	2907787	1878037	1921900	2697194	2697204	1878037	1921900	2200325	2200326	2200332	2199663	2199566	2199553	2707929	
2853750	2853763	1971947	1998263	2915216	2915229	1971947	1998263	2200328	2200329	2200333	2199867	2199760	2199757	2706959	
2907774	2907787	1878037	1921900	2697194	2697204	1878037	1921900	2200325	2200326	2200332	2199663	2199566	2199553	2707929	
2907774	2907787	1878037	1921900	2697194	2697204	1878037	1921900	2200325	2200326	2200332	2199663	2199566	2199553	2707929	

(*) ME MAX 6,2 has four connection levels.

Configuration overview

ME-MAX series connection technology series

i Web code: #0306

1 Housing						3	
Housing	Housing width	Order No.	Order No.	Order No.	Order No.	3.5 mm pitch	
		Housing ME MAX ... 3-3	ME MAX ... 2-2 housing	ME MAX ... U-U1 housing	ME MAX ... 3-U1 housing	MKDSO 1,5	
						Left	Right
Tall design (standard) Total height 114.5 mm 	6.2 mm	2869634* 2869647*					
	12.5 mm, open 12.5 mm, closed	2279020 2279017				2278445	2278458
	17.5 mm, open 17.5 mm, closed	2713612 2713531	2713599 2713609	2713641 2713515	2201536 2201537	2278432	2278429
	22.5 mm, open 22.5 mm, closed	2713939 2713942	2713625 2713638	2713476 2713489	2201538 2201539	2278393	2278416
	35 mm, open 35 mm, closed	2713696 2713544	2713670 2713683	2713667 2713528		2278392	2278429
	45 mm, open 45 mm, closed	2713913 2713926	2713706 2713719	2713492 2713502	2201682 2201683	2278393	2278416
	67.5 mm, open 67.5 mm, closed	2200526 2200527	2200524 2200525	2200547 2200528		2278393	2278416
	90 mm, open 90 mm, closed	2200531 2200532	2200529 2200530	2200546 2200533		2278393	2278416
Flat design Total height 92 mm 	22.5 mm	2869388				2278393	2278416
	45 mm	2869391				2278393	2278416
Ultra-flat design Total height 70.4 mm 	17.5 mm		2901369			2278431	2278429
	22.5 mm		2869362			2278393	2278416
	45 mm		2869375			2278393	2278416

Configure your electronics housing individually in three steps

- 1 Select housing (p. 34-35)
- 2 Add DIN rail bus and power connectors as an option (p. 34-35)
- 3 Select connection technology or filler plug

Test the ME-MAX series:
Order No. sample set: 52005224

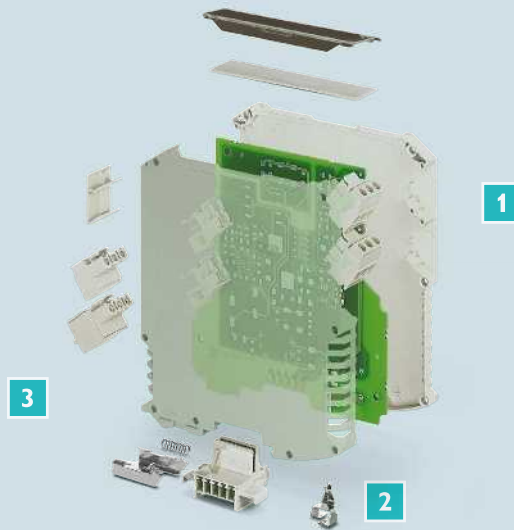

Connection technology





5 mm pitch		7.5 mm pitch		5 mm pitch		7.5 mm pitch		ME MAX B-...
MKDSO 2,5		MKDSO 2,5 HV		FKDSO 2,5		FKDSO 2,5 HV		
Left	Right	Left	Right	Left	Right	Left	Right	
2713094 (**)				2713104 (**)				
2915261	2915258			2200315	2200316			
2854102	2854092	2199676	2199773	2200318	2200317			2914660
2908485	2908472	2890946	2890959	2200319	2200320	2201128	2201129	2706959
2854102	2854092	2199676	2199773	2200318	2200317			2707929
2908485	2908472	2890946	2890959	2200319	2200320	2201128	2201129	2706959
2908485	2908472	2890946	2890959	2200319	2200320	2201128	2201129	2707929
2908485	2908472	2890946	2890959	2200319	2200320	2201128	2201129	2707929
2908485	2908472	2890946	2890959	2200319	2200320	2201128	2201129	2707929
2908485	2908472	2890946	2890959	2200319	2200320	2201128	2201129	2707929
2854102	2854092	2199676	2199773	2200318	2200317			2706959
2908485	2908472	2890946	2890959	2200319	2200320	2201128	2201129	2707929
2908485	2908472	2890946	2890959	2200319	2200320	2201128	2201129	2707929

(*) ME-MAX 6,2 has four connection levels.
(**) ME-MAX 6,2 is available with integrated print and spring connection technology.

Configuration overview

ME-IO series

i Web code: #0308

1				36	34	28	
		Order No.	Order designation			28	20 + 4 TWIN
Lower housing part with Lock and Release							
2		2201960	ME-IO 18,8 B/FE 9/9U TBUS 7035	1 x	1 x		
		2201961	ME-IO 18,8 B/FE 7/9U TBUS 7035			1 x	1 x
		2201962	ME-IO 18,8 B/FE 5/9U TBUS 7035				
		2201963	ME-IO 18,8 B/FE 3/9U TBUS 7035				
		2201809	ME-IO 18,8 B/FE 9U TBUS 7035				
		2201813	ME 18,8 TBUS 1,5/5-ST-3,81KMGY				
Housing cover							
3		2201799	ME-IO 18,8 C 2U 7035			1 x	1 x
		2201800	ME-IO 18,8 C 3U 7035				
		2201802	ME-IO 18,8 C 4U 7035				
		2201803	ME-IO 18,8 C 5U 7035				
		2201804	ME-IO 18,8 C 6U 7035				
		2201806	ME-IO 18,8 C 9U 7035				
Connection technology							
4		Header					
		2201788	HSCH 2,5-3U/12 9005	1 x	1 x	1 x	1 x
		2201789	HSCH 2,5-2U/ 8 9005	3 x	1 x	2 x	1 x
		2201790	HSCH 2,5-2U-TTTT 9005				1 x
	2201792	HSCH 2,5-2U-2220 9005		2x			
		Plug with push-in spring connection					
		2201780	HSCP-SP 2,5-1U/ 4 7035	9 x	7 x	7 x	5 x
		2201781	HSCP-SP 2,5-1U-TT 7035				2 x
		2201782	HSCP-SP 2,5-1U-20 7035		2 x		

Individually configure electronics housing with connection technology

1 Determine assignment for no. of positions

2 Define lower housing part

3 Select housing cover

4 Select connection technology

Test the ME-IO series:
Order No. sample set: 52005220

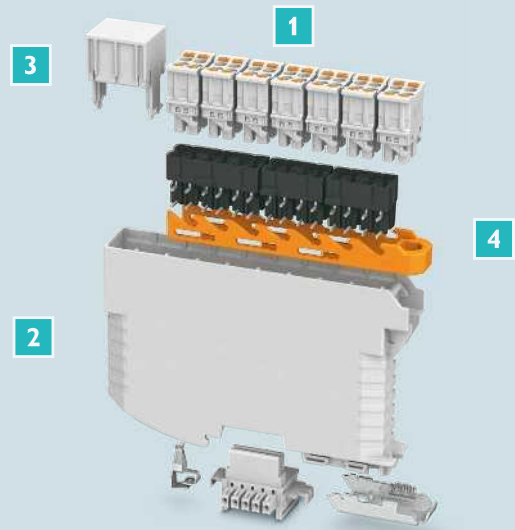

Number of positions configuration



Number of positions

24		20		16		12	8		0	
24	16 + 4 TWIN	24	20	12 + 4 TWIN	16	8 + 4 TWIN	12	8	4 TWIN	0
		1 x								
1 x	1 x									
			1 x	1 x	1 x	1 x				
							1 x	1 x	1 x	
										1 x
Optional selection										
1 x	1 x	1 x								
			1 x	1 x						
					1 x	1 x				
							1 x			
								1 x	1 x	
										1 x
		2 x	1 x	1 x			1 x			
3 x	2 x		1 x		2 x	1 x		1 x		
	1 x			1 x		1 x			1 x	
6 x	4 x	6 x	5 x	3 x	4 x	2 x	3 x	2 x		
	2 x			2 x		2 x			2 x	

Additional configurations possible.

Configuration overview

ME-PLC series

i Web code: #0309

	Description	Type	Order No.
Lower housing parts			
1	For 50-/40-pos. bus connector	ME PLC 40 B BUS 50/40 GY7035	2201500
	For 10-/10-pos. bus connector	ME PLC 40 B BUS 10/10 GY7035	2201499
Housing termination			
2	Cover, light gray	ME PLC 40 CS GY7035	2201490
	Insert plate, light gray	ME PLC 40 PL S GY7035	2201497
	Cover, transparent	ME PLC 40 CS TRANS	2201491
	Matrix, black for transparent cover	ME PLC 40 MT S BK	2201496
Front connection module			
3	Universal cover, permanently snapped in	ME PLC 40 CL GY7035	2201505
	Including 2 x 10-pos. FKCN connection technology, swiveling	ME PLC 40 CT20 GY7035	2201493
	Including 2 x 18-pos. FKCN connection technology, swiveling	ME PLC 40 CT36 GY7035	2201494
	Including 1 x 10-pos. FKCN connection technology, swiveling	ME PLC 40 CT10 GY7035	2201492
	Including RJ45 connection technology, permanently snapped in	ME PLC 40 CTRJ45 GY7035	2201495
Bus connector			
4	Set including 50/40-pos. connector without PCB	ME PLC 40 BUS 50/40 KIT BK	2201502
	Set including 2 x 10-pos. connector without PCB	ME PLC 40 BUS 10/10 KIT BK	2201503
Accessories			
5	DIN rail, unperforated 105 x 20 mm, cut to size individually	NS 105/20 UNPERF	2201508
	End bracket for NS 105/20 DIN rail	ME PLC EBT GY7035	2201498

Configure your electronics housing individually in five steps

- 1 Select lower housing part
- 2 Select housing termination
- 3 Select front connection module
- 4 Specify bus connector
- 5 Select accessories

Test the ME-PLC series:
Order No. sample set: 52003927

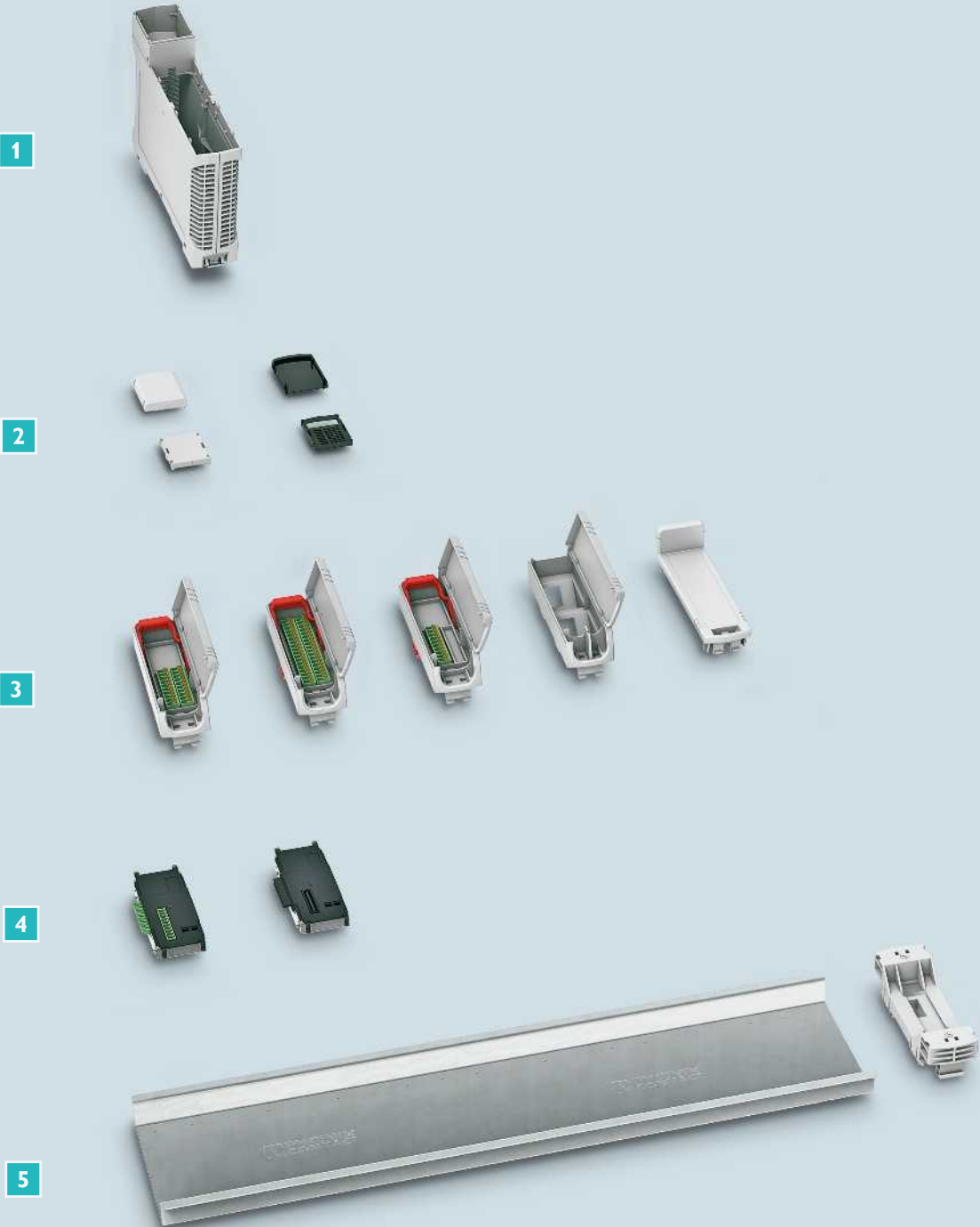

Configuration overview

BC housing series

i Web code: #0311

		Description			2		
1		Lower housing part	Width	Order no.	17.8 mm	35.6 mm	
						11 mm	22 mm
							
		17.8 mm		2896241	2279732 ¹⁾ 2896144 ²⁾ 2896102 ³⁾		
		35.6 mm		2896254		2896034 ¹⁾ 2896157 ²⁾ 2896115 ³⁾	2896047 ¹⁾ 2896157 ²⁾ 2896115 ³⁾
		53.6 mm		2896403			
		71.6 mm		2896267			
		107.6 mm		2896270			
		161.6 mm		2278500			
3		Bus connectors (*)	Type	Number of positions	Slots to the PCB	17.8 mm	35.6 mm
			HBUS 35,6-16P-1S	16	1		2896283
			HBUS 35,6-16P-2S	16	2	2896319	
			HBUS 53,6-16P-1S	16	1		
			HBUS 53,6-16P-3S	16	3	2896322	
			HBUS 71,6-16P-1S	16	1		
			HBUS 107,6-16P-1S	16	1		
	HBUS 161,6-16P-1S	16	1				

Configure your electronics housing individually in three steps

- 1 Select lower housing part
- 2 Select matching upper housing part and cover
- 3 Select bus connector

Test the BC series:
Order No. sample set: 52005225

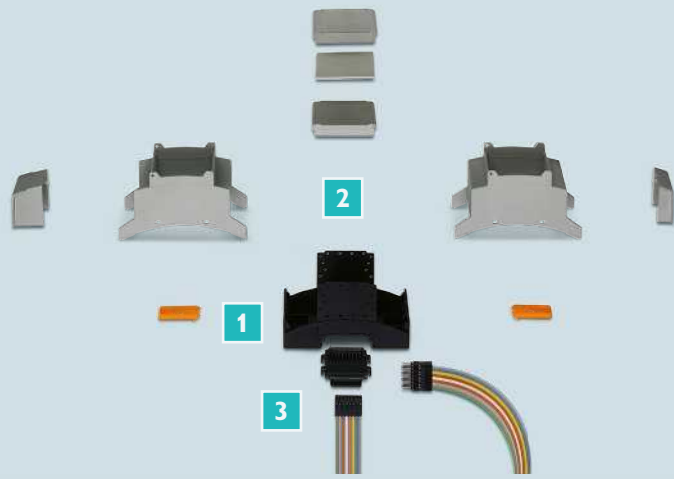

Upper housing part

53.6 mm		71.6 mm		107.6 mm		161.6 mm		
Terminal installation depth								
11 mm	22 mm	11 mm	22 mm	11 mm	22 mm	11 mm	22 mm	Modular
2896416 ¹⁾ 2896432 ²⁾ 2896445 ³⁾	2896429 ¹⁾ 2896432 ²⁾ 2896445 ³⁾	2896050 ¹⁾ 2896160 ²⁾ 2896128 ³⁾	2896063 ¹⁾ 2896160 ²⁾ 2896128 ³⁾	2896076 ¹⁾ 2896173 ²⁾ 2896131 ³⁾	2896089 ¹⁾ 2896173 ²⁾ 2896131 ³⁾	2278513 ¹⁾ 2278539 ²⁾ 2278542 ³⁾	2278526 ¹⁾ 2278539 ²⁾ 2278542 ³⁾	Configurable ¹⁾ 2278539 ²⁾ 2278542 ³⁾
53.6 mm		71.6 mm		107.6 mm		161.6 mm		
2896458		2896296		2896306		2278555		

(*) Suitable power connectors with 16 free cable ends: Order No. 2896348.

(1) Upper housing part. (2) Light gray housing cover, permanently snapped in. (3) Transparent cover including insertion plate.









Configuration overview

BC connection technology series

Connection technology for a max. number of positions per side										
 Web code: #0311										
				Pcs.	17.8	Pcs.	35.6 U11	Pcs.	35.6 U22	Pcs.
	Connection technology	Pitch	Conductor cross section (*)							
	Filler plug for unassembled, largest segment			2	2854115	1	2896209	1	2896212	1
PCB terminal blocks with screw connection										
Currents up to 32 A, for wave soldering processes										
	MKDSO 2,5/3-L	5.0 mm	2.5 mm ²	2	2854102					
	MKDSO 2,5/3-R	5.0 mm	2.5 mm ²	2	2854092					
Currents up to 24 A, for reflow process										
	MKDS 1,5/... HT	5.0 mm	1.5 mm ²			2	1985894	2	1985849	3
	MKDSN 2,5/... HT	5.0 mm	2.5 mm ²			2	1985933	2	1985933	3
Currents up to 32 A, for wave soldering processes										
	MKDS 1,5/...	5.0 mm	1.5 mm ²			2	1715035	2	1715035	3
	MKDSN 2,5/...	5.0 mm	2.5 mm ²			2	1890976	2	1890976	3
	MKKDSH 3/...	5.0 mm	2.5 mm ²			2	1721346	2	1721346	3
Currents up to 41 A, for wave soldering processes										
	GMKDS 1,5/...	7.5 mm	1.5 mm ²			2	1717020	2	1717020	2
	GMKDSP 3/...	7.5 mm	1.5 mm ²			2	1732021	2	1732021	2
Double level										
	MKKDS 1,5/...	5.0 mm	1.5 mm ²					2	1725012	
	MKKDSG 3/...	5.0 mm	2.5 mm ²					1	1721087	
PCB terminal blocks with push-in spring connection										
Currents up to 24 A, for wave soldering processes										
	SPTA 1/...-3,5	3.5 mm	1.0 mm ²			1	1752162	1	1752162	1
	SPTA 1/...-5,0	5.0 mm	1.0 mm ²			1	1752256	1	1752256	1
Currents up to 24 A, for wave soldering processes										
	ZFKKDS 1,5C-5,0	5.0 mm	1.5 mm ²					6	1889301	
PCB terminal blocks with double spring connection										
	FK-MPT 0,5/...-3,5-H	3.5 mm	0.5 mm ²			1	1928822	1	1928822	1
	FK-MPT 0,5/...-ST-3,5	3.5 mm	0.5 mm ²			1	1913989	1	1913989	1
PCB terminal blocks with spring connection										
	PTSA 0,5/...-2,5-Z	2.5 mm	0.5 mm ²			1	1990096	1	1990096	1
	PTSA 0,5/...-2,5-F	2.5 mm	0.5 mm ²			1	1989832	1	1989832	1
	PTS 1,5/...-5,0-H	5.0 mm	2.5 mm ²			1	1792902	1	1792902	1
PCB terminal blocks with screw connection										
	PT 1,5/...-5,0-H	5.0 mm	2.5 mm ²			1	1935200	1	1935200	1
	PT 1,5/...-PH-5,0	5.0 mm	2.5 mm ²			1	1755622	1	1755622	1
PCB terminal blocks with double spring connection										
	PTDA 1,5/...-PH-3,5	3.5 mm	1.5 mm ²					1	1725185	
	PTDA 2,5/...-PH-5,0	5.0 mm	2.5 mm ²					1	1725549	
Pin strips										
	PST 1,3/...-LV-5,0	5.0 mm						1	1704521	
	PST 1,3/...-5,0	5.0 mm				1	1933228	1	1933228	1
RJ-45 connection										
	VS-08-BU-RJ45/LP-1							1	1688586	

Test the BC series:
Order No. sample set: 52005225

Housing
17.8 to 161.6 mm housing and U11 and U22 terminal installation depth)



																	
53.6 U11	Pcs.	53.6 U22	Pcs.	71.6 U11	Pcs.	71.6 U22	Pcs.	107.6 U11	Pcs.	107.6 U22	Pcs.	161.6 U11	Pcs.	161.6 U22	Pcs.	161.6 modular	Connection technology dependent on configuration
2896225	1	2896238	2	2896209	2	2896212	2	2896225	2	2896238	3	2896225	3	2896238	3	2896238	
1985894	3	1985894	4	1985894	4	1985849	6	1984950	6	1984950	9	1984950	9	1984950	9	1984950	
1985933	3	1985933	4	1985933	4	1985933	6	1985933	6	1985933	9	1985933	9	1985933	9	1985933	
1715035	3	1715035	4	1715035	4	1715035	6	1715035	6	1715035	9	1715035	9	1715035	9	1715035	
1890976	3	1890976	4	1890976	4	1890976	6	1890976	6	1890976	9	1890976	9	1890976	9	1890976	
1721346	3	1721346	4	1721346	4	1721346	6	1721346	6	1721346	9	1721346	9	1721346	9	1721346	
1717033	2	1717033	4	1717020	4	1717020	4	1717033	4	1717033	6	1717033	4	1717033	4	1717033	
1732034	2	1732034	4	1732021	4	1732021	4	1732034	4	1732034	6	1732034	4	1732034	4	1732034	
	3	1725025			4	1725012			6	1725025			9	1725025	9	1725025	
	3	1721087			2	1721087			6	1721087			9	1721087	9	1721087	
1752201	1	1752201	2	1752162	2	1752162	2	1752201	2	1752201	3	1752201	3	1752201	3	1752201	
1752298	1	1752298	2	1752256	2	1752256	2	1752298	2	1752298	3	1752298	3	1752298	3	1752298	
		1889259			12	1889301				1889259				1889259		1889259	
1928877	1	1928877	2	1928822	2	1928822	2	1928877	2	1928877	3	1928877	3	1928877	3	1928877	
1914043	1	1914043	2	1913989	2	1913989	2	1914043	2	1914043	3	1914043	3	1914043	3	1914043	
1990148	1	1990148	2	1990096	2	1990096	2	1990148	2	1990148	3	1990148	3	1990148	3	1990148	
1989887	1	1989887	2	1989832	2	1989832	2	1989887	2	1989887	3	1989887	3	1989887	3	1989887	
1792931	1	1792931	2	1792902	2	1792902	2	1792931	2	1792931	3	1792931	3	1792931	3	1792931	
1935239	1	1935239	2	1935200	2	1935200	2	1935239	2	1935239	3	1935239	3	1935239	3	1935239	
1755651	1	1755651	2	1755622	2	1755622	2	1755651	2	1755651	3	1755651	3	1755651	3	1755651	
	1	1725250			2	1725185			2	1725250			3	1725250	3	1725250	
	1	1725649			2	1725549			2	1725649			3	1725649	3	1725649	
	1	1704547			2	1704521			2	1704547			3	1704547	3	1704547	
1933257	1	1933257	2	1933228	2	1933228	2	1933257	2	1933257	3	1933257	3	1933257	3	1933257	
	1	1688586			2	1688586			2	688586			3	1688586	3	1688586	

(*) Based on stranded conductors.

Configuration overview

UM-BASIC series

i Web code: #0313

	Description	Type	Profile widths (internal)		
			72 mm	108 mm	122 mm
	Order key for UM-BASIC profiles				
	Order No. Profile width Length [cm] Color Example: 2200148 / UM-BASIC 72 / 22.5 / GY7035				
	Basic profile				
1	PVC profile, profile section, customer-specific according to order key, color: light gray	UM-BASIC PROFILE CM	2200149	2200149	2200149
	Lateral elements (left) with fastening foot for NS 35 DIN rail, color: light gray	UM-BASIC/PRO ... COVER-L KMGY	2202018	2202021	2202045
	Lateral elements (right) with fastening foot for NS 35 DIN rail, color: light gray	UM-BASIC/PRO ... COVER-R KMGY	2202019	2202022	2202046
	Hood profile				
	Order key for U-shaped profile covers				
	Order No. Cover Length [cm] Example: 2200174 / AU 73 / 20				
2	U-shaped profile cover, low version, 73 mm wide, color: transparent	UM-BASIC/PRO A/U N 73 CM	2202035	2202035	2202035
	U-shaped profile cover, high version, 73 mm wide, color: transparent	UM-BASIC/PRO A/U 73 CM	2202036	2202036	2202036
	U-shaped profile cover, 92 mm wide, color: transparent	UM-BASIC/PRO A/U 92 CM	2202037	2202037	2202037
	Latching cover for UM-BASIC A/U N 73 CM U-shaped profile cover, color: light gray	UM-BASIC/PRO LID-73N KMGY	2202047	2202047	2202047
	Latching cover for UM-BASIC A/U 73 CM U-shaped profile cover, color: light gray	UM-BASIC/PRO LID-73 KMGY	2202033	2202033	2202033
	Latching cover for UM-BASIC A/U N 92 CM U-shaped profile cover, color: light gray	UM-BASIC/PRO LID-92N KMGY	2202034	2202034	2202034
	PE contact metals, including mounting screw				
	Version for top PCB	UM-BASIC/PRO PE CONTACT L1	2202025	2202025	2202025
	Version for middle PCB	UM-BASIC/PRO PE CONTACT L2	2202026	2202026	2202026
	Version for bottom PCB	UM-BASIC/PRO PE CONTACT L3	2202027	2202027	2202027
	Add-on elements for securing PCB				
3	Version for top PCB, lateral, color: light gray	UM-BASIC/PRO PCB S-LOCK KMGY	2202031	2202031	2202031
	Version for top PCB, center, color: light gray	UM-BASIC/PRO PCB C-LOCK L1 KMGY	2202028	2202028	2202028
	Version for middle PCB, center, color: light gray	UM-BASIC/PRO PCB C-LOCK L2 KMGY	2202029	2202029	2202029
	Version for bottom PCB, center, color: light gray	UM-BASIC/PRO PCB C-LOCK L3 KMGY	2202030	2202030	2202030
	Mounting flange, for direct wall mounting, color: light gray	UM-BASIC/PRO MOUNT KMGY	2202032	2202032	2202032
	Foot element for DIN rail for mounting under UM-BASIC PROFILE, color: light gray	UM-BASIC/PRO ... FOOT KMGY	2202020	2202023	2202024
	Screwdriver	SZF 0-0,4X2,5	1204504	1204504	1204504

Configure your electronics housing individually in three steps

- 1** Select basic profile
- 2** Select hood profile
- 3** Select accessories

Test the UM-BASIC series:
Order No. sample set: 52005309

1



2



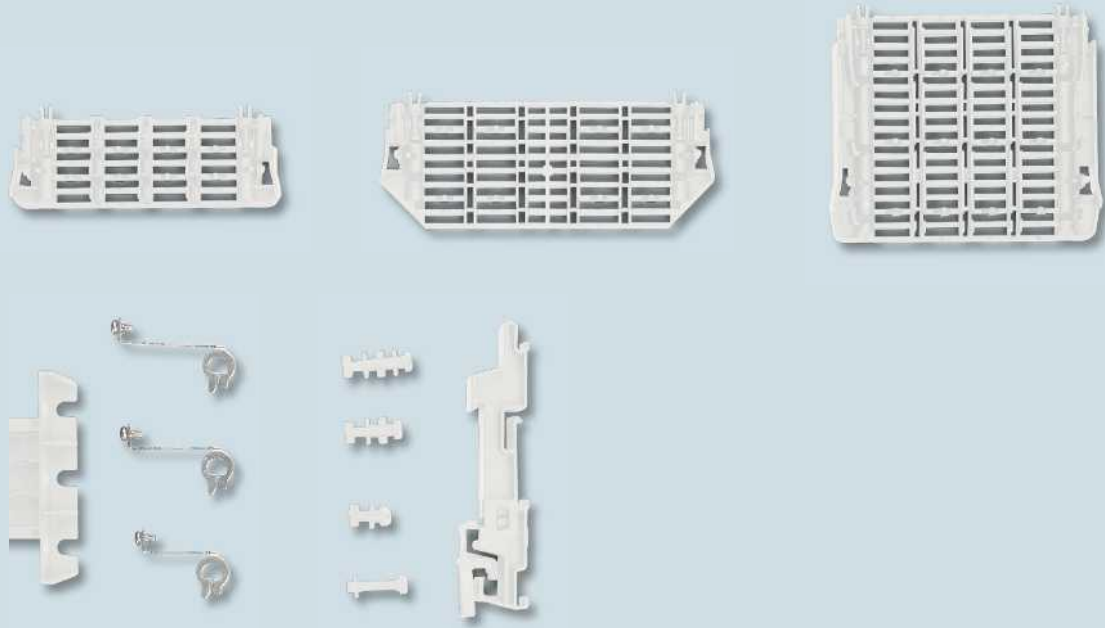

3



Configuration overview

UM-PRO series

i Web code: #0314

	Description	Type	Profile widths (internal)		
			72 mm	108 mm	122 mm
	Order key for UM-BASIC profiles				
	Order No. Profile width Length [cm] Color Example: 2200148 / UM-PRO 72 / 22.5 / GY7035				
1	Basic profile				
	Polyamide profile, customer-specific profile length according to order key	UM-PRO PROFILE CM	2200148	2200148	2200148
	Lateral elements (left) with fastening foot for NS 35 DIN rail	UM-PRO ... COVER-L BK	2200151	2200155	2200158
	Lateral elements (right) with fastening foot for NS 35 DIN rail	UM-PRO ... COVER-R BK	2200152	2200156	2200159
	Hood profile				
	Order key for U-shaped profile covers				
	Order No. Cover Length [cm] Example: 2200174 / AU 73 / 20				
2	U-shaped profile cover, low version, 73 mm wide, color: transparent	UM-PRO A/U N 73 CM	2200310	2200310	2200310
	U-shaped profile cover, high version, 73 mm wide, color: transparent	UM-PRO A/U 73 CM	2200311	2200311	2200311
	U-shaped profile cover, 92 mm wide, color: transparent	UM-PRO A/U 92 CM	2200312	2200312	2200312
	Latching cover for UM-PRO A/U N 73 CM U-shaped profile cover , color: black	UM-PRO LID-73N BK	2200174	2200174	2200174
	Latching cover for UM-PRO A/U 73 CM U-shaped profile cover, color: black	UM-PRO LID-73 BK	2200173	2200173	2200173
	Latching cover for UM-PRO A/U N 92 CM U-shaped profile cover, color: black	UM-PRO LID-92 BK	2200172	2200172	2200172
	PE contact metals, including mounting screw				
	Version for top PCB	UM-PRO PE CONTACT L1	2200161	2200161	2200161
	Version for middle PCB	UM-PRO PE CONTACT L2	2200162	2200162	2200162
	Version for bottom PCB	UM-PRO PE CONTACT L3	2200163	2200163	2200163
	Add-on elements for securing PCB				
3	Version for top PCB, lateral, color: black	UM-PRO PCB S-LOCK BK	2200168	2200168	2200168
	Version for top PCB, center, color: black	UM-PRO PCB C-LOCK L1 BK	2200164	2200164	2200164
	Version for middle PCB, center, color: black	UM-PRO PCB C-LOCK L2 BK	2200165	2200165	2200165
	Version for bottom PCB, center, color: black	UM-PRO PCB C-LOCK L2 BK	2200166	2200166	2200166
	Mounting flange, for direct wall mounting, color: black	UM-PRO MOUNT BK	2200171	2200171	2200171
	Foot element for DIN rail for mounting under UM-PRO PROFILE, color: black	UM-PRO ...FOOT BK	2200153	2200157	2200160
	Screwdriver	SZF 0-0,4X2,5	1204504	1204504	1204504

Configure your electronics housing individually in three steps

- 1** Select basic profile
- 2** Select hood profile
- 3** Select accessories

Test the UM-PRO series:
Order No. sample set: 52005226

1



2



3

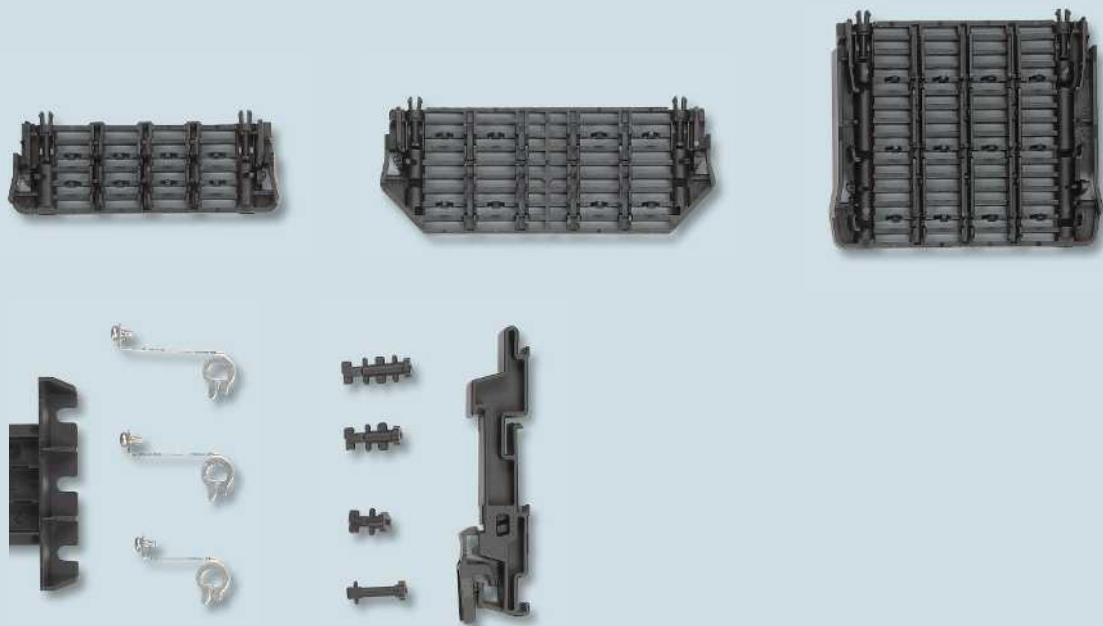

Configuration overview

UM-ALU series

Configure your electronics housing individually in three steps

1 Select basic profile

2 Specify module profile

3 Select accessories

Test the **UM-ALU series:**
Order No. sample set: 52002012

1



2

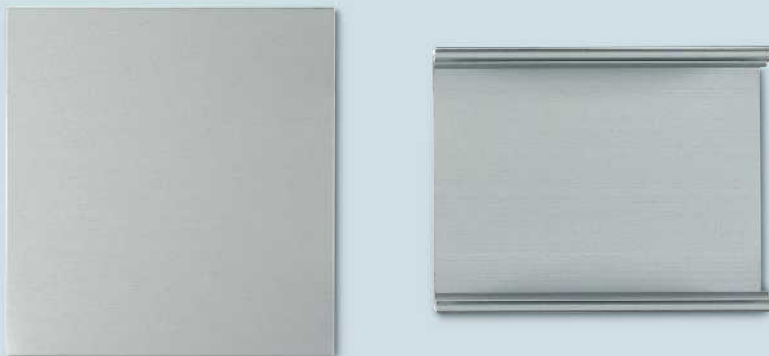



3









Web code: #0315

	Description	Type	Profile width (internal)	
			72 mm	100,5 mm
				
1	Basic profile, one-piece, anodized aluminum			
	Length 42.5 mm	UM-ALU 4-... PROFILE 42,5	2200917	2200935
	Length 60 mm	UM-ALU 4-... PROFILE 60	2200918	2200936
	Length 95 mm	UM-ALU 4-... PROFILE 95	2200919	2200937
	Length 130 mm	UM-ALU 4-... PROFILE 130	2200920	2200938
	Length 165 mm	UM-ALU 4-... PROFILE 165	2200921	2200939
	Length 200 mm	UM-ALU 4-... PROFILE 200	2200922	2200940
	Length 235 mm	UM-ALU 4-... PROFILE 235	2200923	2200941
	Length 990 mm	UM-ALU 4-... PROFILE 990	2200924	2200942
	Side plate set, including snap-on foot, anodized aluminum	UM-ALU 4- ... COVER AL	2200933	2200951
Side plate set, incl. snap-on foot, anodized aluminum for upper part profile width 45 mm	UM-ALU 4- ... COVERLID 45 AL	2201758	2201759	
Side plate set, incl. snap-on foot, anodized aluminum for upper part profile width 75 mm	UM-ALU 4- ... COVERLID 75 AL	2202085	2201760	
2	Module profile, upper part with 45 mm profile width, anodized aluminum			
	Length 42.5 mm	UM-ALU 4 AU45 L42,5	2200954	2200954
	Length 60 mm	UM-ALU 4 AU45 L60	2200955	2200955
	Length 95 mm	UM-ALU 4 AU45 L95	2200956	2200956
	Length 130 mm	UM-ALU 4 AU45 L130	2200957	2200957
	Length 165 mm	UM-ALU 4 AU45 L165	2200958	2200958
	Length 200 mm	UM-ALU 4 AU45 L200	2200959	2200959
	Length 235 mm	UM-ALU 4 AU45 L235	2200960	2200960
	Length 990 mm	UM-ALU 4 AU45 L990	2200961	2200961
	Module profile, upper part with 75 mm profile width, anodized aluminum			
	Length 42.5 mm	UM-ALU 4 AU75 L42,5	2200963	2200963
	Length 60 mm	UM-ALU 4 AU75 L60	2200964	2200964
	Length 95 mm	UM-ALU 4 AU75 L95	2200965	2200965
	Length 130 mm	UM-ALU 4 AU75 L130	2200966	2200966
	Length 165 mm	UM-ALU 4 AU75 L165	2200967	2200967
	Length 200 mm	UM-ALU 4 AU75 L200	2200968	2200968
	Length 235 mm	UM-ALU 4 AU75 L235	2200969	2200969
	Length 990 mm	UM-ALU 4 AU75 L990	2200970	2200970
Basic profile front plate, anodized aluminum				
Length 42.5 mm	UM-ALU 4- ... FRONT 42,5 AP	2202086	2202094	
Length 60 mm	UM-ALU 4- ... FRONT 60 AP	2202087	2202095	
Length 95 mm	UM-ALU 4- ... FRONT 95 AP	2202088	2202096	
Length 130 mm	UM-ALU 4- ... FRONT 130 AP	2202089	2202098	
Length 165 mm	UM-ALU 4- ... FRONT 165 AP	2202090	2202099	
Length 200 mm	UM-ALU 4- ... FRONT 200 AP	2202091	2202100	
Length 235 mm	UM-ALU 4- ... FRONT 235 AP	2202092	2202101	
Length 990 mm	UM-ALU 4- ... FRONT 990 AP	2202093	2202102	
3	Accessories			
	Snap-on foot for DIN rail, including screw (optional)	UM-ALU 4 FOOT	2200974	2200974

Configuration overview

HC-ALU series

i Web code: #0317

	Description	Type	Width (internal)			
			53.5 mm	78 mm	100.5 mm	161 mm
						
Aluminum profile split						
1	Profile section 100 mm	HC-ALU 6-... PROFILE 100	2200887	2200892	2200897	2200902
	Profile section 150 mm	HC-ALU 6-... PROFILE 150	2200888	2200893	2200898	2200903
	Profile section 200 mm	HC-ALU 6-... PROFILE 200	2200889	2200894	2200899	2200904
	Profile section 1000 mm	HC-ALU 6-... PROFILE 1000	2200890	2200895	2200900	2200905
Cover						
2	End cover, with screws and seal	HC-ALU 6-... COVER GY	2200891	2200896	2200901	2200906
	End cover, with hinged cover, screws and seal	HC-ALU 6-... DKL-COVER GY	2201121	2201122	2201123	
	EMC seal (optional)	HC-ALU 6-... SEAL EMC	2200907	2200908	2200909	2200910
Accessories						
3	Decorative strip, dark gray, length = 98.4 mm	HC-ALU 6 DECO 100 GY	2200914	2200914	2200914	2200914
	Decorative strip, dark gray, length = 148.4 mm	HC-ALU 6 DECO 150 GY	2200915	2200915	2200915	2200915
	Decorative strip, dark gray, length = 198.4 mm	HC-ALU 6 DECO 200 GY	2200916	2200916	2200916	2200916
	Panel fastening, including cover caps, for 100 mm profile section	HC-ALU 6 MOUNT 100 GY	2200911	2200911	2200911	2201327
	Panel fastening, including cover caps, for 150 mm profile section	HC-ALU 6 MOUNT 150 GY	2200912	2200912	2200912	2201332
	Panel fastening, including cover caps, for 200 mm profile section	HC-ALU 6 MOUNT 200 GY	2200913	2200913	2200913	2201334
	Torx® screwdriver set with TX 10x80	SF-TXH SET	1212538	1212538	1212538	1212538
	Bit screwdriver set with quick-action chuck	SF-M SET	1212543	1212543	1212543	1212543
4	M12 flush-type connector and cables, see www.phoenixcontact.com					

Configure your electronics housing individually in just four steps

- 1 Define profile
- 2 Select cover
- 3 Select accessories
- 4 Define connection technology

Test the HC-ALU series:
Order No. sample set: 52002014

1



2



3



4



Light guides for electronics housings

new

Series	Order number	Item name	Alignment	Display size	Number of displays	Pitch
	2202311	HS LC-V-D3/ R2xC1-5,08	Vertical	ø 3 mm	2 (2 rows x 1 column)	5.08 mm
	2202312	HS LC-V-D3/ R3xC1-5,08	Vertical	ø 3 mm	3 (3 rows x 1 column)	5.08 mm
	2202313	HS LC-H-D3/ R1xC1	Horizontal	ø 3 mm	1 (1 row x 1 column)	
	2202314	HS LC-H-5x2/ R1xC1	Horizontal	5 x 2 mm	1 (1 row x 1 column)	
	2202315	HS LC-H-D3/ R2xC1-5,08	Horizontal	ø 3 mm	2 (2 rows x 1 column)	2.54 mm
	2202316	HS LC-H-D2/ R2xC1-2,54	Horizontal	ø 2 mm	2 (2 rows x 1 column)	2.54 mm
	2202317	HS LC-H-D2/ R2xC2-2,54	Horizontal	ø 2 mm	4 (2 rows x 2 columns)	2.54 mm
	2202318	HS LC-H-D2/ R2xC5-2,54	Horizontal	ø 2 mm	10 (2 rows x 5 columns)	2.54 mm
	2202319	HS LC-H-D2/ R2xC10-2,54	Horizontal	ø 2 mm	20 (2 rows x 10 columns)	2.54 mm
	2202320	HS LC-H-D2/ R4xC2-2,54	Horizontal	ø 2 mm	8 (4 rows x 2 columns)	2.54 mm
	2202321	HS LC-H-D2/ R4xC5-2,54	Horizontal	ø 2 mm	20 (4 rows x 5 columns)	2.54 mm
	2202322	HS LC-H-D2/ R4xC9-2,54	Horizontal	ø 2 mm	36 (4 rows x 9 columns)	2.54 mm
	2202323	HS LC-H-D2/ R4xC10-2,54	Horizontal	ø 2 mm	40 (4 rows x 10 columns)	2.54 mm



ESD protection	Material of the light guide	Ambient temperature	LED recommendations (manufacturer: Osram)	Recommended housing use
<12 kV	UL94 crystal clear PC	-40°C ... +85 °C	LS T670 LS T679 LS T676 LT T673 LY T670 LY T679 LO T676 LW T673 LG T670 LG T679 LY T676 LSG T670	BC 35,6 ... BC 161,6
<12 kV	UL94 crystal clear PC	-40°C ... +85 °C	LS T670 LS T679 LS T676 LT T673 LY T670 LY T679 LO T676 LW T673 LG T670 LG T679 LY T676 LSG T670	BC 35,6 ... BC 161,6
<12 kV	UL94 crystal clear PMMA	-40°C ... +85 °C	LS T670 LS T679 LS T676 LT T673 LY T670 LY T679 LO T676 LW T673 LG T670 LG T679 LY T676 LSG T670	BC 17,8. ME, ME MAX, ME-IO, ME-PLC, EH
<12 kV	UL94 crystal clear PMMA	-40°C ... +85 °C	LS T670 LS T679 LS T676 LT T673 LY T670 LY T679 LO T676 LW T673 LG T670 LG T679 LY T676 LSG T670	BC 17,8. ME, ME MAX, ME-IO, ME-PLC, EH
6.5 kV ... <12 kV	UL94 crystal clear PC	-40°C ... +85 °C	LS M670 LS M676 LY M676 LG M670 LO M676 LT M673	BC 17,8. ME, ME MAX, ME-IO, ME-PLC, EH
<8 kV	UL94 crystal clear PC	-40°C ... +85 °C	LG Q971 LS Q976 LY Q971 LY Q976 LO Q976	BC 17,8. ME, ME MAX, ME-IO, ME-PLC, EH
<8 kV	UL94 crystal clear PC	-40°C ... +85 °C	LG Q971 LS Q976 LY Q971 LY Q976 LO Q976	BC 17,8. ME, ME MAX, ME-IO, ME-PLC, EH
<8 kV	UL94 crystal clear PC	-40°C ... +85 °C	LG Q971 LS Q976 LY Q971 LY Q976 LO Q976	BC 17,8. ME, ME MAX, ME-IO, ME-PLC, EH
<8 kV	UL94 crystal clear PC	-40°C ... +85 °C	LG Q971 LS Q976 LY Q971 LY Q976 LO Q976	BC 17,8. ME, ME MAX, ME-IO, ME-PLC, EH
<8 kV	UL94 crystal clear PC	-40°C ... +85 °C	LG Q971 LS Q976 LY Q971 LY Q976 LO Q976	BC 17,8. ME, ME MAX, ME-IO, ME-PLC, EH
<8 kV	UL94 crystal clear PC	-40°C ... +85 °C	LG Q971 LS Q976 LY Q971 LY Q976 LO Q976	BC 17,8. ME, ME MAX, ME-IO, ME-PLC, EH
<8 kV	UL94 crystal clear PC	-40°C ... +85 °C	LG Q971 LS Q976 LY Q971 LY Q976 LO Q976	BC 17,8. ME, ME MAX, ME-IO, ME-PLC, EH
<8 kV	UL94 crystal clear PC	-40°C ... +85 °C	LG Q971 LS Q976 LY Q971 LY Q976 LO Q976	BC 17,8. ME, ME MAX, ME-IO, ME-PLC, EH

Customer-specific electronics housings

Phoenix Contact creates customized housings with matching connection technology for you, regardless of whether you use a screw or spring connection. We offer professional support, from the modification of a standard product all the way to a completely new development.



Your options



Many color versions

Electronics housings can also be produced in colors other than the standard color, either completely or as a combination of different colored housing parts. Our ability to reproduce your own company color maximizes the brand recognition factor.



Mechanical processing

State-of-the-art milling machines can create customer-specific machined holes on each side of the housing. This eliminates additional production steps and related logistical procedures for you. Your storage requirements are limited to the installed components.

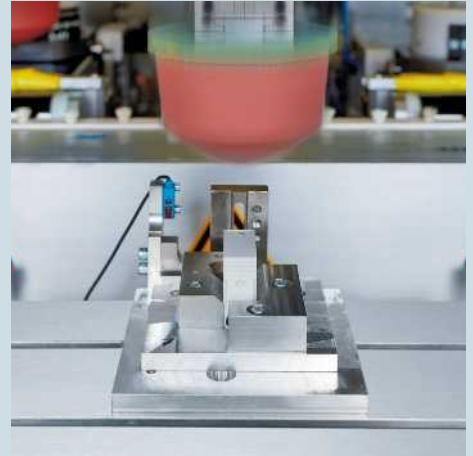

Customized printing and marking

- Pad printing: ideal for single- or two-color printing
- Screen printing: for printing in multiple colors on larger surfaces
- Laser marking: ideal for contents that change periodically such as serial numbers



Tool modification

For large volumes, injection molding is often a more cost-effective approach than mechanical finishing. We offer you the option of producing customized housing components directly from an original mold.



New components

To deliver a solution tailored to your specific requirements, it is sometimes necessary to replace individual standard housing parts with customer-specific designs. We design housing parts according to your specifications and combine them with proven standard components.



Customized new developments

Do you need a new, special housing designed according to your requirements? With the expertise of an experienced housing specialist, we will support and assist you through all the necessary steps.



Always up-to-date, always available to you. Here you'll find everything on our products, solutions and service:

phoenixcontact.com

Product range

- Cables and wires
- Connectors
- Controllers
- Electronics housings
- Electronic switchgear and motor control
- Fieldbus components and systems
- Functional safety
- HMIs and industrial PCs
- I/O systems
- Industrial communication technology
- Industrial Ethernet
- Installation and mounting material
- Lighting and signaling
- Marking and labeling
- Measurement and control technology
- Modular terminal blocks
- Monitoring
- PCB terminal blocks and PCB connectors
- Power supply units and UPS
- Protective devices
- Relay modules
- Sensor/actuator cabling
- Software
- Surge protection and interference filters
- System cabling for controllers
- Tools
- Wireless data communication

PHOENIX CONTACT GmbH & Co. KG
Flachmarktstraße 8
32825 Blomberg, Germany
Phone: + 49 5235 3-00
Fax: + 49 5235 3-41200
E-mail: info@phoenixcontact.com
phoenixcontact.com