

Table of Contents

TECHNICAL NOTES

51

SMD Tape Specifications

Recommended Soldering Pattern

Technical Data

Bin Code Systems

Application Notes

Index

SMD TAPE SPECIFICATIONS

Reel Dimensions	Part Number	Reel Dimensions	Part Number	Reel Dimensions	Part Number	Reel Dimensions	Part Number
7" (for 8mm width tape) (black)	KP-1608 KPG-0603 KPG-1005 KPG-1608 KPGF-1011 KPH-1608 KPHB-1608 KPHHS-1005 KPHM-1608 KPT-1608 KPTB-1612 KPTD-1608	7" (for 8mm width tape) (white)	KA-2810A KA-3021 KM-23-F KM-23XXX KP-2012 KP-3216 KPA-1606 KPA-2107 KPA-3010 KPB-3025 KPBA-3010 KPBD-3224 KPBDA-3020-PF KPBL-3025 KPD-3224 KPFA-2507 KPFA-3010 KPGA-1602 KPHBM-2012 KPHCM-2012 KPL-3015	7" (for 12mm width tape)	KPT-2012 KPT-3216 KPTB-1615 KPTBD-3216 KPTD-3216 KPTF-1616 KPTL-3216 KPTR-3216	13" (for 24mm width tape)	KCDX02 KCDX03 KCSX02 KCSX03 KCSX04
						13" (for 32mm width tape)	KCDX04 KCPDX04 KCSX04 KCSX39 KCSX56
						13" (for 44mm width tape)	KCDX56

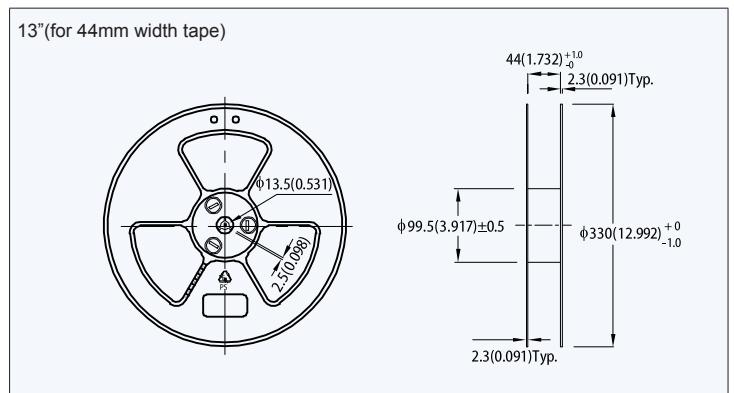
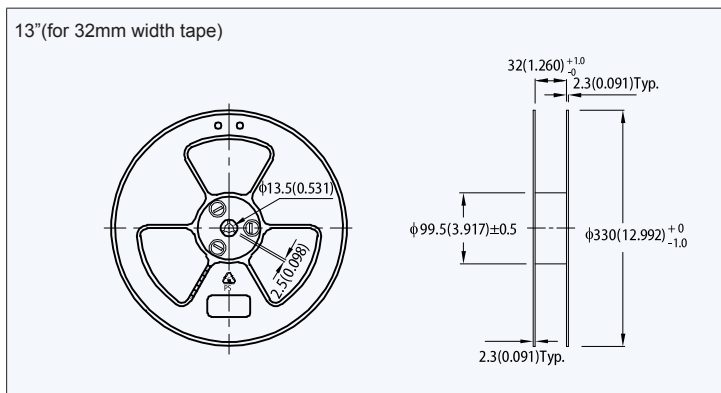
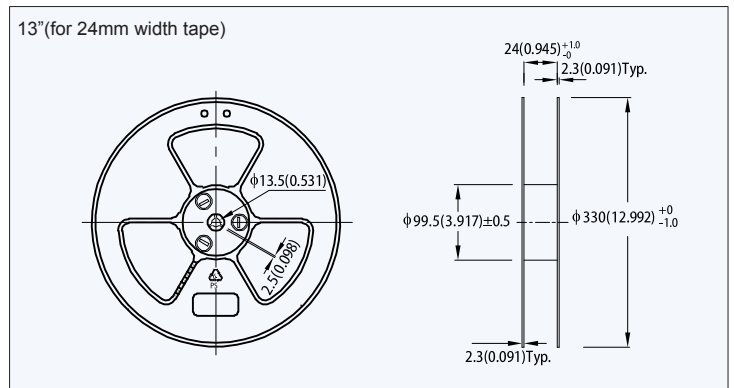
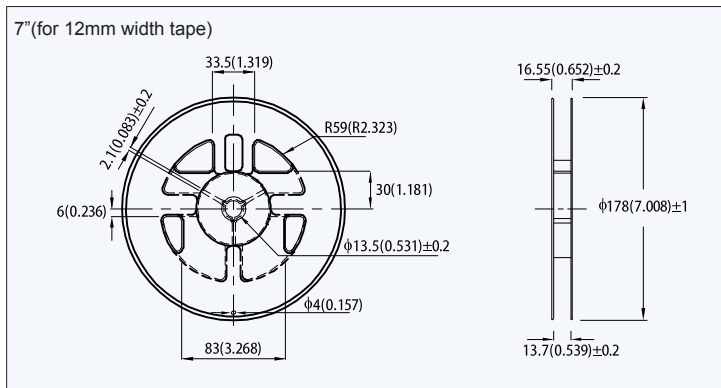
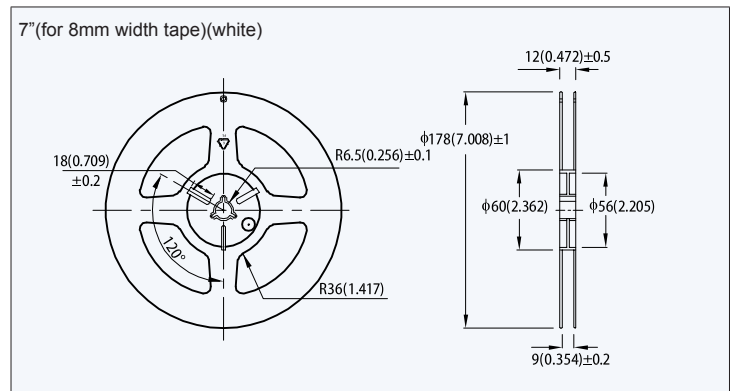
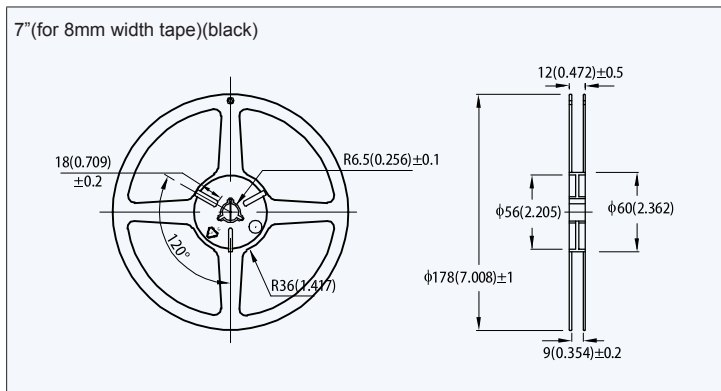

NOTE: 1. All dimensions are in millimeters(inches).

SMD TAPE SPECIFICATIONS

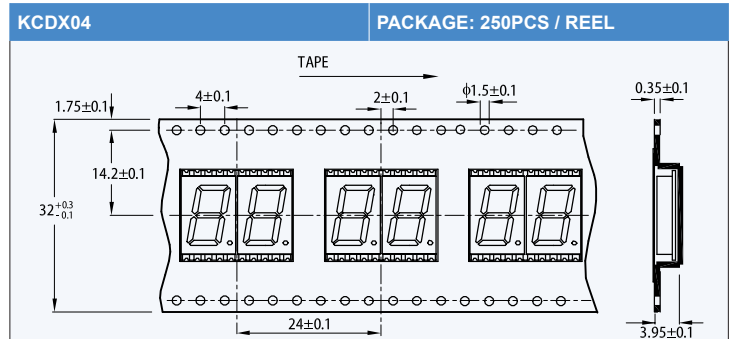
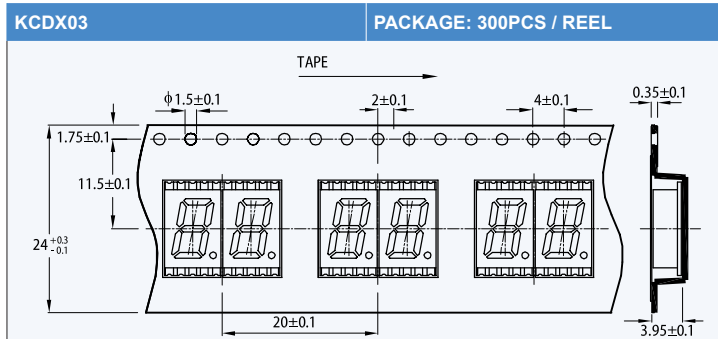
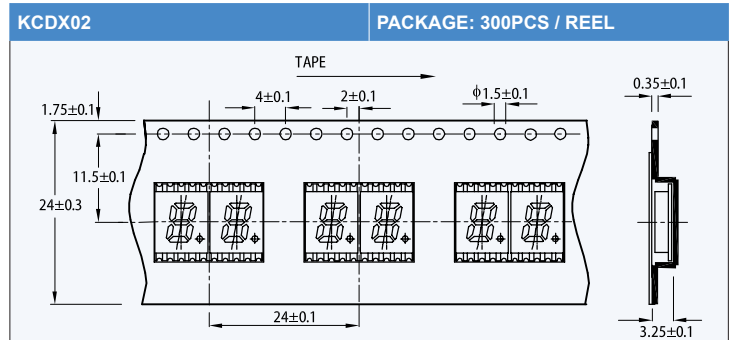
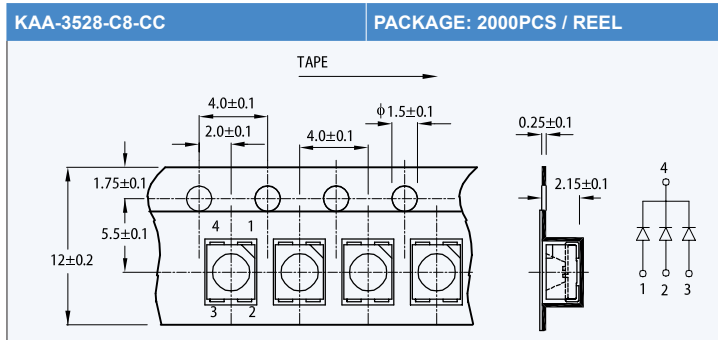
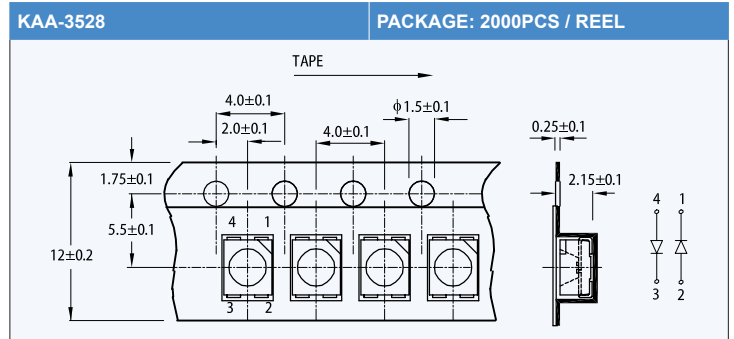
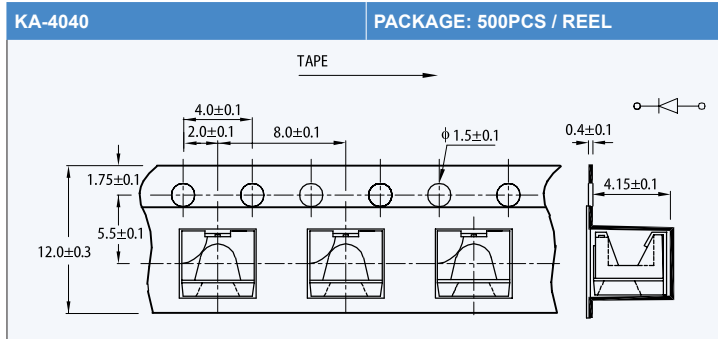
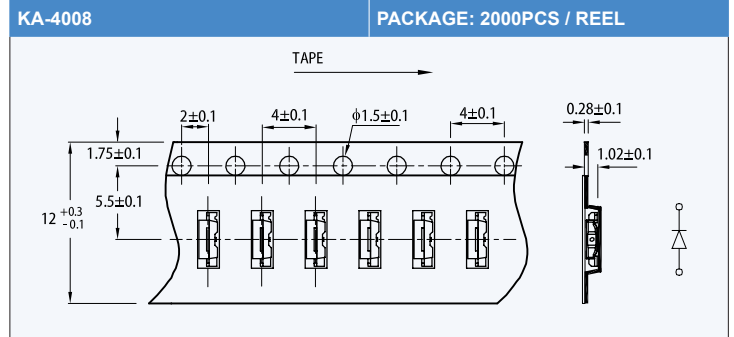
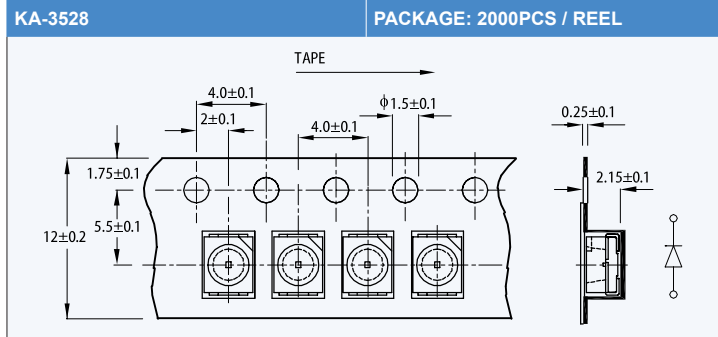
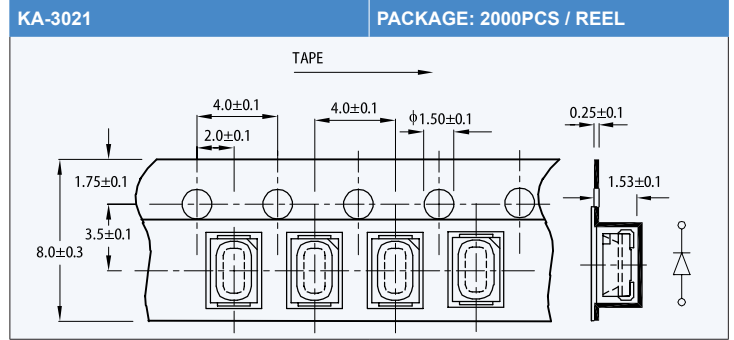
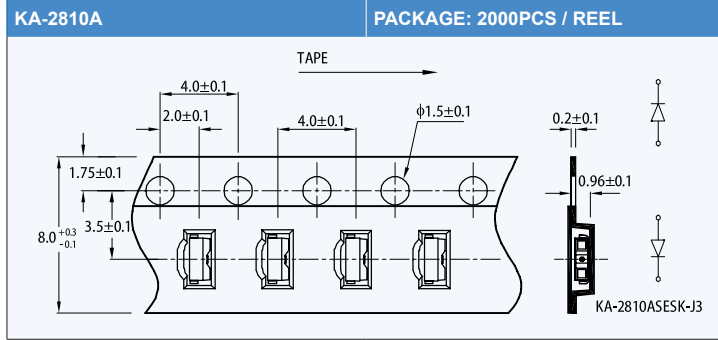

NOTE: 1. All dimensions are in millimeters.

SMD TAPE SPECIFICATIONS

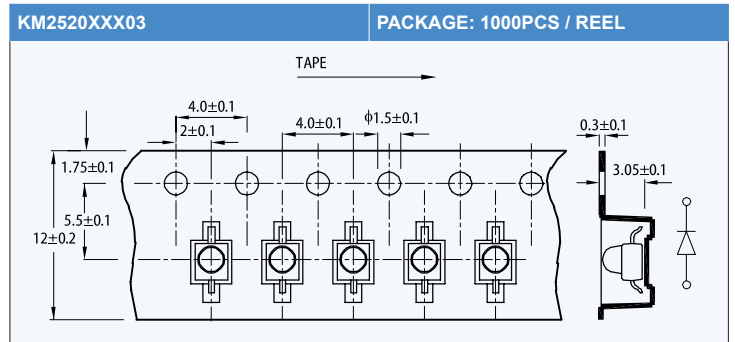
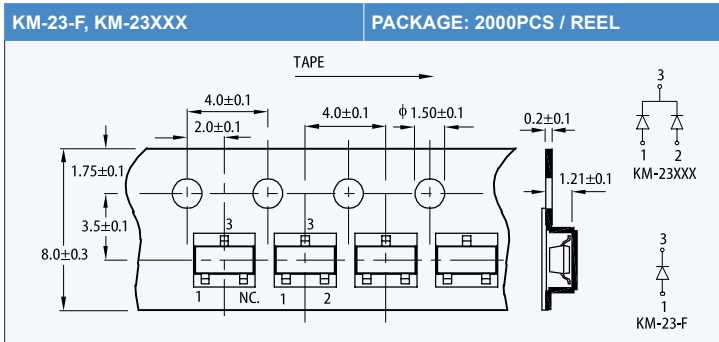
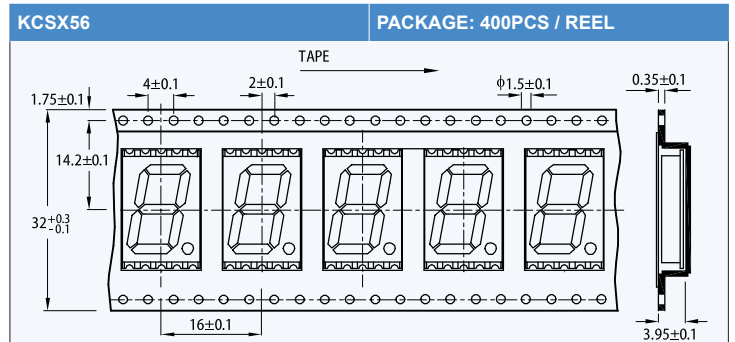
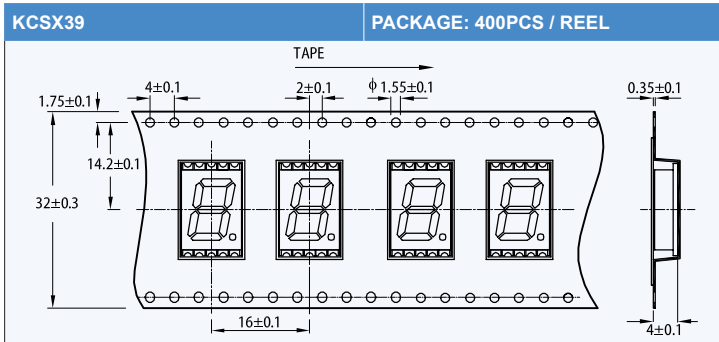
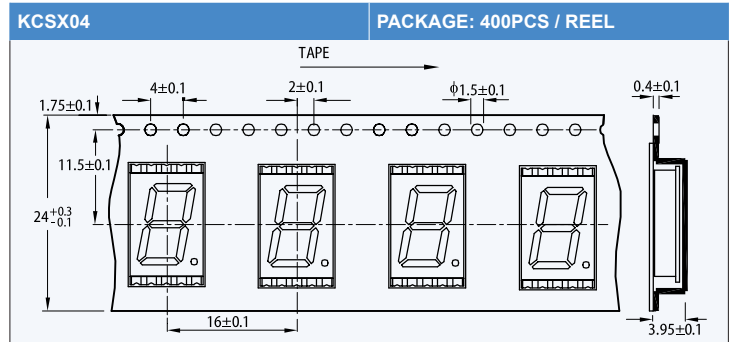
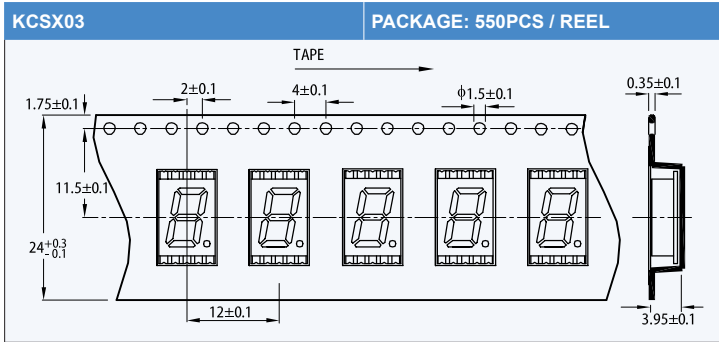
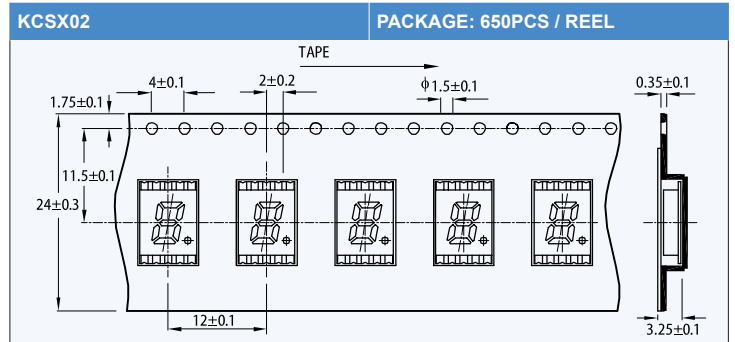
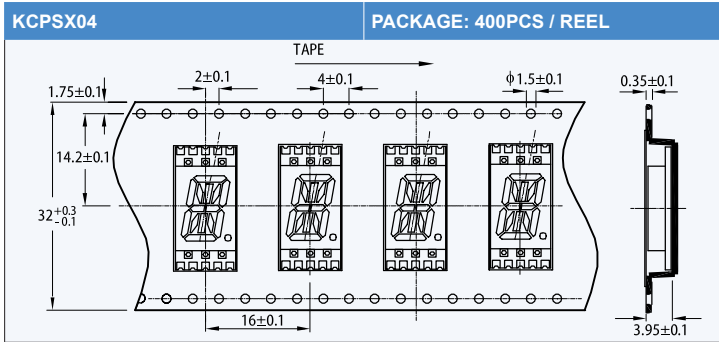
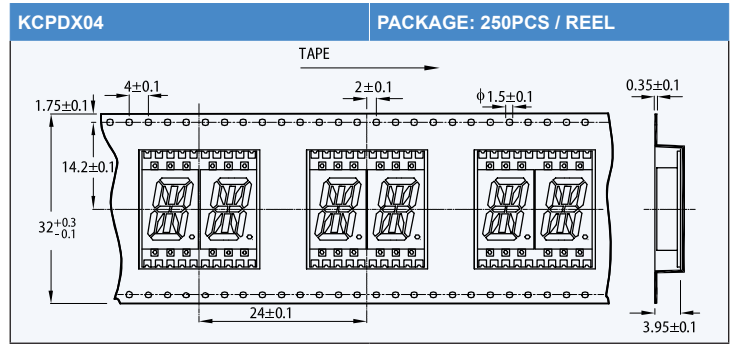
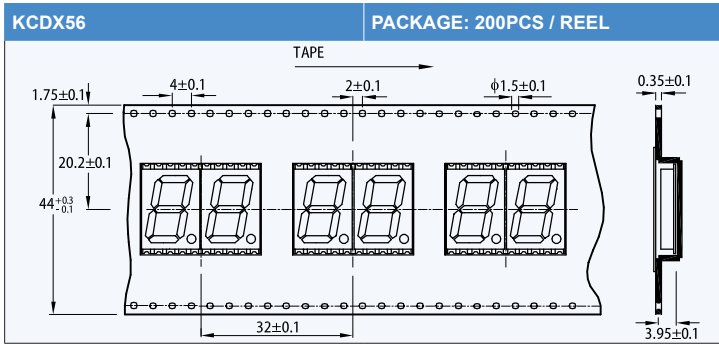

NOTE: 1. All dimensions are in millimeters.

SMD TAPE SPECIFICATIONS

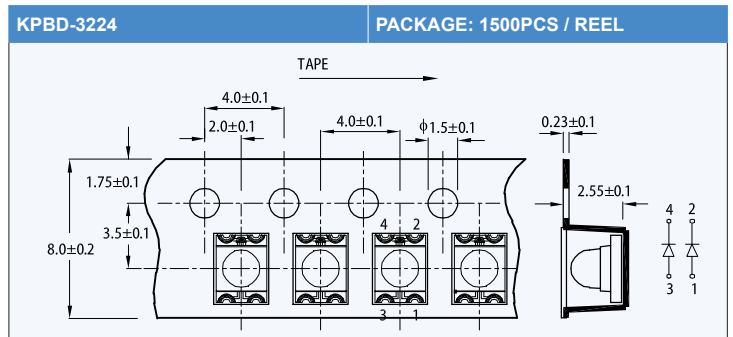
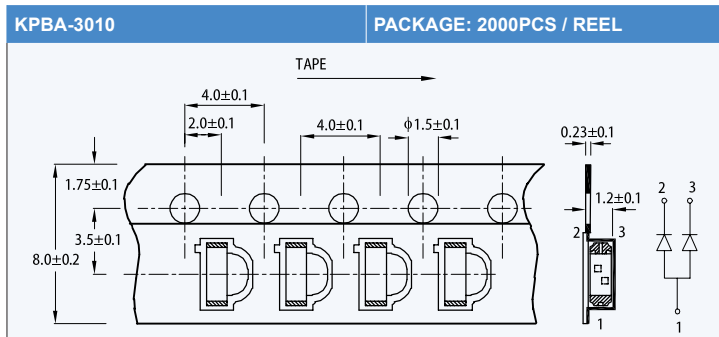
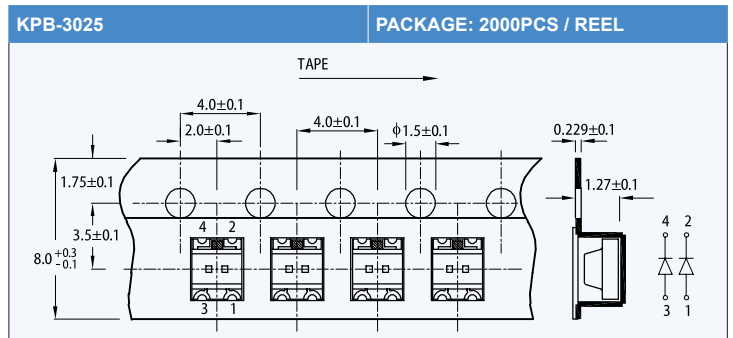
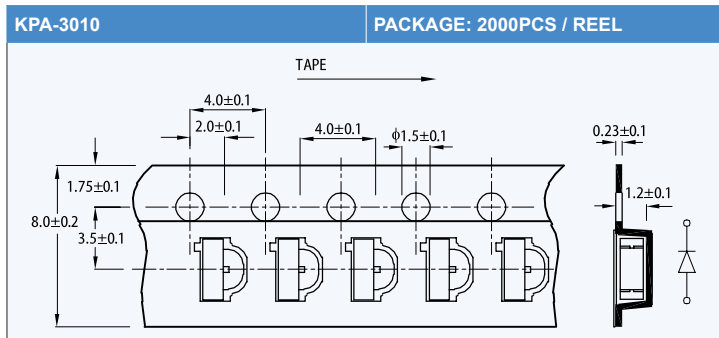
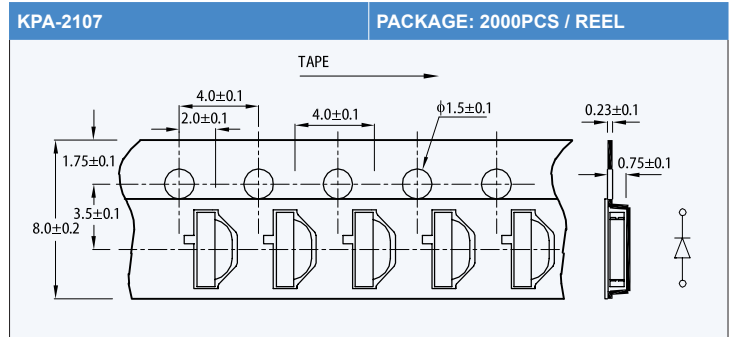
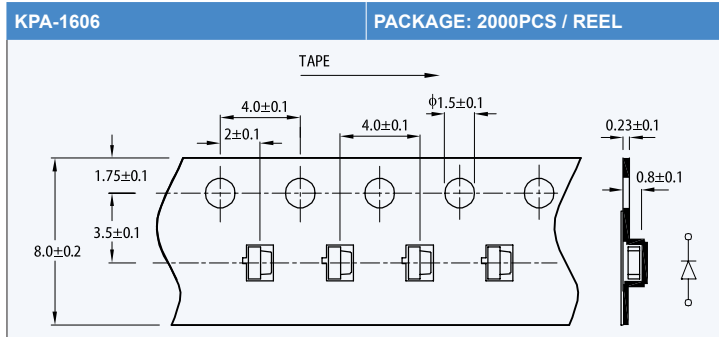
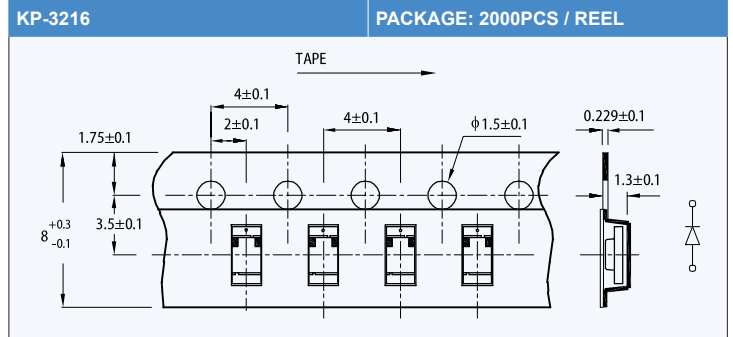
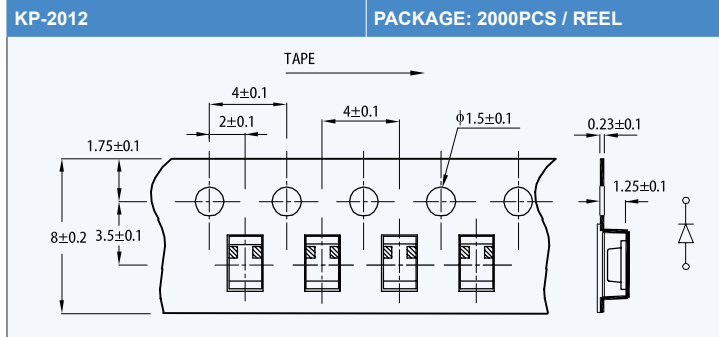
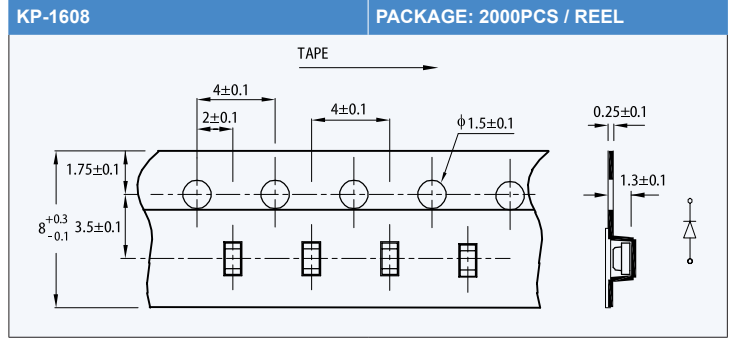
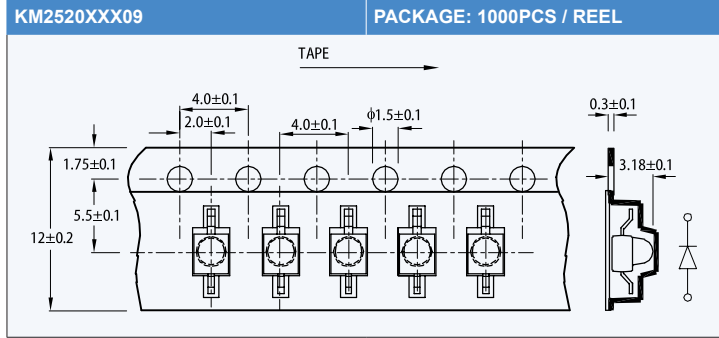

NOTE: 1. All dimensions are in millimeters.

SMD TAPE SPECIFICATIONS

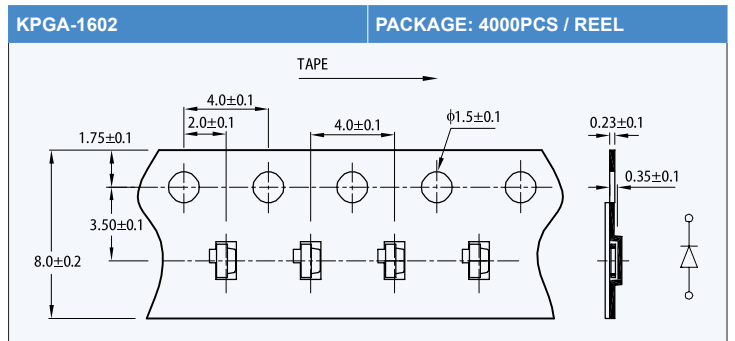
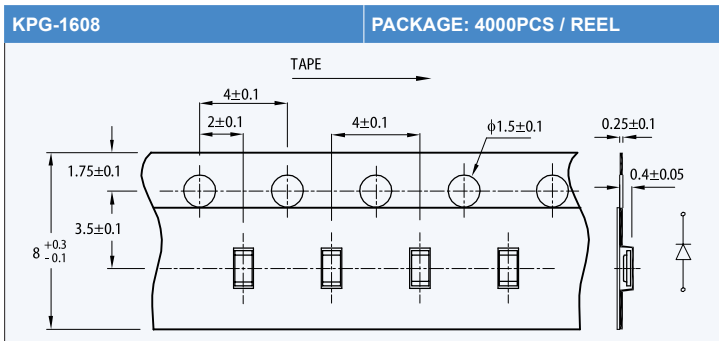
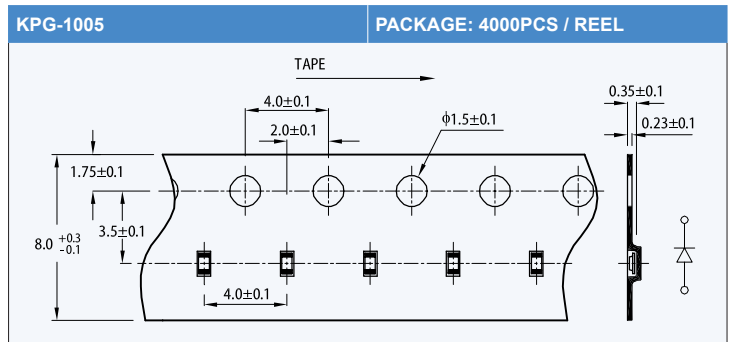
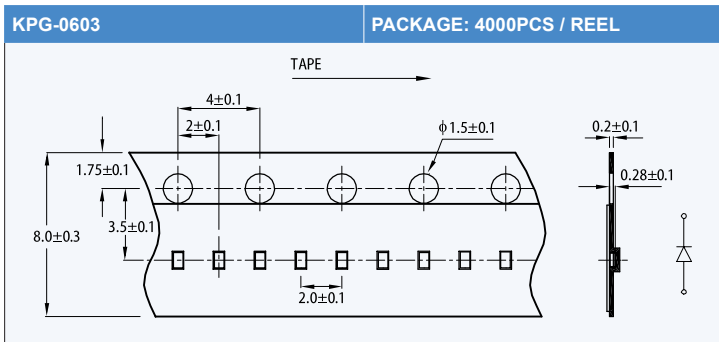
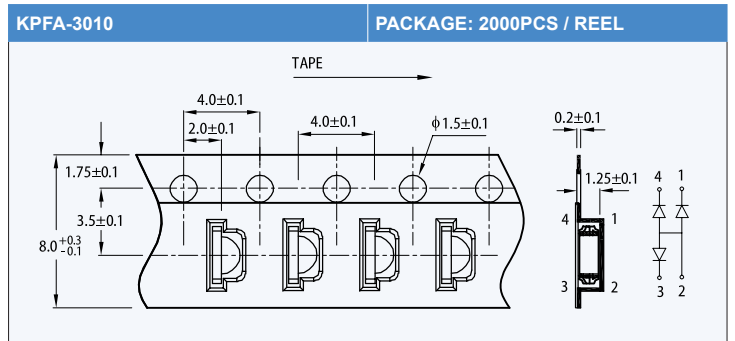
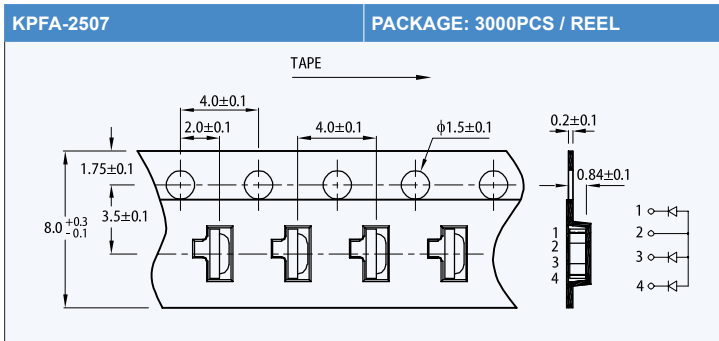
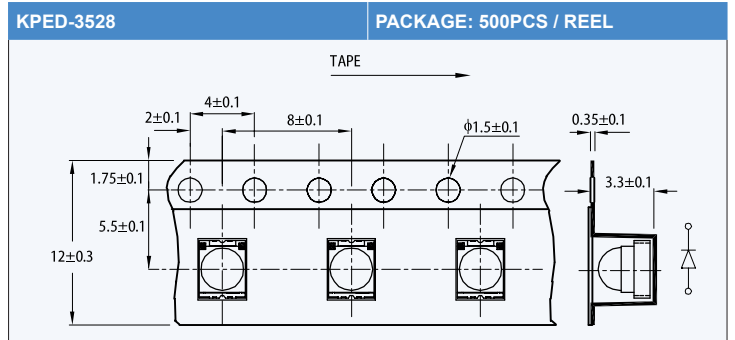
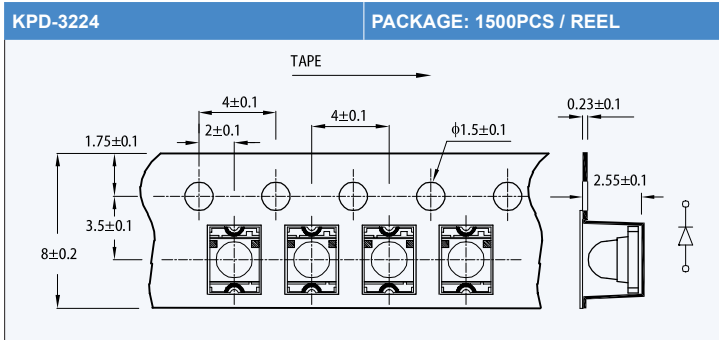
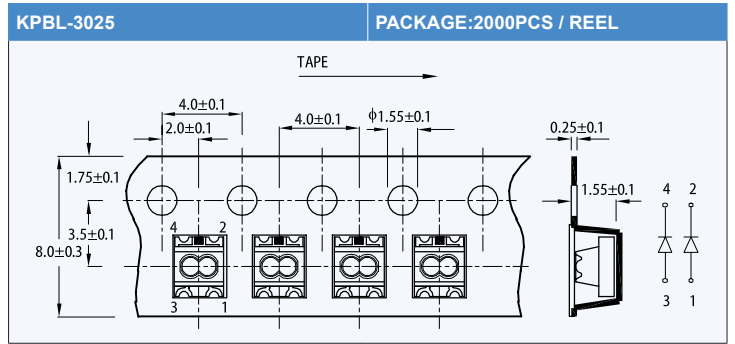
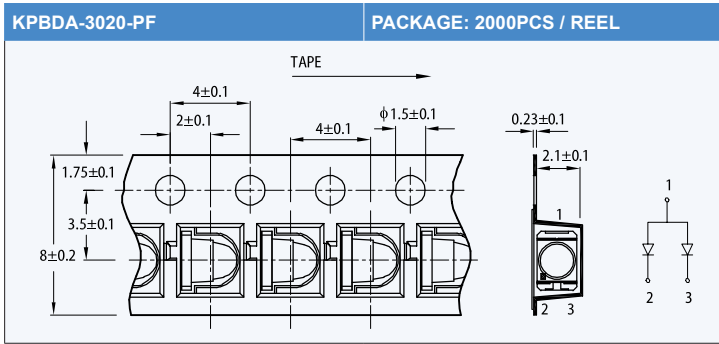

NOTE: 1. All dimensions are in millimeters.

SMD TAPE SPECIFICATIONS

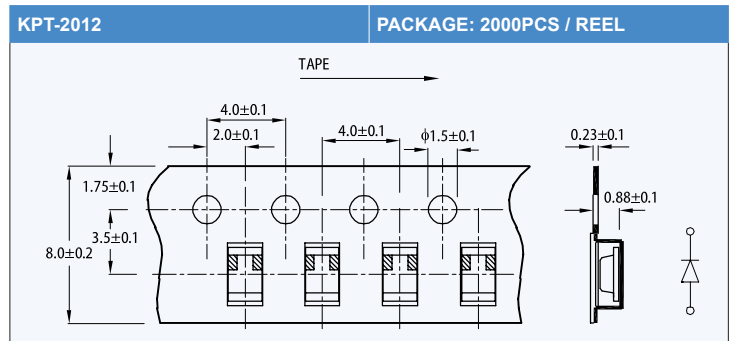
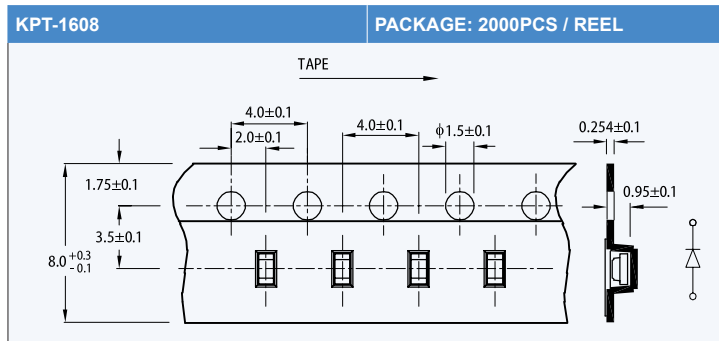
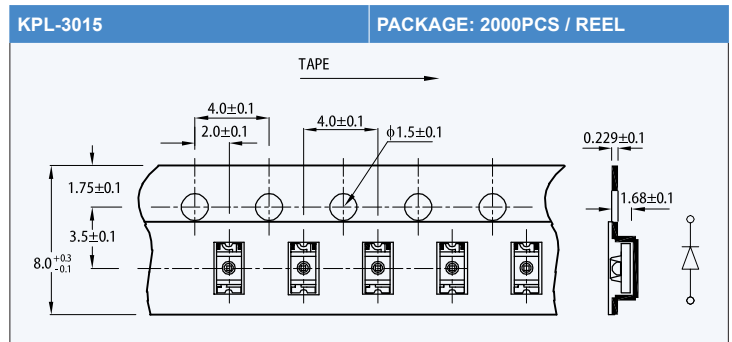
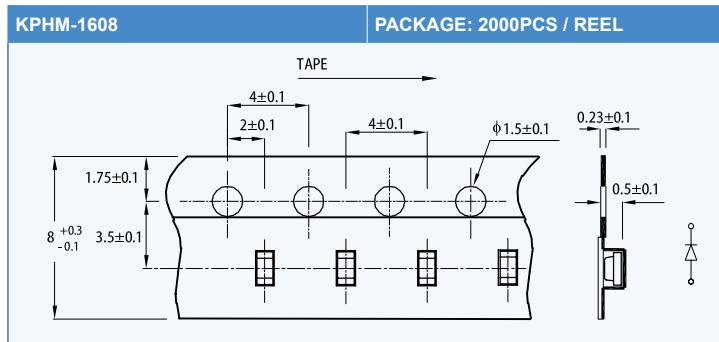
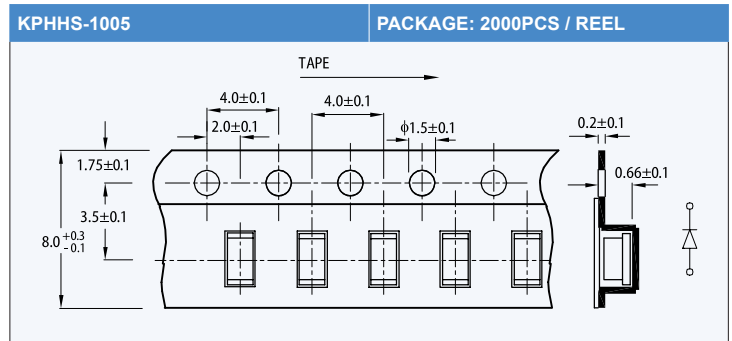
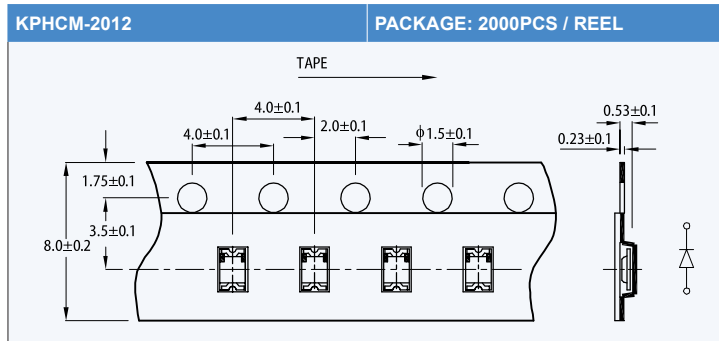
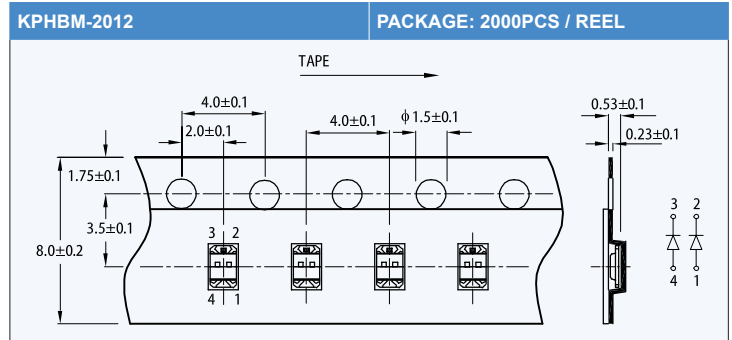
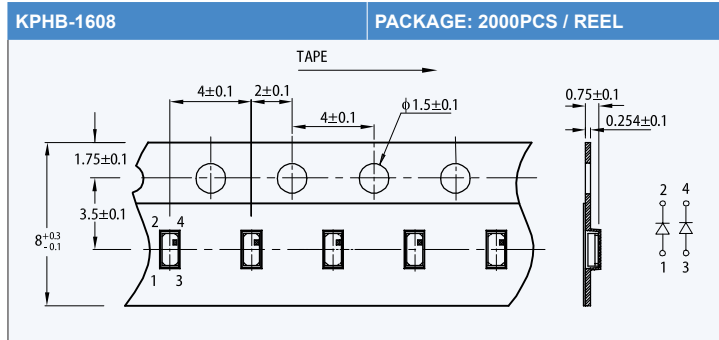
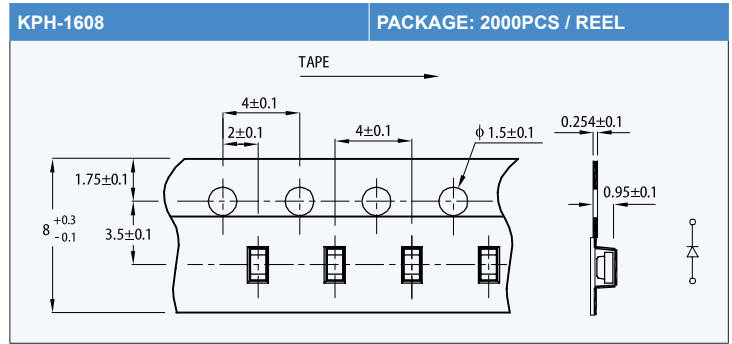
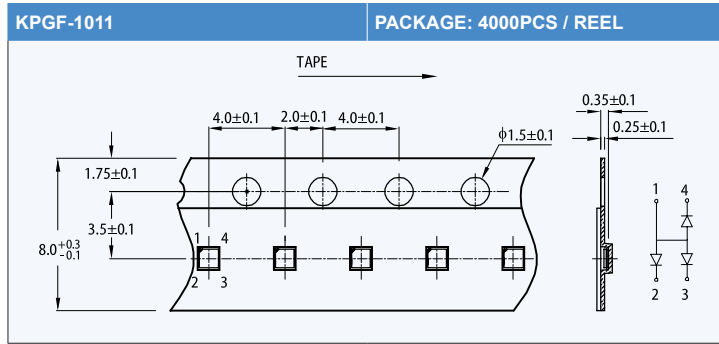

NOTE: 1. All dimensions are in millimeters.

SMD TAPE SPECIFICATIONS

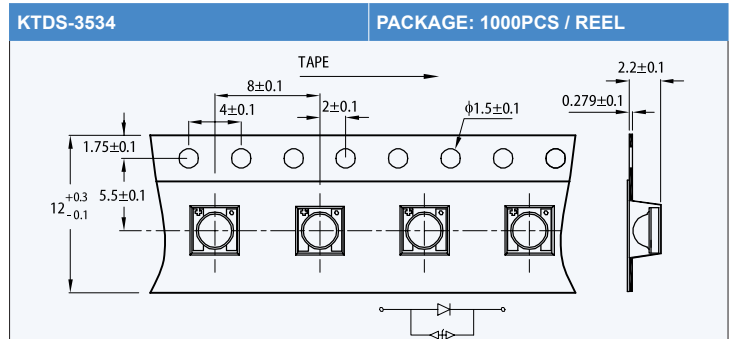
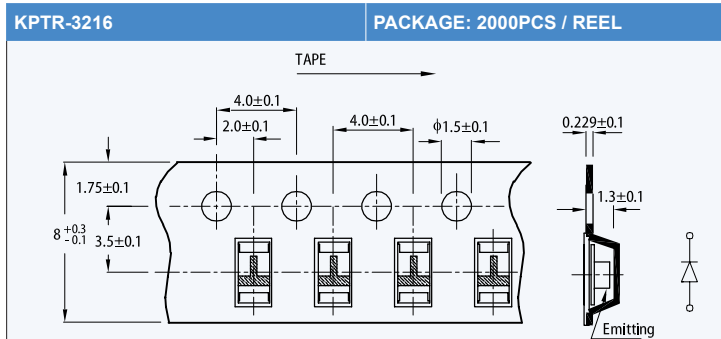
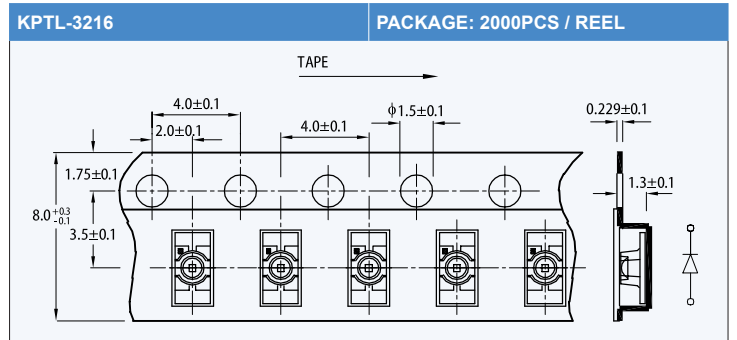
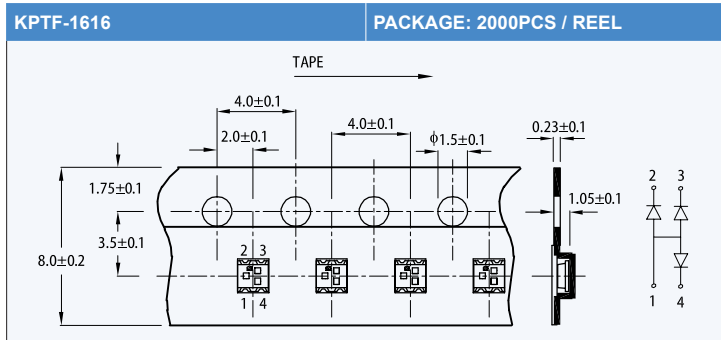
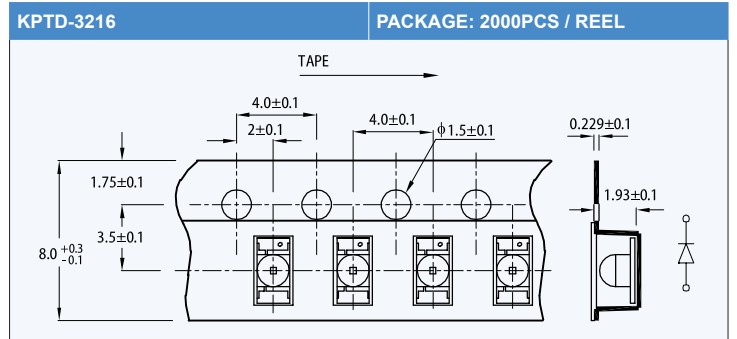
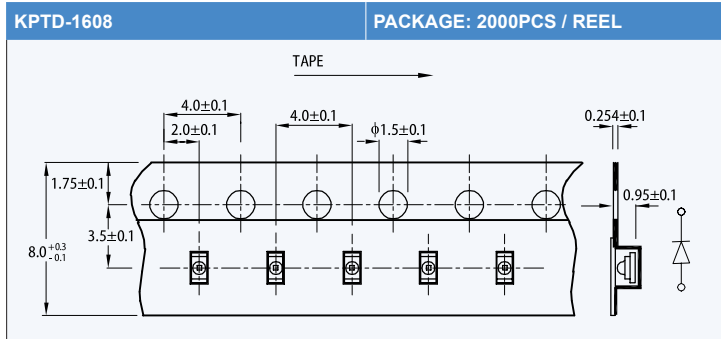
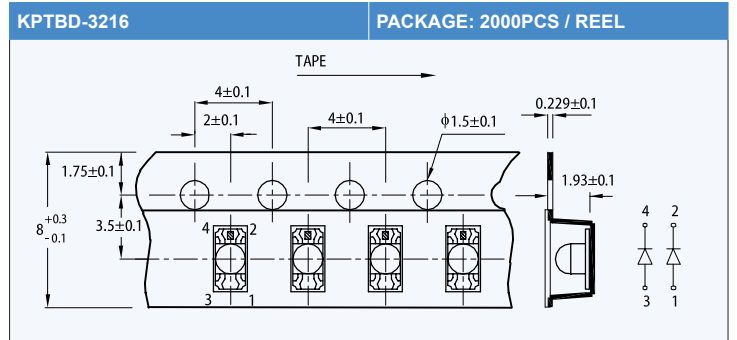
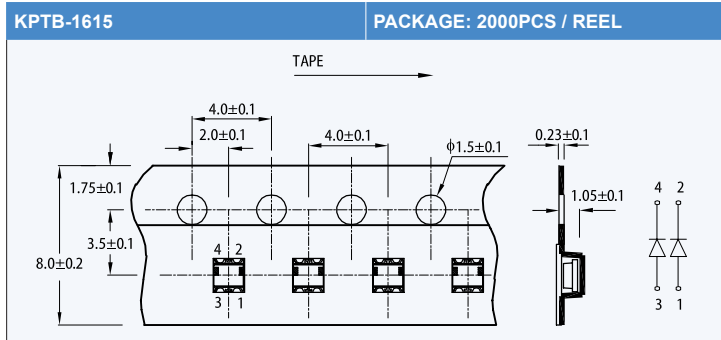
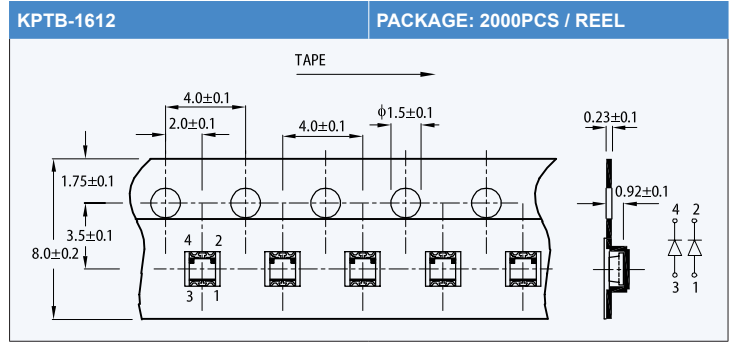
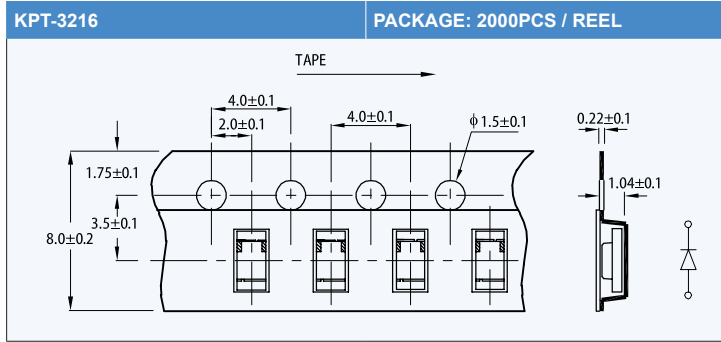

NOTE: 1. All dimensions are in millimeters.

SMD TAPE SPECIFICATIONS

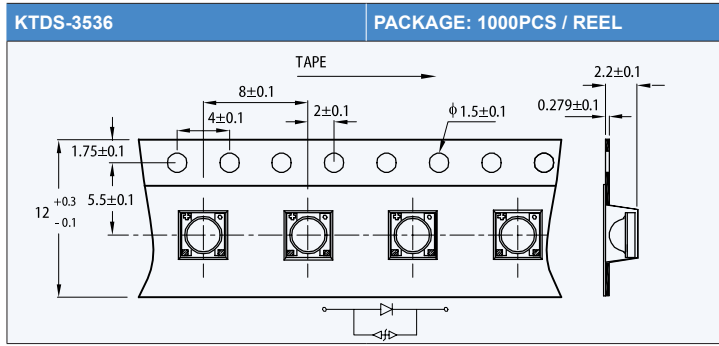

RECOMMENDED SOLDERING PATTERN

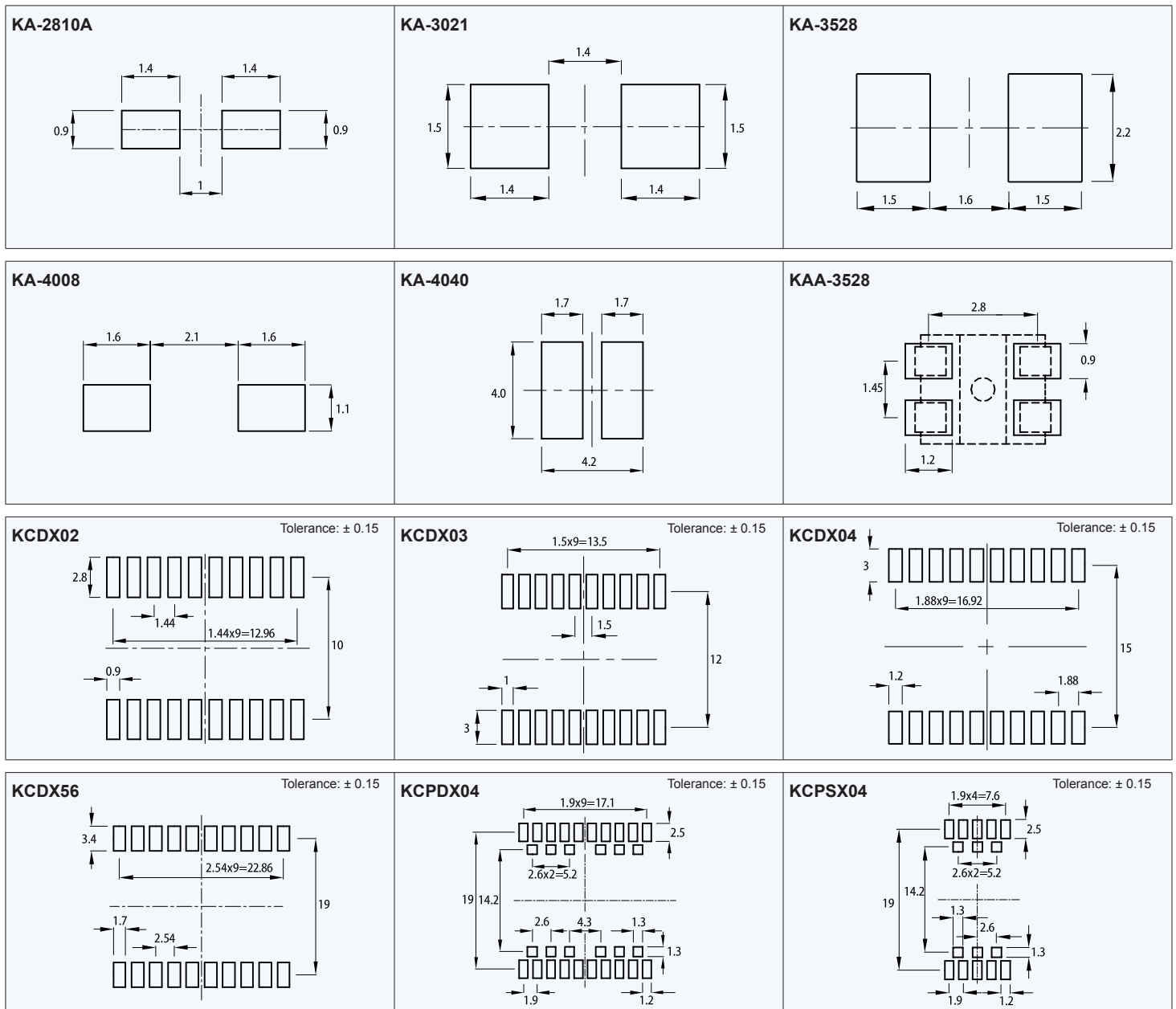

NOTE: 1. All dimensions are in millimeters.

RECOMMENDED SOLDERING PATTERN

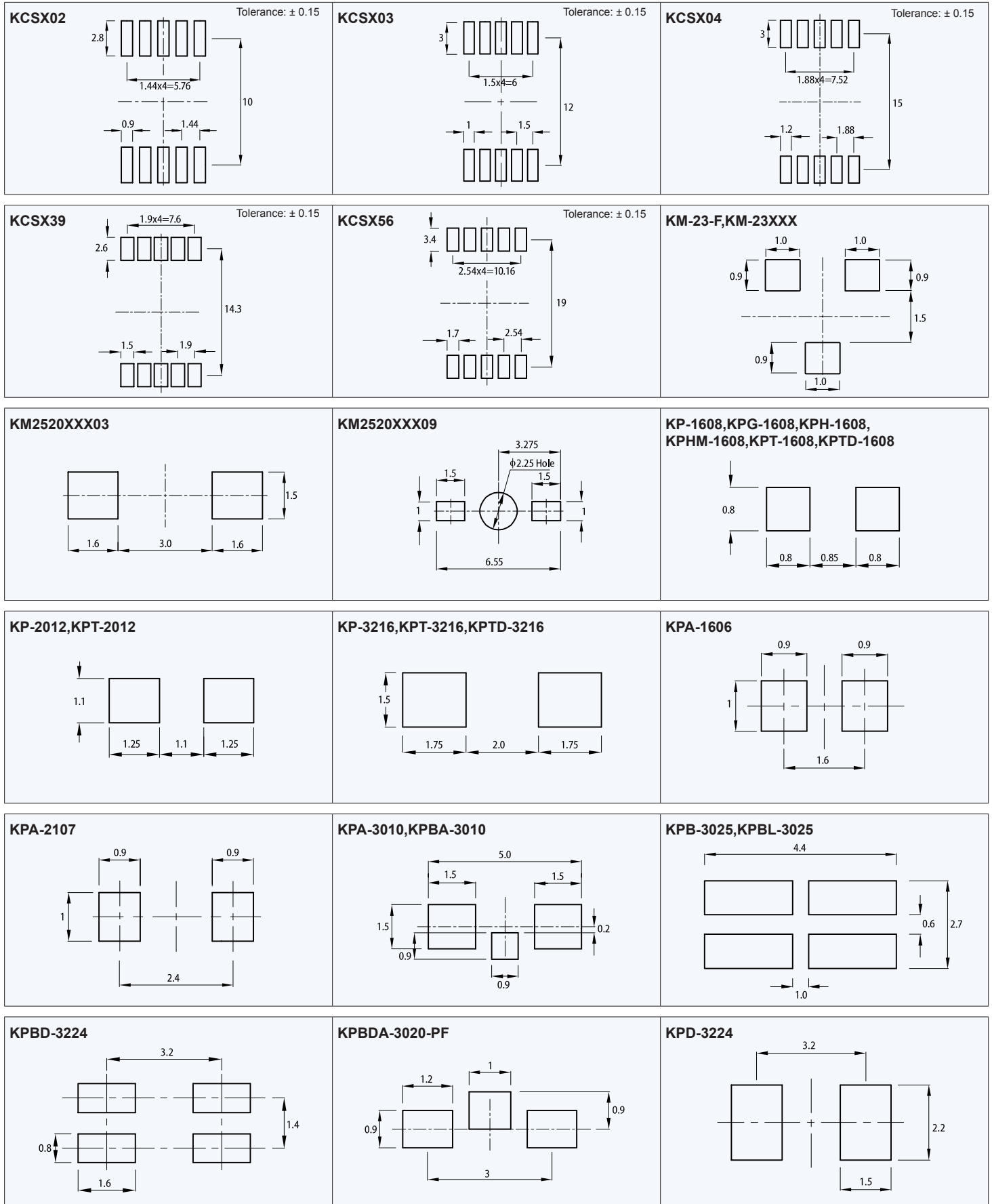

NOTES:
 1. All dimensions are in millimeters.
 2. Tolerance is $\pm 0.1\text{mm}$ unless otherwise noted.

RECOMMENDED SOLDERING PATTERN

<p>KPED-3528</p>	<p>KPFA-2507</p>	<p>KPFA-3010</p>
<p>KPG-0603</p>	<p>KPG-1005, KPHHS-1005</p>	<p>KPGA-1602</p>
<p>KPGF-1011</p>	<p>KPHB-1608</p>	<p>KPHBM-2012</p>
<p>KPHCM-2012</p>	<p>KPL-3015</p>	<p>KPTB-1612</p>
<p>KPTB-1615, KPTF-1616</p>	<p>KPTBD-3216</p>	<p>KPTL-3216</p>
<p>KPTR-3216</p>	<p>KTDS-3534, KTDS-3536</p>	

- NOTES:
 1. All dimensions are in millimeters.
 2. Tolerance is ± 0.1 mm unless otherwise noted.

TECHNICAL DATA

Absolute maximum ratings (T _A =25°C)		E, I Hi.Eff.Red Orange (GaAsP/GaP)	H Bright Red (GaP)	SR Super Bright Red (GaAlAs)	SR-J4 Super Bright Red (AlGaInP)	SURK Hyper Red (AlGaInP)	SURK-T Hyper Red (AlGaInP)	SUR-E Hyper Red (AlGaInP)	Unit
Reverse voltage	V _R	●	●	●	●	●	●	●	V
Forward current	I _F	5	5	5	5	5	5	5	mA
Forward current (Peak) 1/10 Duty Cycle, 0.1ms Pulse Width	i _{FS}	30	25	30	30	30	30	30	mA
Power dissipation	P _D	160	130	155	150	185	150	200	mW
LED LAMPS:									
Operating temperature	T _A	75	62.5	75	75	75	75	75	°C
Storage temperature	T _{STG}	-40~+85	-40~+85	-40~+85	-40~+85	-40~+85	-40~+85	-40~+85	°C
LED DISPLAYS:									
Operating temperature	T _A	-40~+85	-40~+85	-40~+85	-40~+85	-40~+85	-40~+85	-40~+85	°C
Storage temperature	T _{STG}	-40~+85	-40~+85	-40~+85	-40~+85	-40~+85	-40~+85	-40~+85	°C

Operating Characteristics		E, I Hi.Eff.Red Orange (GaAsP/GaP)	H Bright Red (GaP)	SR Super Bright Red (GaAlAs)	SR-J4 Super Bright Red (AlGaInP)	SURK Hyper Red (AlGaInP)	SURK-T Hyper Red (AlGaInP)	SUR-E Hyper Red (AlGaInP)	Unit
Forward voltage (typ.) I _F =20mA	V _F	●	●	●	●	●	●	●	V
I _F =10mA		2.0	2.25	1.85	2.1	1.95	2.0	1.9	
I _F =2mA		1.9	2.05	1.8	1.8	1.85	1.85	1.8	
Forward voltage (max.) I _F =20mA	V _F	1.7	1.85	1.65	1.65	1.75	1.75	1.7	V
I _F =10mA		2.5	2.5	2.5	2.5	2.5	2.5	2.5	
I _F =2mA		2.3	2.45	2.3	2.3	2.35	2.25	2.35	
Reverse current V _R =5V	I _R	2.1	2.25	2.1	2.1	2.2	2.15	2.2	uA
Peak Emission Wavelength I _F =20mA, 10mA, 2mA	λ _p	10	10	10	10	10	10	10	nm
Dominant Wavelength I _F =20mA, 10mA, 2mA	λ _D	627	700	655	660	645	645	645	nm
Spectral line half-width I _F =20mA, 10mA, 2mA	Δλ _{1/2}	617	635	640	640	630	630	630	nm
Capacitance V _F =0V, f=1MHZ	C	45	45	20	20	28	20	25	nm
		15	40	45	45	35	35	45	pF

TECHNICAL DATA

Absolute maximum ratings (T _A =25°C)		SEK-J3 Hyper Red	SE-J3 Hyper Red	SE-E Hyper Red	SE-H Hyper Red	SEK-J4 Super Bright Orange	N Pure Orange	SEK Super Bright Orange	Unit
		(AlGaInP)	(AlGaInP)	(AlGaInP)	(AlGaInP)	(AlGaInP)	(GaAsP/GaP)	(AlGaInP)	
Reverse voltage	V _R	5	5	5	5	5	5	5	V
Forward current	I _F	30	30	30	30	30	25	30	mA
Forward current (Peak) 1/10 Duty Cycle, 0.1ms Pulse Width	I _{FS}	150	150	195	150	150	145	195	mA
Power dissipation	P _D	84	84	75	84	84	62.5	75	mW
LED LAMPS:									
Operating temperature	T _A	-40~+85	-40~+85	-40~+85	-40~+85	-40~+85	-40~+85	-40~+85	°C
Storage temperature	T _{STG}	-40~+85	-40~+85	-40~+85	-40~+85	-40~+85	-40~+85	-40~+85	°C
LED DISPLAYS:									
Operating temperature	T _A	-40~+85	-40~+85	-40~+85	-40~+85	-40~+85	-40~+85	-40~+85	°C
Storage temperature	T _{STG}	-40~+85	-40~+85	-40~+85	-40~+85	-40~+85	-40~+85	-40~+85	°C

Operating Characteristics		SEK-J3 Hyper Red	SE-J3 Hyper Red	SE-E Hyper Red	SE-H Hyper Red	SEK-J4 Super Bright Orange	N Pure Orange	SEK Super Bright Orange	Unit
		(AlGaInP)	(AlGaInP)	(AlGaInP)	(AlGaInP)	(AlGaInP)	(GaAsP/GaP)	(AlGaInP)	
Forward voltage (typ.) I _F =20mA	V _F	2.2	2.2	2.0	2.2	2.2	2.05	2.1	V
I _F =10mA		2.0	2.0	1.9	2.05	2.0	1.95	2.0	
I _F =2mA		1.8	1.8	1.8	1.85	1.8	1.85	1.85	
Forward voltage (max.) I _F =20mA	V _F	2.8	2.8	2.5	2.8	2.8	2.5	2.5	V
I _F =10mA		2.3	2.3	2.3	2.4	2.4	2.3	2.35	
I _F =2mA		2.15	2.15	2.1	2.2	2.2	2.1	2.2	
Reverse current V _R =5V	I _R	10	10	10	10	10	10	10	µA
Peak Emission Wavelength I _F =20mA, 10mA, 2mA	λ _P	640	640	630	635	611	607	610	nm
Dominant Wavelength I _F =20mA, 10mA, 2mA	λ _D	625	625	621	625	605	602	605	nm
Spectral line half-width I _F =20mA, 10mA, 2mA	Δλ _{1/2}	20	25	20	25	17	35	29	nm
Capacitance V _F =0V, f=1MHZ	C	27	27	25	27	27	15	15	pF

TECHNICAL DATA

Absolute maximum ratings (T _A =25°C)		SEK-T Super Bright Orange	G,SG Green, Super Bright Green	CG-KA Green	CGK Green	CGK-T Green	ZGK Green	ZG Green	Unit
		(AlGaInP)	(GaP)	(AlGaInP)	(AlGaInP)	(AlGaInP)	(InGaN)	(InGaN)	
Reverse voltage	V _R	5	5	5	5	5	5	5	V
Forward current	I _F	30	25	20	30	30	25	25	mA
Forward current (Peak) 1/10 Duty Cycle, 0.1ms Pulse Width	i _{FS}	150	140	100	150	150	150	150	mA
Power dissipation	P _D	75	62.5	48	75	78	102.5	102.5	mW
LED LAMPS:									
Operating temperature	T _A	-40~+85	-40~+85	-40~+85	-40~+85	-40~+85	-40~+85	-40~+85	°C
Storage temperature	T _{STG}	-40~+85	-40~+85	-40~+85	-40~+85	-40~+85	-40~+85	-40~+85	°C
LED DISPLAYS:									
Operating temperature	T _A	-40~+85	-40~+85	-40~+85	-40~+85	-40~+85	-40~+85	-40~+85	°C
Storage temperature	T _{STG}	-40~+85	-40~+85	-40~+85	-40~+85	-40~+85	-40~+85	-40~+85	°C

Operating Characteristics		SEK-T Super Bright Orange	G,SG Green, Super Bright Green	CG-KA Green	CGK Green	CGK-T Green	ZGK Green	ZG Green	Unit
		(AlGaInP)	(GaP)	(AlGaInP)	(AlGaInP)	(AlGaInP)	(InGaN)	(InGaN)	
Forward voltage (typ.) I _F =20mA	V _F	2.05	2.2	2.05	2.1	2.1	3.3	3.3	V
I _F =10mA		1.95	2.0	2.0	2.0	1.95	3.0	3.0	
I _F =2mA		1.8	1.9	1.92	1.9	1.8	2.65	2.65	
Forward voltage (max.) I _F =20mA	V _F	2.5	2.5	2.4	2.5	2.6	4.1	4.1	V
I _F =10mA		2.3	2.4	2.35	2.45	2.4	3.4	3.4	
I _F =2mA		2.2	2.25	2.25	2.3	2.3	3.1	3.1	
Reverse current V _R =5V	I _R	10	10	10	10	10	50	50	uA
Peak Emission Wavelength I _F =20mA, 10mA, 2mA	λ _p	610	565	573	574	574	515	515	nm
Dominant Wavelength I _F =20mA, 10mA, 2mA	λ _D	601	568	571	570	570	525	525	nm
Spectral line half-width I _F =20mA, 10mA, 2mA	Δλ _{1/2}	17	30	15	20	15	35	30	nm
Capacitance V _F =0V, f=1MHZ	C	15	15	15	15	15	45	45	pF

TECHNICAL DATA

Absolute maximum ratings (T _A =25°C)		ZG-E Green (InGaN)	ZG-G Green (InGaN)	Y Yellow (GaAsP/GaP)	SYK Super Bright Yellow (AlGaInP)	SYK-T Super Bright Yellow (AlGaInP)	SY-H Super Bright Yellow (AlGaInP)	Unit
Reverse voltage	V _R	5	5	5	5	5	5	V
Forward current	I _F	30	30	30	30	30	30	mA
Forward current (Peak) 1/10 Duty Cycle, 0.1ms Pulse Width	I _{FS}	100	100	140	175	150	140	mA
Power dissipation	P _D	120	120	75	75	75	84	mW
LED LAMPS:								
Operating temperature	T _A	-40~+85	-40~+85	-40~+85	-40~+85	-40~+85	-40~+85	°C
Storage temperature	T _{STG}	-40~+85	-40~+85	-40~+85	-40~+85	-40~+85	-40~+85	°C
LED DISPLAYS:								
Operating temperature	T _A	-40~+85	-40~+85	-40~+85	-40~+85	-40~+85	-40~+85	°C
Storage temperature	T _{STG}	-40~+85	-40~+85	-40~+85	-40~+85	-40~+85	-40~+85	°C

Operating Characteristics		ZG-E Green (InGaN)	ZG-G Green (InGaN)	Y Yellow (GaAsP/GaP)	SYK Super Bright Yellow (AlGaInP)	SYK-T Super Bright Yellow (AlGaInP)	SY-H Super Bright Yellow (AlGaInP)	Unit
Forward voltage (typ.) I _F =20mA	V _F	3.2	3.2	2.1	2.0	2.05	2.3	V
I _F =10mA		3.05	3.05	1.95	1.95	1.95	2.2	
I _F =2mA		2.8	2.8	1.85	1.85	1.8	2	
Forward voltage (max.) I _F =20mA	V _F	4.0	4.0	2.5	2.5	2.5	2.8	V
I _F =10mA		3.4	3.4	2.4	2.35	2.3	2.6	
I _F =2mA		3.1	3.1	2.2	2.2	2.2	2.3	
Reverse current V _R =5V	I _R	50	50	10	10	10	10	uA
Peak Emission Wavelength I _F =20mA, 10mA, 2mA	λ _P	520	520	590	590	590	590	nm
Dominant Wavelength I _F =20mA, 10mA, 2mA	λ _D	525	525	588	590	590	589	nm
Spectral line half-width I _F =20mA, 10mA, 2mA	Δλ _{1/2}	35	35	35	20	15	20	nm
Capacitance V _F =0V, f=1MHZ	C	100	100	20	20	25	45	pF

TECHNICAL DATA

Absolute maximum ratings (T _A =25°C)		SYK-J3 Super Bright Yellow (AlGaInP)	SY-J3 Super Bright Yellow (AlGaInP)	MB Blue (GaN)	QB-D Blue (InGaN)	VB-D Blue (InGaN)	Unit
Reverse voltage	V _R	●	●	●	●	●	V
Forward current	I _F	30	30	30	30	30	mA
Forward current (Peak) 1/10 Duty Cycle, 0.1ms Pulse Width	i _{FS}	140	140	150	150	100	mA
Power dissipation	P _D	75	75	135	120	120	mW
LED LAMPS:							
Operating temperature	T _A	-40~+85	-40~+85	-40~+85	-40~+85	-40~+85	°C
Storage temperature	T _{STG}	-40~+85	-40~+85	-40~+85	-40~+85	-40~+85	°C
LED DISPLAYS:							
Operating temperature	T _A	-40~+85	-40~+85	-40~+85	-40~+85	-40~+85	°C
Storage temperature	T _{STG}	-40~+85	-40~+85	-40~+85	-40~+85	-40~+85	°C

Operating Characteristics		SYK-J3 Super Bright Yellow (AlGaInP)	SY-J3 Super Bright Yellow (AlGaInP)	MB Blue (GaN)	QB-D Blue (InGaN)	VB-D Blue (InGaN)	Unit
Forward voltage (typ.) I _F =20mA	V _F	●	●	●	●	●	V
I _F =10mA		2.0	2.0	3.8	3.3	3.3	
I _F =2mA		1.95	1.95	3.6	3.0	3.0	
Forward voltage (max.) I _F =20mA	V _F	1.85	1.85	3.4	2.65	2.65	V
I _F =10mA		2.5	2.5	4.5	4.0	4.0	
I _F =2mA		2.4	2.4	4.3	3.5	3.4	
Reverse current V _R =5V	I _R	2.2	2.2	3.8	3.1	3.1	uA
Peak Emission Wavelength I _F =20mA, 10mA, 2mA	λ _p	10	10	10	50	50	nm
Dominant Wavelength I _F =20mA, 10mA, 2mA	λ _D	590	590	430	460	465	nm
Spectral line half-width I _F =20mA, 10mA, 2mA	Δλ _{1/2}	590	590	466	465	470	nm
Capacitance V _F =0V, f=1MHZ	C	20	20	60	25	22	nm
		45	45	100	100	100	pF

TECHNICAL DATA 5V/12V/14V WITH INTERNAL RESISTANCE

Absolute maximum ratings (T _A =25°C)		I Hi.Eff.Red (GaAsP/GaP)	SR Super Bright Red (GaAlAs)	G Green (GaP)	Unit
Reverse voltage	V _R	5	5	5	V
Forward voltage (Max.) for 5V	V _F	6	6	6	V
Forward voltage (Max.) for 12V	V _F	14	14	14	V
Forward voltage (Max.) for 14V	V _F	16	16	16	V
Power dissipation for 5V	P _D	85	85	85	mW
Power dissipation for 12V	P _D	120	120	120	mW
Power dissipation for 14V	P _D	160	160	160	mW
LED LAMPS:					
Operating temperature	T _A	-40~+70	-40~+70	-40~+70	°C
Storage temperature	T _{STG}	-40~+85	-40~+85	-40~+85	°C
LED DISPLAYS:					
Operating temperature	T _A	-40~+70	-40~+70	-40~+70	°C
Storage temperature	T _{STG}	-40~+85	-40~+85	-40~+85	°C

Operating Characteristics		I Hi.Eff.Red (GaAsP/GaP)	SR Super Bright Red (GaAlAs)	G Green (GaP)	Unit
Forward current (typ.) V _F =5V	I _F	13	13	11.5	mA
Forward current (typ.) V _F =12V	I _F	8.5	8.5	8.5	mA
Forward current (typ.) V _F =14V	I _F	10.5	10.5	10.5	mA
Forward current (max.) V _F =5V	I _F	17.5	17.5	17.5	mA
Forward current (max.) V _F =12V	I _F	11.5	11.5	11.5	mA
Forward current (max.) V _F =14V	I _F	13.5	13.5	13.5	mA
Reverse current V _R =5V	I _R	10	10	10	uA
Peak Emission Wavelength V _F =5V,12V,14V	λ _p	627	655	565	nm
Dominant Wavelength V _F =5V,12V,14V	λ _D	617	640	568	nm
Spectral line half-width V _F =5V,12V,14V	Δλ _{1/2}	45	20	30	nm

TECHNICAL DATA FOR BLINKING LED LAMPS

Absolute maximum ratings (T _A =25°C)		I Hi.Eff.Red (GaAsP/GaP)	H Bright Red (GaP)	SR Super Bright Red (GaAlAs)	Unit
Reverse voltage	V _R	0.5	0.5	0.5	V
Forward voltage (max.)	V _F	14	14	14	V
Total Power dissipation	P _D	310	310	310	mW
Operating temperature	T _A	- 40~+70	- 40~+70	- 40~+70	°C
Storage temperature	T _{STG}	- 40~+85	- 40~+85	- 40~+85	°C

Operating Characteristics		I Hi.Eff.Red (GaAsP/GaP)	H Bright Red (GaP)	SR Super Bright Red (GaAlAs)	Unit
Forward current (min.) V _F =3.5V	I _F	8	8	8	mA
Forward current (typ.) V _F =5V	I _F	22	22	22	mA
Supply current V _F =3.5V ~ 14V	I _{SON}	8 ~ 44	8 ~ 44	8 ~ 44	mA
Blink frequency V _F =3.5V ~ 14V	f	3 ~ 1.5	3 ~ 1.5	3 ~ 1.5	Hz
Peak Emission Wavelength	λ _p	627	700	655	nm
Dominant Wavelength	λ _D	617	635	640	nm
Spectral line half-width	Δλ _{1/2}	45	45	20	nm

TECHNICAL DATA FOR INFRARED

Absolute maximum ratings ($T_A=25^\circ\text{C}$)		F3 (GaAs)	SF4 (GaAlAs)	SF6 (GaAlAs)	SF7 (GaAlAs)	Unit
Reverse voltage	V_R	5	5	5	5	V
Forward current	I_F	50	50	50	50	mA
Forward current (Peak) 1/100 Duty Cycle, 10 μs Pulse Width	I_{FS}	1.2	1.2	1	1	A
Power dissipation	P_D	90	85	85	95	mW
LED LAMPS:						
Operating temperature	T_A	-40~+85	-40~+85	-40~+85	-40~+85	$^\circ\text{C}$
Storage temperature	T_{STG}	-40~+85	-40~+85	-40~+85	-40~+85	$^\circ\text{C}$
LED DISPLAYS:						
Operating temperature	T_A	-40~+85	-40~+85	-40~+85	-40~+85	$^\circ\text{C}$
Storage temperature	T_{STG}	-40~+85	-40~+85	-40~+85	-40~+85	$^\circ\text{C}$

Operating Characteristics		F3 (GaAs)	SF4 (GaAlAs)	SF6 (GaAlAs)	SF7 (GaAlAs)	Unit
Forward voltage (typ.) $I_F=20\text{mA}$	V_F	1.2	1.3	1.35	1.4	V
Forward voltage (max.) $I_F=20\text{mA}$	V_F	1.6	1.6	1.6	1.6	V
Reverse current $V_R=5\text{V}$	I_R	10	10	10	10	μA
Peak Emission Wavelength $I_F=20\text{mA}$	λ_p	940	880	860	850	nm
Spectral line half-width $I_F=20\text{mA}$	$\Delta\lambda_{1/2}$	50	50	50	50	nm
Capacitance $V_F=0\text{V}, f=1\text{MHZ}$	C	90	90	30	30	pF

TECHNICAL DATA

High Efficiency Red, Orange

E, I : GaAsP/GaP

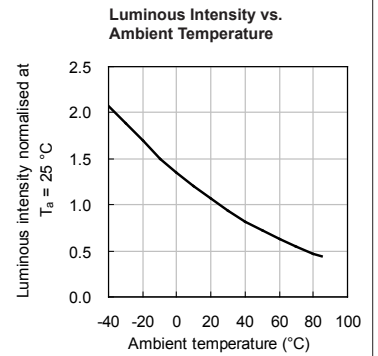
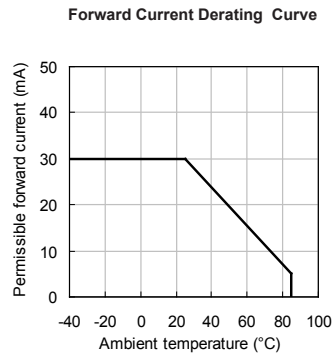
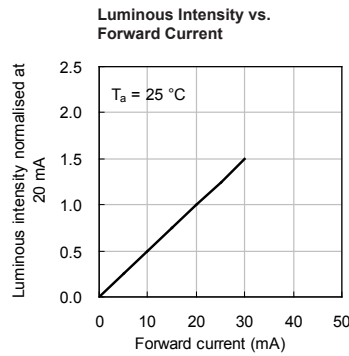
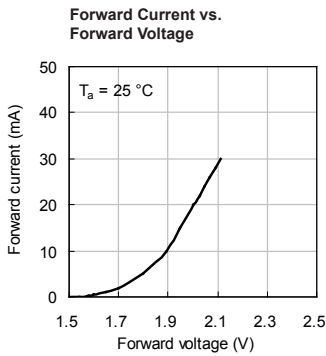

Bright Red

H : GaP

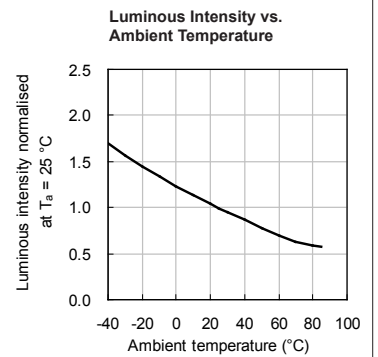
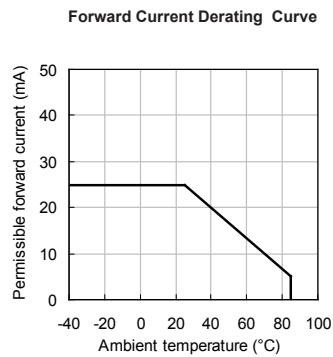
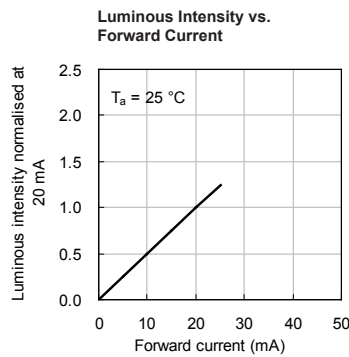
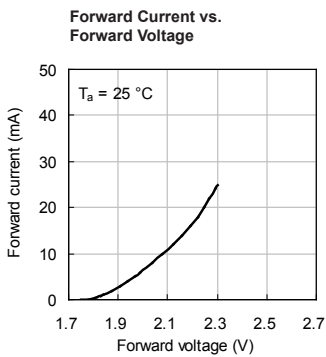

Super Bright Red

SR : GaAlAs

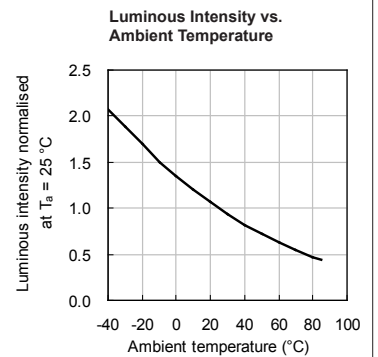
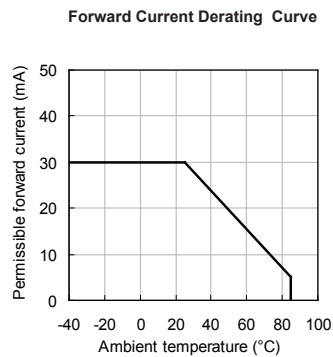
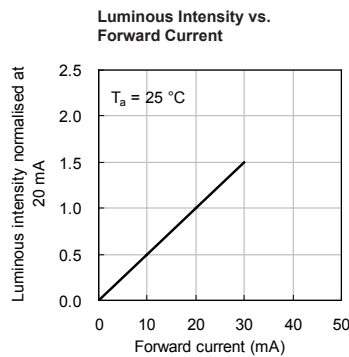
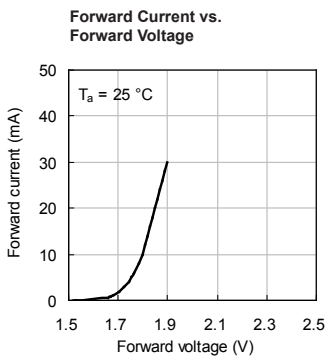

Super Bright Red

SR-J4 : AlGaInP

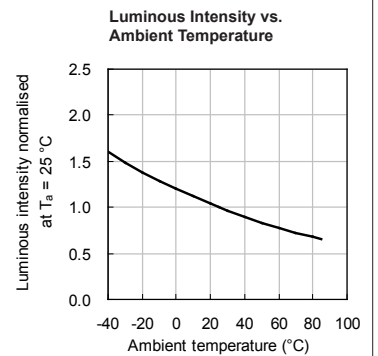
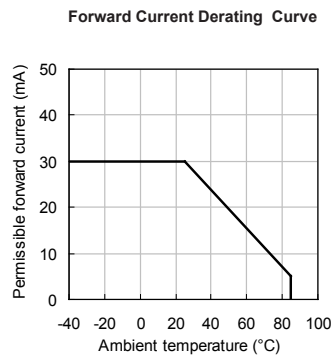
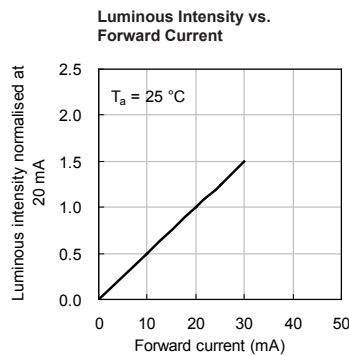
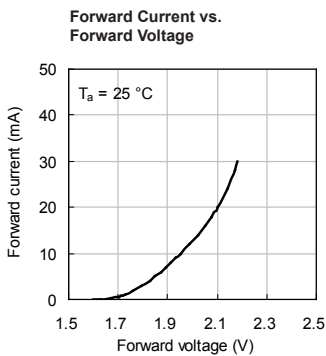

TECHNICAL DATA

Hyper Red

SURK : AlGaInP

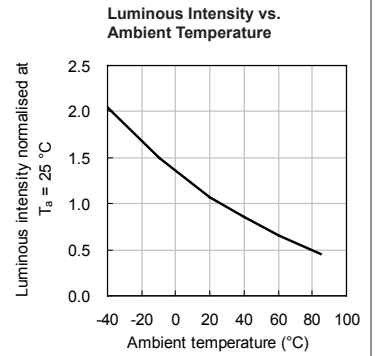
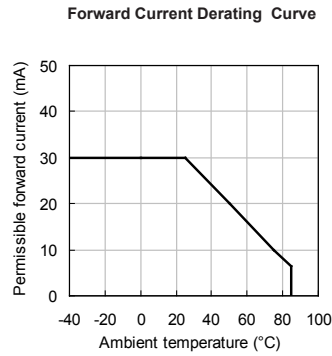
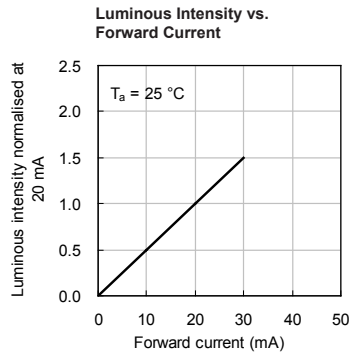
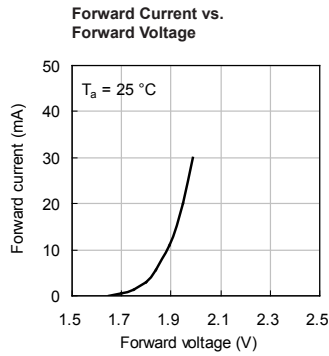

Hyper Red

SURK-T : AlGaInP

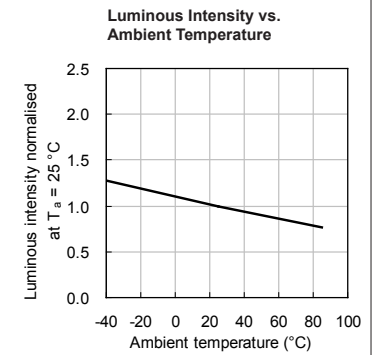
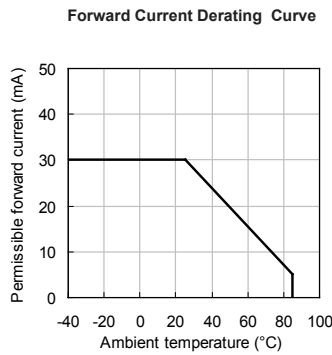
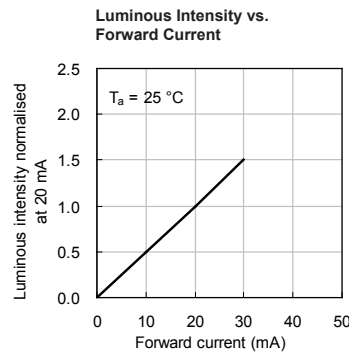
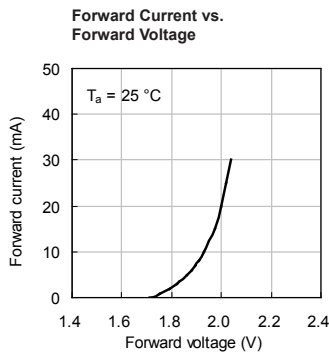

Hyper Red

SUR-E : AlGaInP

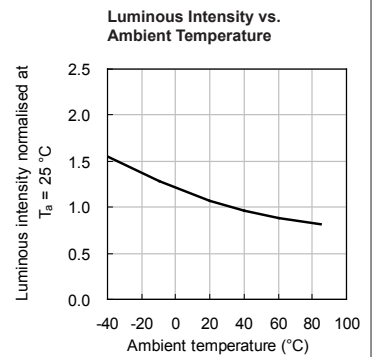
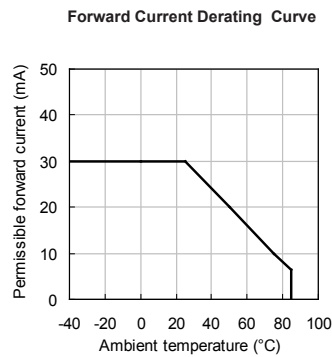
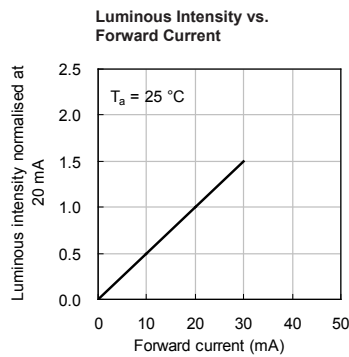
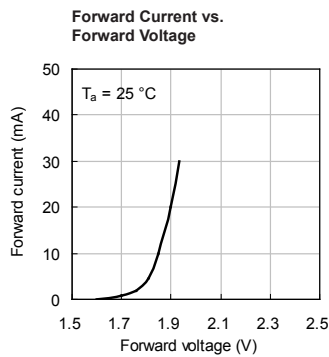

Hyper Red

SEK-J3, SE-J3 : AlGaInP

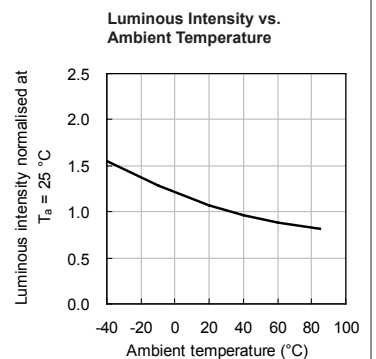
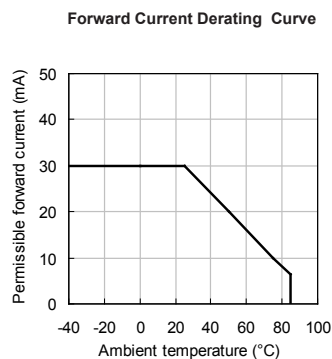
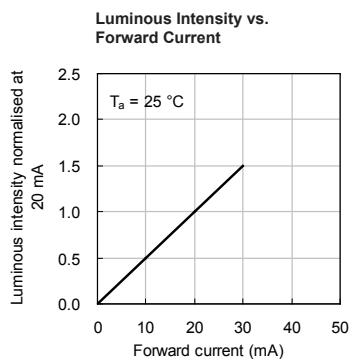
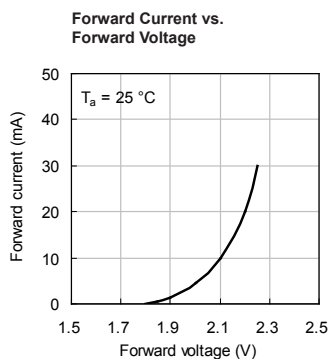

TECHNICAL DATA

Hyper Red

SE-E : AlGaInP

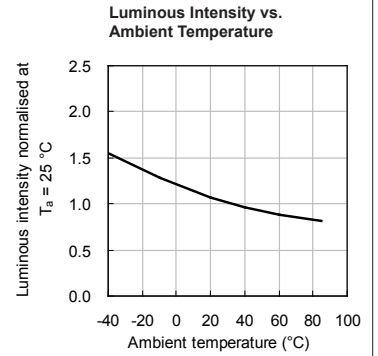
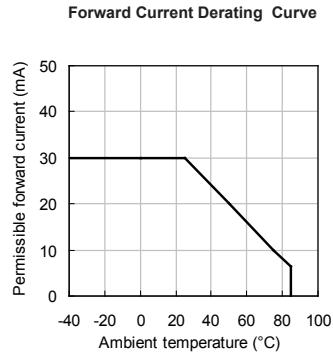
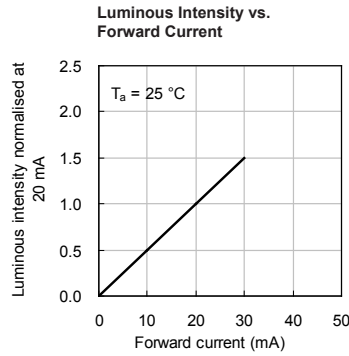
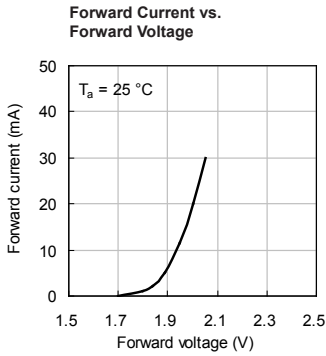

Hyper Red

SE-H : AlGaInP

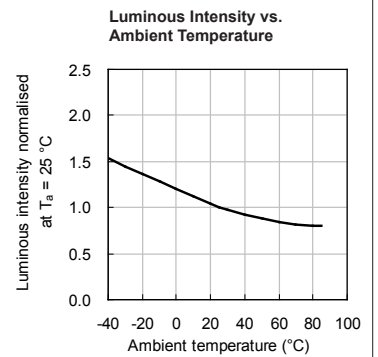
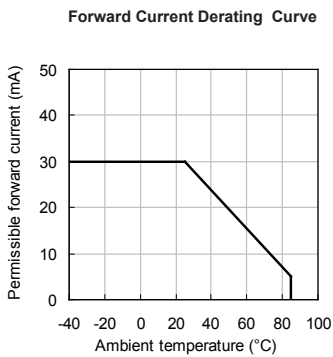
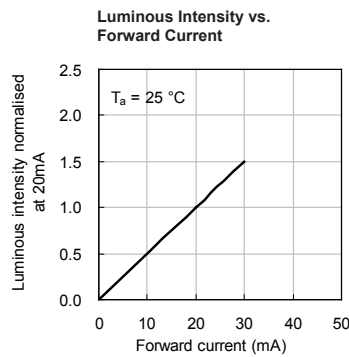
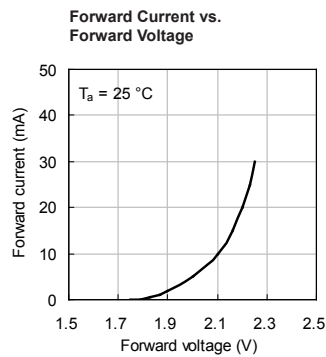

Super Bright Orange

SEK-J4 : AlGaInP

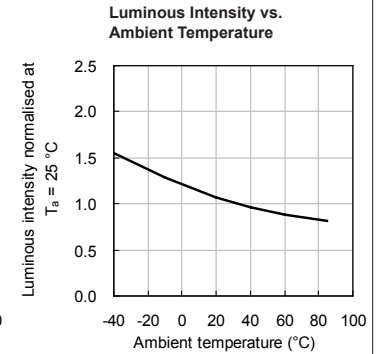
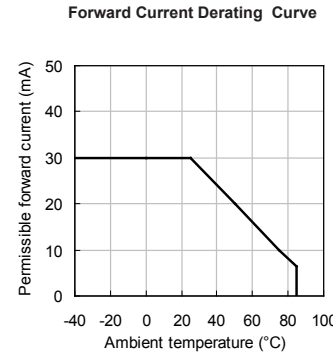
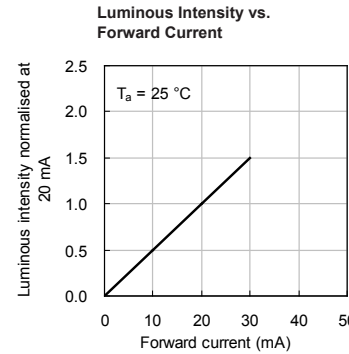
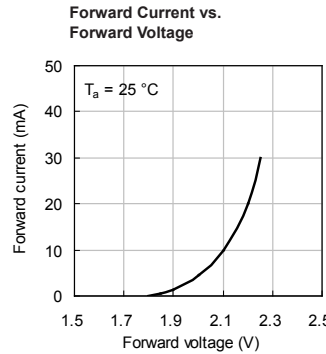

Pure Orange

N : GaAsP/GaP

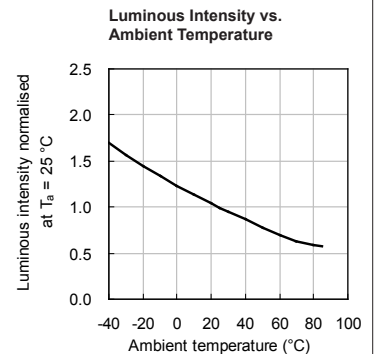
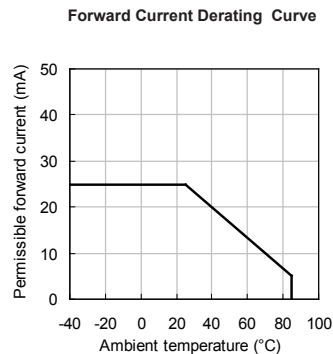
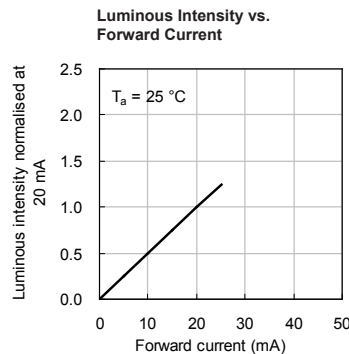
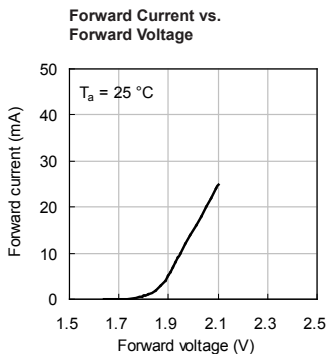

TECHNICAL DATA

Super Bright Orange

SEK : AlGaInP

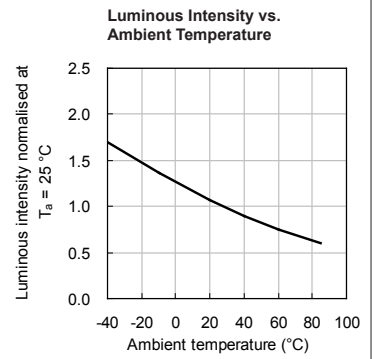
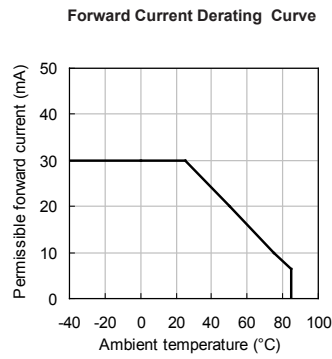
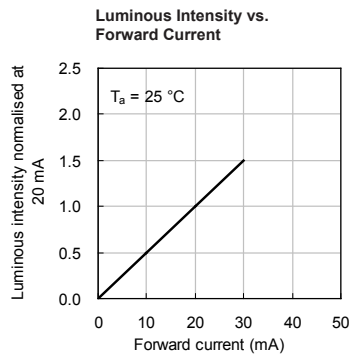
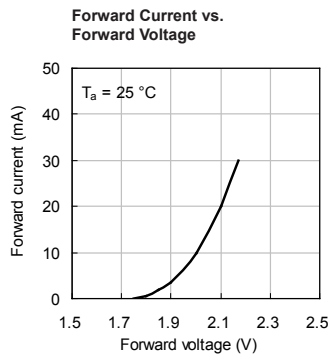

Super Bright Orange

SEK-T : AlGaInP

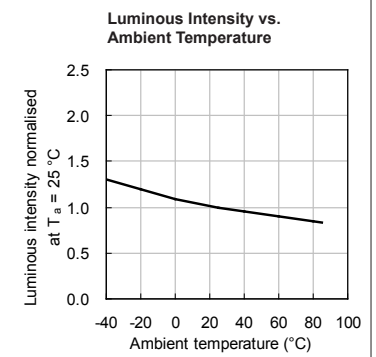
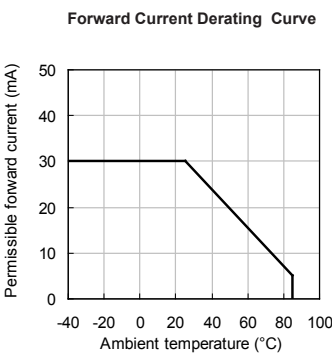
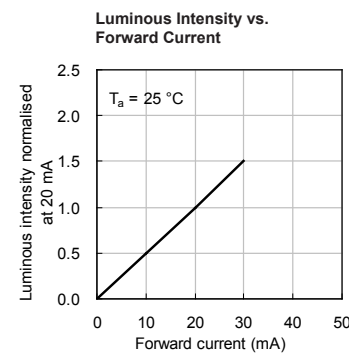
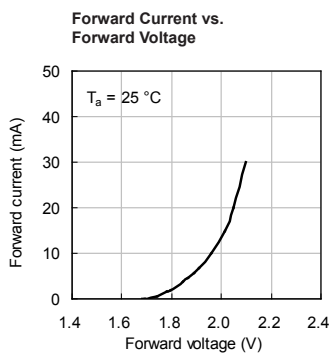

Green/Super Bright Green

G, SG : GaP

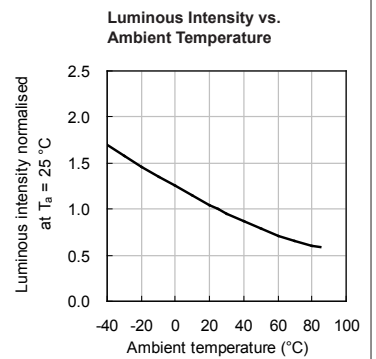
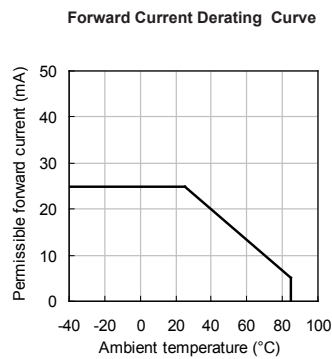
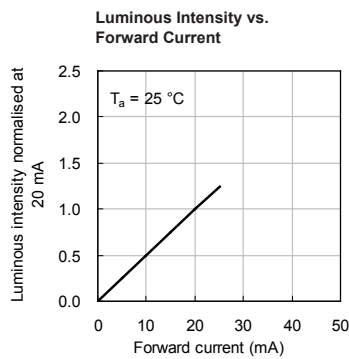
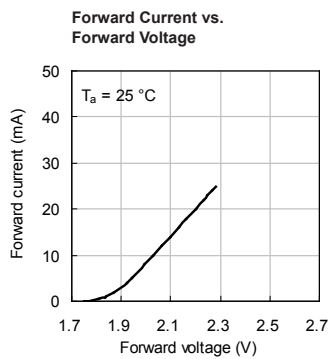

Green

CG-KA : AlGaInP

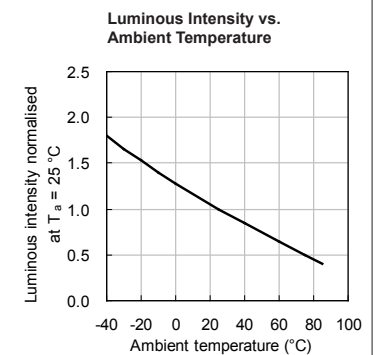
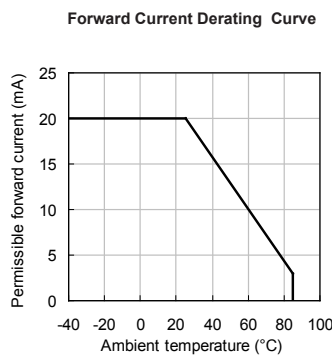
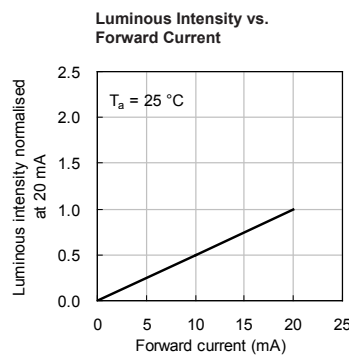
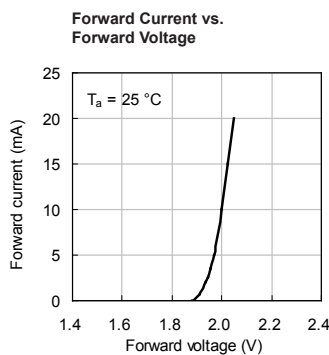

TECHNICAL DATA

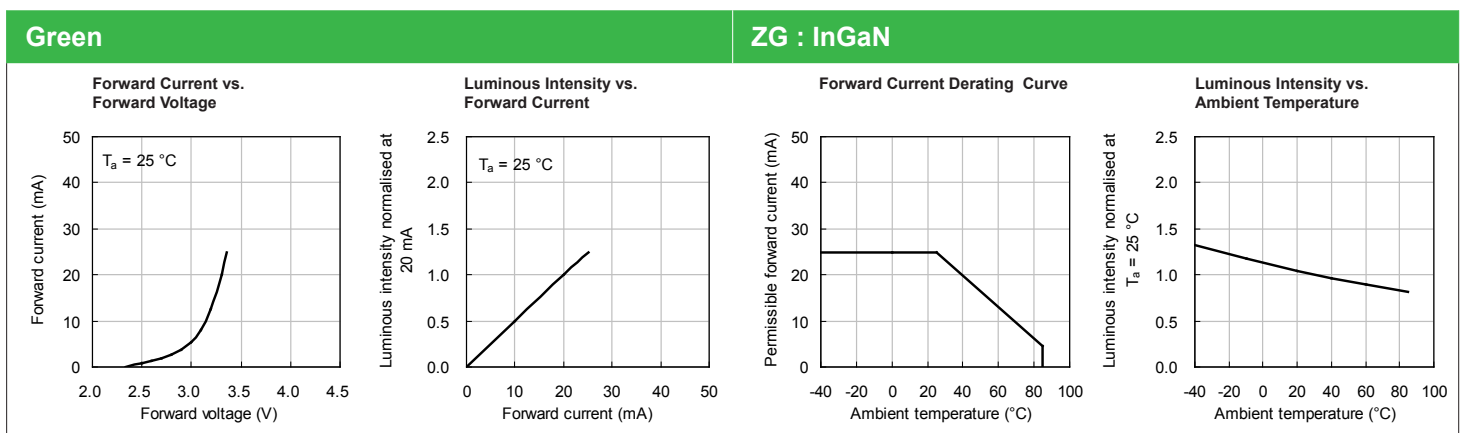
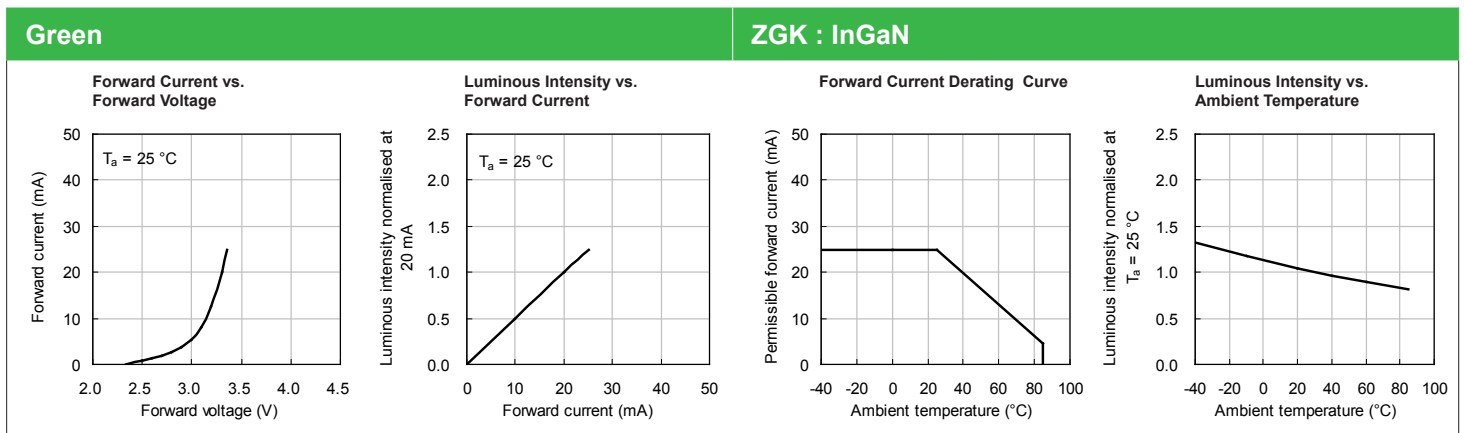
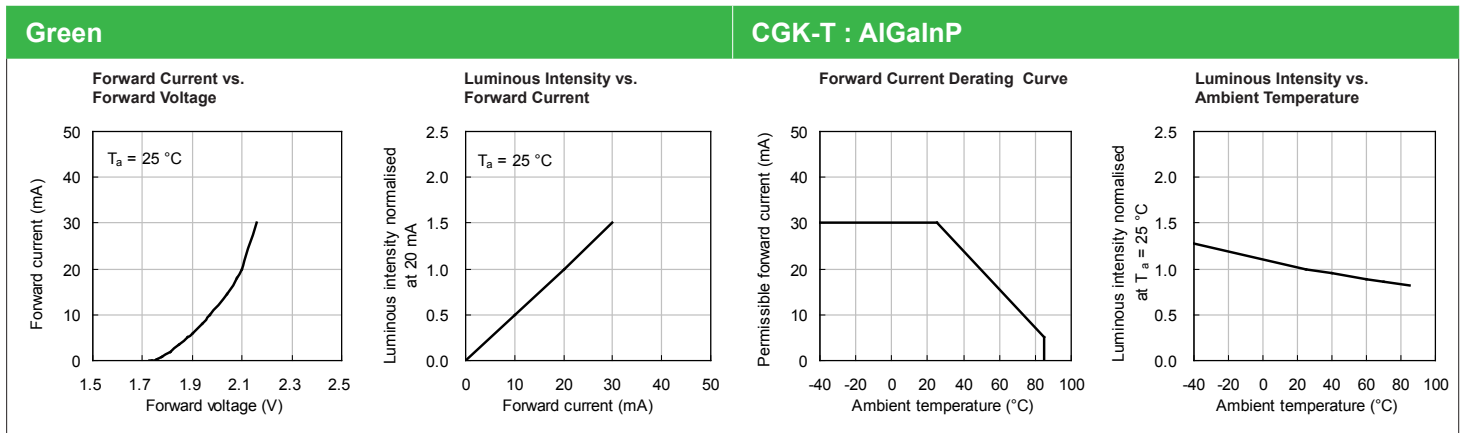
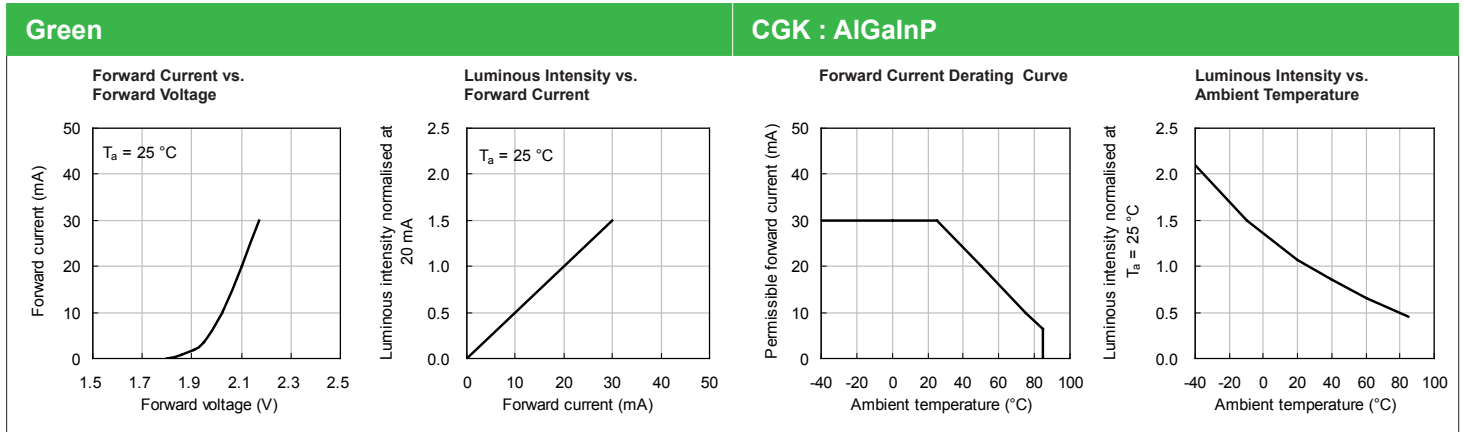

TECHNICAL DATA

Green

ZG-E, ZG-G : InGaN

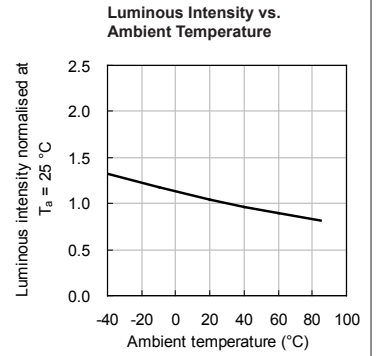
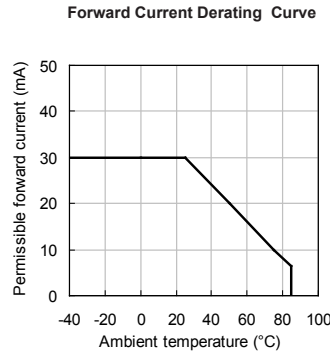
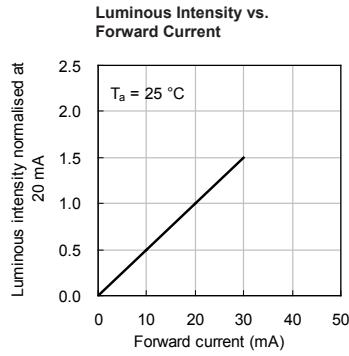
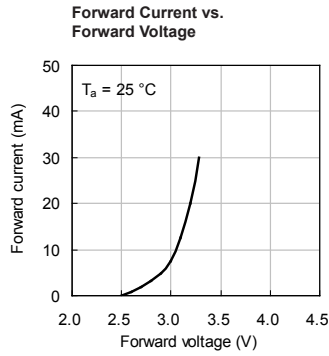

Yellow

Y : GaAsP/GaP

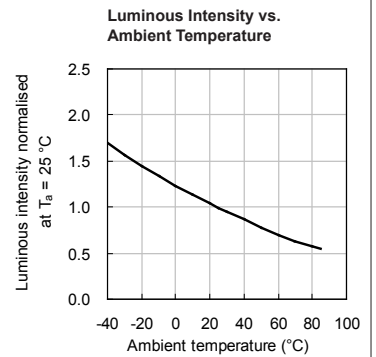
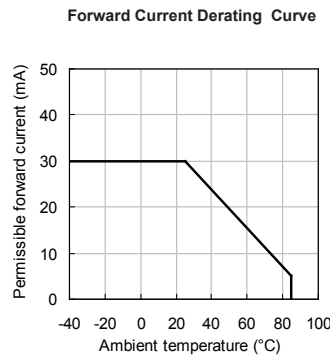
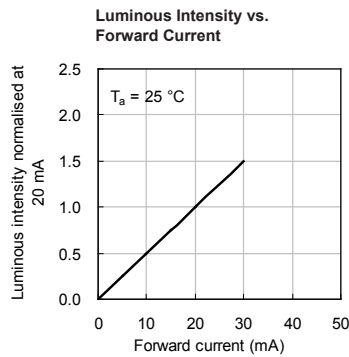
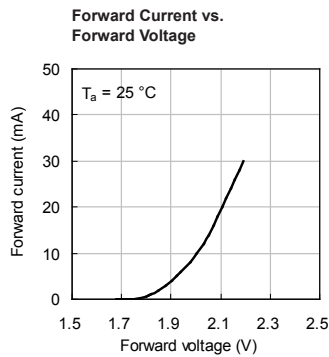

Super Bright Yellow

SYK, SYK-J3, SY-J3 : AlGaInP

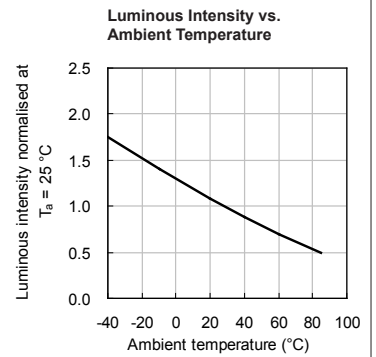
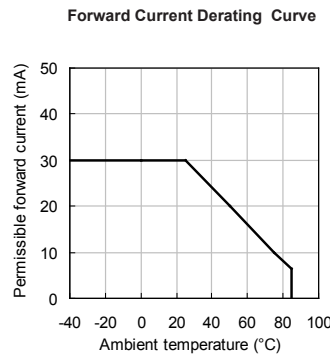
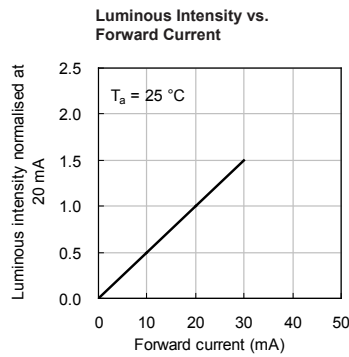
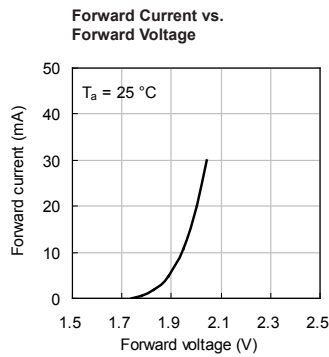

Super Bright Yellow

SYK-T : AlGaInP

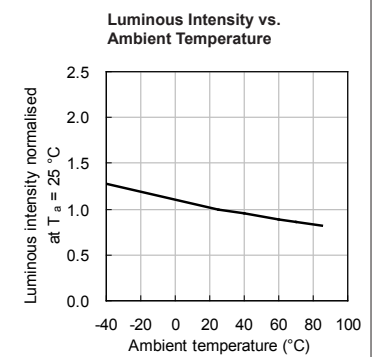
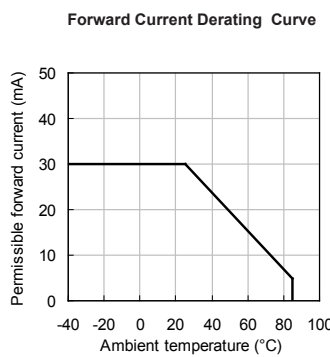
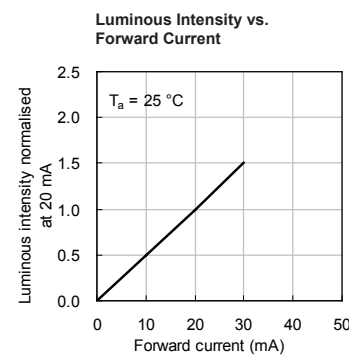
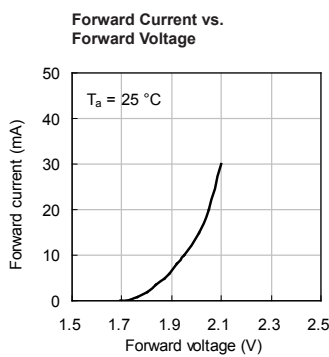

TECHNICAL DATA

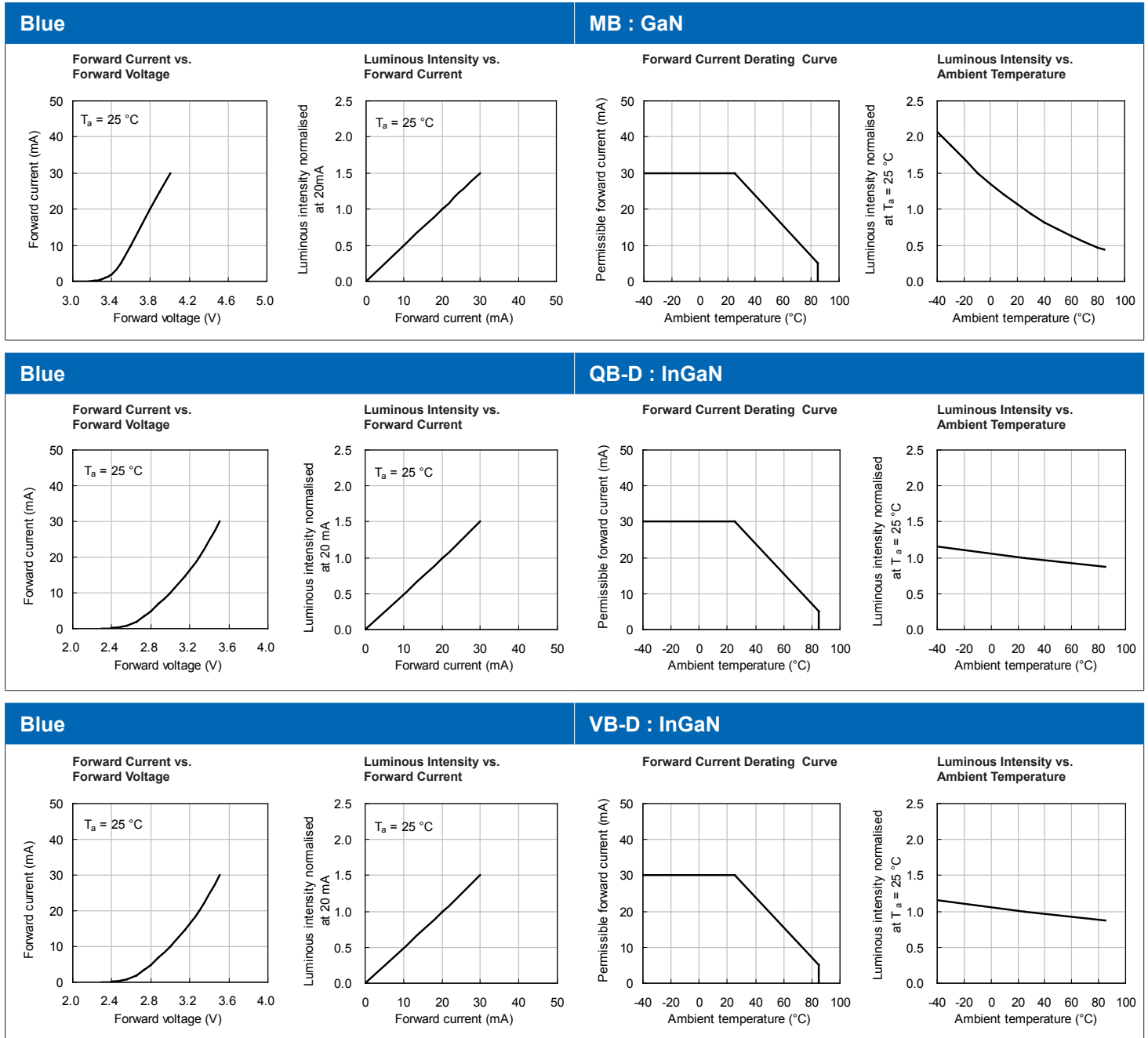

BIN CODE SYSTEMS

SELECTION CODE FOR STANDARD AND LOW CURRENT LEDs

(T_A=25°C Tolerance +/-15% IF<15mA)

Group	Light intensity in mcd		Group	Light intensity in mcd	
	Min.	Max.		Min.	Max.
F	0.1	0.2	W	120	180
G	0.2	0.35	X	180	250
H	0.35	0.5	Y	250	320
I	0.5	0.8	Z	320	450
K	0.8	1.2	ZA	450	550
L	1.2	2	ZB	550	700
M	2	4	ZC	700	1000
N	4	6	ZD	1000	1600
P	6	10	ZE	1600	2200
Q	10	15	ZF	2200	2800
R	15	20	ZG	2800	3400
S	20	30	ZH	3400	4300
T	30	50	ZM	4300	5200
U	50	80	ZN	5200	6300
V	80	120	ZP	6300	7400

SELECTION CODE FOR NPN PHOTOTRANSISTORS

(T_A=25°C Tolerance +/-15%)

Group	Photocurrent(mA)		Group	Photocurrent(mA)	
	Min.	Max.		Min.	Max.
F	0.1	0.2	L	1.2	2
G	0.2	0.35	M	2	4
H	0.35	0.5	N	4	6
I	0.5	0.8	P	6	10
K	0.8	1.2	-	-	-

SELECTION CODE FOR INFRARED EMITTING DIODES

(T_A=25°C Tolerance +/-15%)

Group	Radiant intensity in mW/sr		Group	Radiant intensity in mW/sr	
	Min.	Max.		Min.	Max.
AK	0.8	1.2	D	8	12
AL	1.2	2	E	12	20
A	2	3	F	20	40
B	3	5	G	40	55
C	5	8	H	55	80

SELECTION CODE FOR SUPER BRIGHT LEDs

(T_A=25°C Tolerance +/-15% IF≥15mA)

Group	Light intensity in mcd		Group	Light intensity in mcd	
	Min.	Max.		Min.	Max.
A	2	3	ZA	3100	3600
B	3	5	ZB	3600	4200
C	5	8	ZC	4200	5000
D	8	12	ZD	5000	6000
E	12	20	ZE	6000	7000
F	20	40	ZF	7000	8000
G	40	55	ZG	8000	9000
H	55	80	ZH	9000	11000
M	80	120	ZM	11000	14000
N	120	200	ZN	14000	18000
P	200	300	ZP	18000	22000
Q	300	400	ZQ	22000	27000
R	400	500	ZR	27000	35000
S	500	700	ZS	35000	43000
T	700	1000	ZT	43000	55000
U	1000	1300	ZU	55000	75000
V	1300	1600	ZV	75000	130000
W	1600	1900	ZW	130000	200000
X	1900	2300	ZX	200000	320000
Y	2300	2700	ZY	320000	490000
Z	2700	3100	ZZ	490000	800000

SELECTION CODE FOR DISPLAYS

(T_A=25°C Tolerance +/-15% IF≤10mA)

Group	Light intensity in ucd		Group	Light intensity in ucd	
	Min.	Max.		Min.	Max.
C	70	140	P	14000	21000
D	140	240	Q	21000	31000
E	240	360	R	31000	52000
F	360	560	S	52000	88000
G	560	900	T	88000	150000
H	900	1400	U	150000	255000
I	1400	2200	V	255000	433000
K	2200	3600	W	433000	736000
L	3600	5600	X	736000	1251000
M	5600	9000	Y	1251000	2126000
N	9000	14000	Z	2126000	3614000

BIN CODE SYSTEMS

SELECTION CODE FOR LUMINOUS FLUX (T _A =25°C; Tolerance: +/-15%)					
Group	Luminous Flux in lm		Group	Luminous Flux in lm	
	Min.	Max.		Min.	Max.
A1	0.5	0.6	B10	50	60
A2	0.6	0.7	B11	60	70
A3	0.7	0.8	B12	70	80
A4	0.8	1	B13	80	90
A5	1	1.2	B14	90	100
A6	1.2	1.4	C1	100	120
A7	1.4	1.7	C2	120	140
A8	1.7	2	C3	140	160
A9	2	2.4	C4	160	180
A10	2.4	2.9	C5	180	210
A11	2.9	3.5	C6	210	240
A12	3.5	4.2	C7	240	280
A13	4.2	5	C8	280	320
A14	5	6	C9	320	370
A15	6	7.2	C10	370	430
A16	7.2	8.6	C11	430	490
A17	8.6	10	C12	490	560
B1	10	12	C13	560	640
B2	12	14	C14	640	740
B3	14	17	C15	740	850
B4	17	20	C16	850	1000
B5	20	24	D1	1000	1200
B6	24	29	D2	1200	1400
B7	29	35	D3	1400	1600
B8	35	42	D4	1600	1800
B9	42	50	D5	1800	2100

COLOR CODE FOR GREEN LEDS + DISPLAYS (T _A =25°C; Tolerance: +/-1nm)				
Group	Dom. Wavelength (nm)			
	Min.	Max.	Min.	Max.
0	556	559	-	-
1	559	561	515	520
2	561	563	520	525
3	563	565	525	530
4	565	567	530	535
5	567	569	535	540
6	569	571	-	-
7	571	573	-	-
8	573	575	-	-

COLOR CODE FOR BLUE LEDS + DISPLAYS (T _A =25°C; Tolerance: +/-1nm)					
Group	Dom. Wavelength (nm)		Group	Dom. Wavelength (nm)	
	Min.	Max.		Min.	Max.
1	445	450	3A	471	473
2	450	455	3B	473	475
3	455	460	4A	475	477
1A	460	463	4B	477	479
1B	463	466	5A	479	481
2A	466	469	5B	481	483
2B	469	471	5C	483	486

COLOR CODE FOR YELLOW LEDS + DISPLAYS (T _A =25°C; Tolerance: +/-1nm)					
Group	Dom. Wavelength (nm)		Group	Dom. Wavelength (nm)	
	Min.	Max.		Min.	Max.
1	581	584	5	590	592
2	584	586	6	592	594
3	586	588	7	594	597
4	588	590	8	597	600

SOLDERING INSTRUCTIONS						
Types	Dip soldering / * wave soldering			Iron soldering (with 1.5mm iron tip)		
	Temperature of the soldering bath	Maximum soldering time	Distance from solder joint to package	Temperature of soldering iron	Maximum soldering time	Distance from solder joint to package
LEDS	<=260°C	3s	>=2mm	<=350°C	3s	>2mm
	<=260°C	5s	>=5mm	<=350°C	5s	>5mm
SMDS	-	-	-	<=350°C	3s (one time only)	-
DISPLAYS	*<=260°C	*3s	*>2mm	<=350°C	3s	>2mm
PHOTOCOUPLER	<=260°C	3s	>2mm	<=310°C	3s	-
	-	-	-	<=260°C	10s	-

APPLICATION NOTES

General Notes

1. We recommend manual soldering operations only for repair and rework purposes. The soldering iron should be temperature-controlled to avoid damaging the component. The maximum soldering temperature is 300°C for Pb-Sn solder and 350°C for lead-free solder for normal lamps and displays. For blue (typ.:465nm), green (typ.:525nm), and all white LEDs, the maximum soldering iron temperature is 280°C. Do not place the soldering iron on the component for more than 3 seconds.

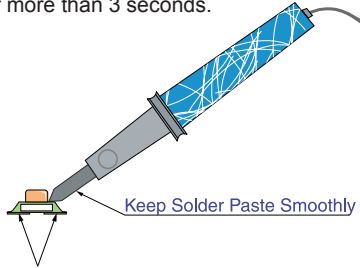

- The tip of the soldering iron should never touch the epoxy lens.
- Do not apply stress to the leads when the component is heated above 85°C, otherwise internal wire bonds may be damaged.
- Through-Hole LEDs are incompatible with reflow soldering.
- If the LED will undergo multiple soldering passes or face other processes where the part may be subjected to intense heat, please check with Kingbright for compatibility.
- SMD products must be mounted according to specified soldering pad patterns. Refer to the product datasheet for details. Solder paste must be evenly applied to each soldering pad to insure proper bonding and positioning of the component.

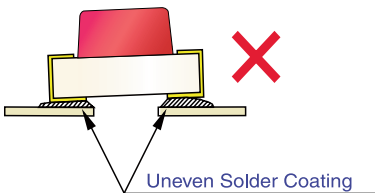

- After soldering, allow at least three minutes for the component to cool down to room temperature before further operations.
- Recommended PCB pin hole diameters for display products are listed below :
 Square pin type : $\Phi 1\text{mm}$
 Round pin type : 2 x pin diameters

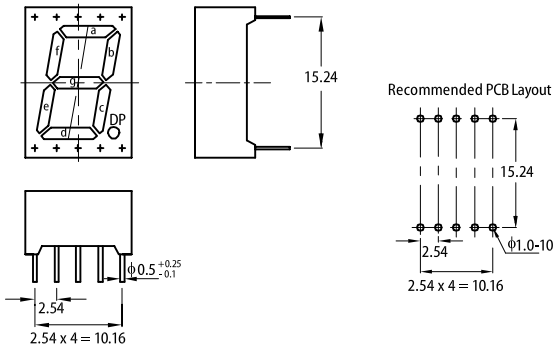

9. Data subject to change without notice. For additional detail of application notes, product information, and disclaimers, please visit our website at https://www.kingbright.com/application_notes.

Recommended Wave Soldering Profiles For Kingbright Through-Hole Products

1. Lead-Free Wave Soldering Profile

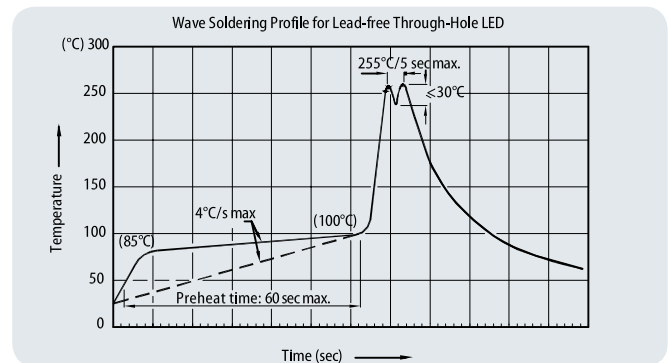

Notes:

- Recommend pre-heat temperature of 105°C or less (as measured with a thermocouple attached to the LED pins) prior to immersion in the solder wave with a maximum solder bath temperature of 260°C.
- Peak wave soldering temperature between 245°C ~ 255°C for 3 sec (5 sec max).
- Do not apply stress to the epoxy resin while the temperature is above 85°C.
- Fixtures should not incur stress on the component when mounting and during soldering process.
- SAC 305 solder alloy is recommended.
- No more than one wave soldering pass.
- During wave soldering, the PCB top-surface temperature should be kept below 105°C.

2. Wave Soldering Profile With Pb-Sn Solder

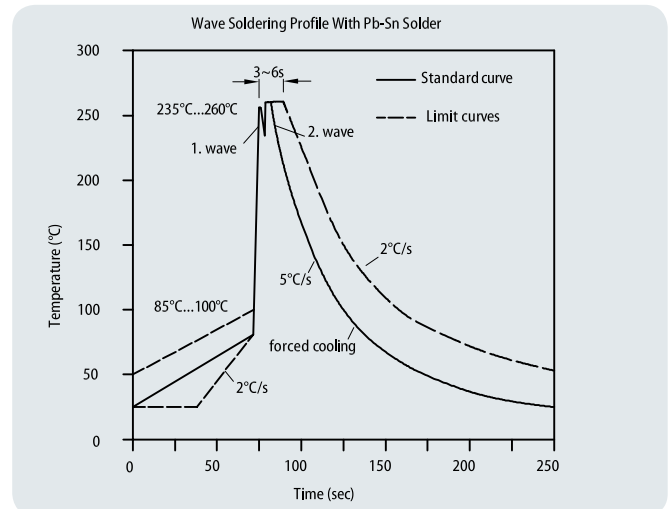

Recommended Reflow Soldering Profiles For Kingbright SMD Products

1. Lead-Free Reflow Soldering Profile

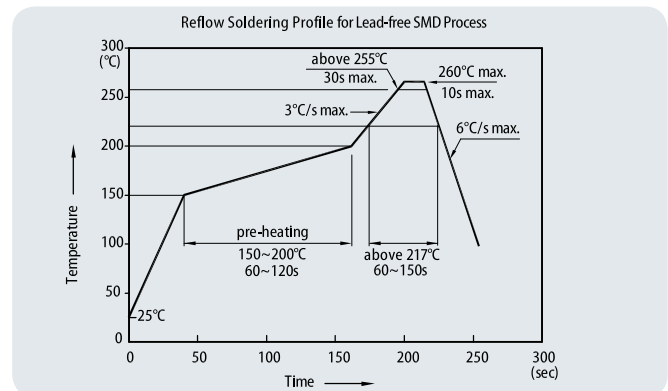

Notes:

- Don't cause stress to the LEDs while it is exposed to high temperature.
- The maximum number of reflow soldering passes is 2 times.

2. Reflow Soldering Profiles With Pb-Sn Solder

No more than two soldering passes with the recommended profile.

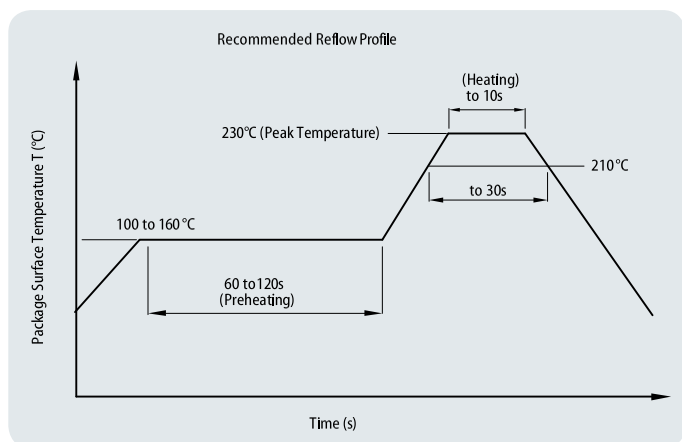

Static Electricity and Voltage Spikes in InGaN/GaN Products

InGaN/GaN products are sensitive to electrostatic discharge (ESD) and other transient voltage spikes. ESD and voltage spikes can affect the component's reliability, increase reverse current, and decrease forward voltage. This may result in reduced light intensity or cause component failure.

Kingbright InGaN/GaN products are stored in anti-static packaging for protection during transport and storage. Please note the anti-static measures below when handling Kingbright InGaN/GaN products.

Design Precautions

Products using InGaN/GaN components must incorporate protection circuitry to prevent ESD and voltage spikes from reaching the vulnerable component.

ESD Protection During Production

Static discharge can result when static-sensitive products come in contact with the operator or other conductors. The following procedures may decrease the possibility of ESD damage:

1. Minimize friction between the product and surroundings to avoid static buildup.
2. All manufacturing and testing equipment should be grounded.
3. All personnel in an ESD protected area should wear antistatic garments and wrist straps.
4. Set up ESD protection areas using grounded metal plating for component handling.
5. All workstations that handle IC and ESD-sensitive components must maintain an electrostatic potential of 150V or less.
6. Relative humidity levels maintained between 40% and 60% in production area are recommended to avoid the build-up of static electricity – Ref JEDEC/JESD625-A and JEDEC/J-STD-033.
7. Use anti-static packaging for transport and storage.
8. All anti-static equipment and procedures should be periodically inspected and evaluated for proper functionality.

LED Mounting Method

1. The lead pitch of the LED must match the pitch of the mounting holes on the PCB during component placement. Lead-forming may be required to insure the lead pitch matches the hole pitch. Refer to (Fig.1) for proper lead forming procedures.

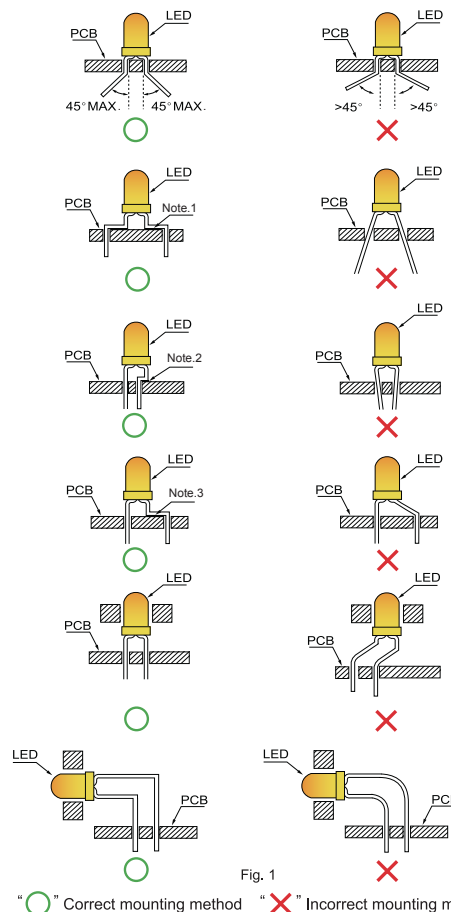

2. When soldering wires to the LED, each wire joint should be separately insulated with heat-shrink tube to prevent short-circuit contact. Do not bundle both wires in one heat shrink tube to avoid pinching the LED leads. Pinching stress on the LED leads may damage the internal structures and cause failure. (Fig.2)

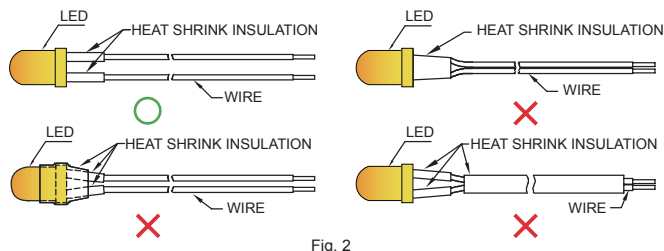

3. Use stand-offs (Fig.3) or spacers (Fig.4) to securely position the LED above the PCB.

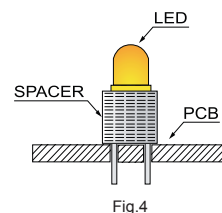
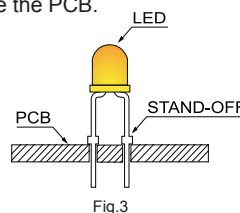

- Do not route PCB trace in the contact area between the leadframe and the PCB to prevent short-circuits.

Lead Forming Procedures

- Maintain a minimum of 3mm clearance between the base of the LED lens and the first lead bend. (Fig.5 and 6)

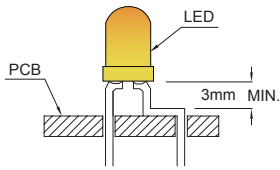

Fig. 5

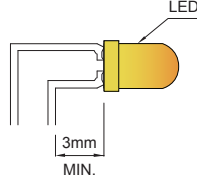

Fig. 6

- Lead forming or bending must be performed before soldering, never during or after soldering.
- Do not stress the LED lens during lead-forming in order to prevent fractures in the epoxy lens and damage the internal structures.
- During soldering, component covers and holders should leave clearance to avoid placing damaging stress on the LED during soldering. (Fig.7)

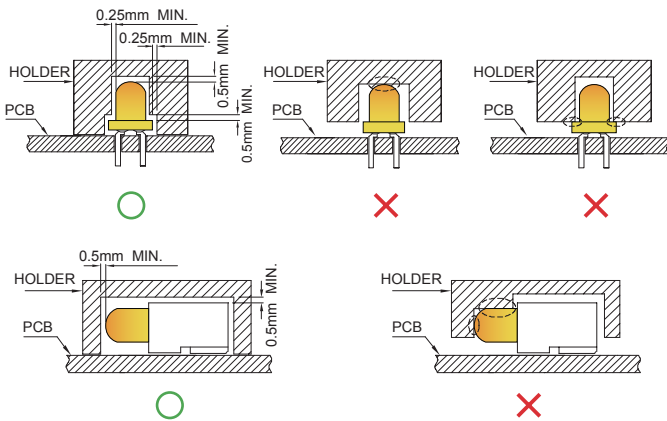

Fig. 7

- During lead forming, use tools or jigs to hold the leads securely so that the bending force will not be transmitted to the LED lens and its internal structures. Do not perform lead forming once the component has been mounted onto the PCB. (Fig.8)

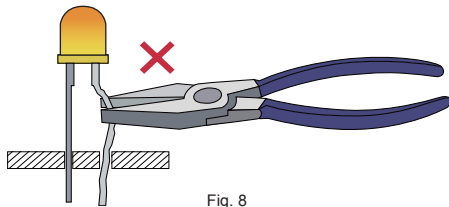

Fig. 8

- Do not bend the leads more than twice. (Fig.9)

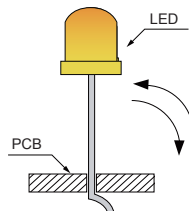

Fig. 9

- After soldering or other high-temperature assembly, allow the LED to cool down to 50°C before applying outside force (Fig.10). In general, avoid placing excess force on the LED to avoid damage. For any questions, please consult with Kingbright representative for proper handling procedures.

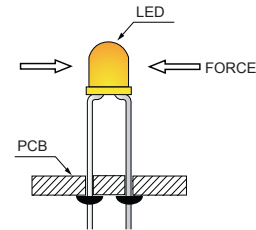

Fig. 10

Cleaning

For SMD and through-hole LEDs

- Isopropyl alcohol or deionizer water are recommended for cleaning. Do not use acidic solvents or unknown chemicals, as they might cause corrosion or damage to the component.
- Lightly wipe away any surface contaminants, and allow the component to dry under room temperature before further usage. Do not soak the component in solution.

For LED Displays

- The component should be washed with only water, and immediately dried by forced-air to remove excess moisture. Do not use harsh organic solvents because they might damage the plastic parts.
- The cleaning process should take place at room temperature and the component should not be washed for more than one minute.

Miscellaneous Design Notes

- Protective current-limiting resistors may be necessary to operate the LEDs within the specified range.
- LEDs mounted in parallel should each be placed in series with its own current-limiting resistor.

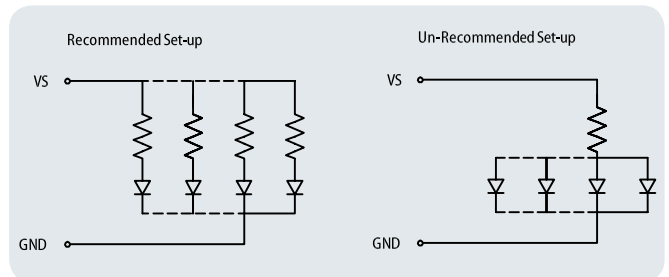

- The driving circuit should be designed to avoid reverse voltages and transient voltage spikes when the circuit is powered up or shut down.
- High temperatures can reduce device performance and reliability. Keep LED devices away from heat source for best performance.
- The safe operation current should be chosen after considering the maximum ambient temperature of the operating environment.
- During soldering, SMD components should be mounted such that the leads are placed perpendicular to the direction of PCB travel to ensure the solder on each lead melts simultaneously during reflow.

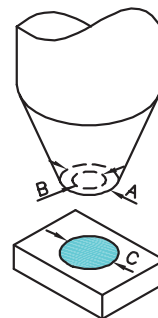
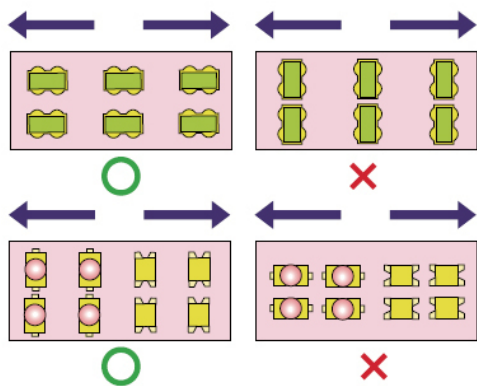

A is the outer diameter of the pick-up nozzle
 B is the inner diameter of the pick-up nozzle
 C is the diameter of lens

7. Optimal usage of high-power LED devices requires careful design by the end-user to optimize heat dissipation, such as increasing the size of the metal backing around the soldering pad. Refer to the product datasheet for specific design recommendations regarding heat dissipation.

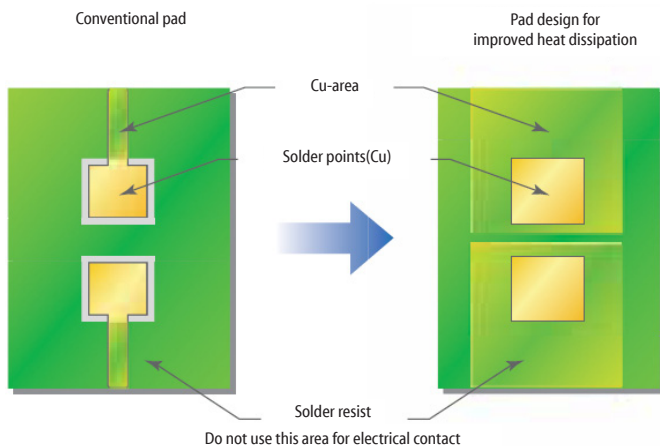

Restrictions on Product Use

1. Not all devices and product families are available in every country.
2. The light output from UV, blue, white, and other high-power LEDs may cause injury to the human eye when viewed directly.
3. LED devices may contain gallium arsenide (GaAs) material. GaAs is harmful if ingested. GaAs dust and fumes are toxic. Do not break, cut, or pulverize LED devices. Do not dissolve LEDs in chemical solvents.
4. Semiconductor devices can fail or malfunction due to their sensitivity to electrical fluctuation and physical stress. It is the responsibility of the user to observe all safety standards when using Kingbright products, in order to avoid situations in which the malfunction or failure of a Kingbright product could cause injury, property damage, or the loss of human life. In developing designs, please insure that Kingbright products are used within specified operating conditions as set forth in the most recent product specification datasheet.
5. For LEDs with silicone encapsulation such as the KA and KT series, the outer diameter of the pick-up nozzle must be longer than that of the LED's light emitting area. i. e. $A > C$, and B shall be shorter than the width of the LED.

6. The size of the nozzle should be as large as possible if the tape is not involved.
7. The LEDs should not be exposed to an environment where high level of moisture or corrosive gases are present.
8. Prolonged reverse bias should be avoided, as it could cause metal migration, leading to an increase in leakage current or causing a short circuit.
9. Excess driving current and/or operating temperature higher than recommended conditions may result in severe light degradation or premature failure.
10. It is not recommended to assemble LEDs of different color or intensity bins together, as there may be perceivable color or intensity variation. Each bag contains parts from the same bin code. The bin code is printed on the bag's label as below.

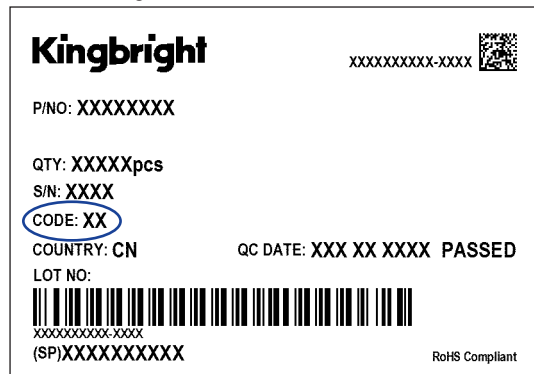

11. For the 1608 and 1005 series, an ESD ionizer should be used during SMT pick-and-place process to neutralize the charge and hence reduce electrostatic attraction.
12. Please do not apply stress directly to the LED during handling.
13. As silicone encapsulation is permeable to gases, some corrosive substances such as H₂S might corrode silver plating of leadframe. Special care should be taken if an LED with silicone encapsulation is to be used near such substances.
14. The LEDs should not be exposed to an environment where high level of moisture or corrosive gases are present.
15. Prolonged reverse bias should be avoided, as it could cause metal migration, leading to an increase in leakage current or causing a short circuit.

16. Choosing the right feeder for small SMD components:

16.1 When processing smaller SMD components (such as 0603, 1005, 1608, 1612, 1615, 2012), please use feeder with block to hold the part in place during cover tape removal, in order to prevent the component jumping or turning within the tape due to vibration or static cling.

16.2 Feeder without block is more suitable for larger size components (such as 3216, 3528).

16.3 Please insure the removed cover tape is properly threaded through the feeder as it is removed from the tape.

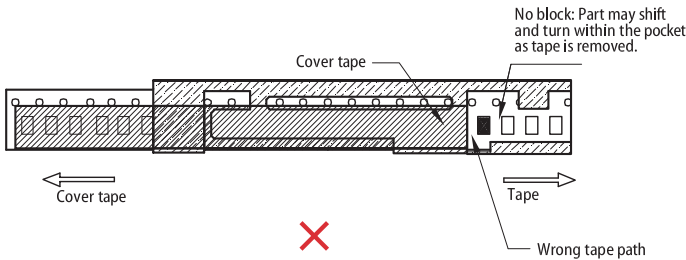
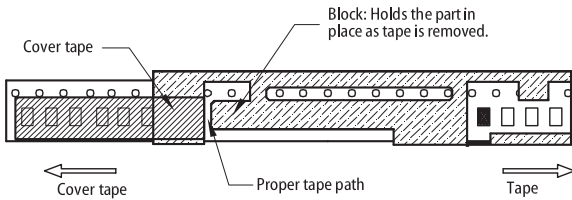

Storage Control For SMD Products

- Before a sealed moisture barrier bag (MBB) is opened, contained LEDs shall be kept in an environment with temperature below 40°C and humidity below 90% RH. MBB shall be kept sealed until LEDs contained in the bag are ready to be used. Once MBB is opened, it shall be stored in an environment with temperature range of 5°C~30°C and humidity below 60% RH.
- After the MBB has been opened, the LEDs should be used according to the floor life specified in the table below.

IPC/JEDEC J-STD-020 Moisture Sensitivity Levels

Level	Floor Life	
	Time	Conditions
1	Unlimited	≤30°C / 85% RH
2	1 year	≤30°C / 60% RH
2a	4 weeks	≤30°C / 60% RH
3	168 hours	≤30°C / 60% RH
4	72 hours	≤30°C / 60% RH
5	48 hours	≤30°C / 60% RH
5a	24 hours	≤30°C / 60% RH
6	Time on Label (TOL)	≤30°C / 60% RH

- If the Humidity Indicator Card (HIC)'s 10 % mark has changed, or the LEDs have not been used within the floor life specified, they should be baked with the following conditions to reset the floor life:

Type	Temperature	Humidity	Bake Time
When still in carrier tape	60±3°C	<5%RH	100H
When out of carrier tape	110°C	/	10H

* Not more than once

- Do not store LEDs in an environment where high humidity or acidic/basic chemicals are present, as they will degrade the LED's metallic surfaces.
- LED leadframe and soldering pads (cathode and anode) are plated with gold, tin, or other metals. Under long-term exposure to open air, the exposed pins and pads may become oxidized causing poor solderability. Therefore opened but unused parts must be stored in sealed containers. Suggest to store unused parts in the original moisture barrier bag.
- Moisture control for components already mounted on PCB: If the PCB will not undergo additional reflow soldering or high-temperature processes, then no special treatment is required for the mounted moisture-sensitive SMD components. If the PCB will undergo multiple reflow soldering or other high-temperature processes, including rework, then the SMD component's cumulative exposure time until the final high-temperature process must be controlled to within the specified time limit.

For Through-Hole Products

- Avoid continued exposure to the condensing moisture environment and keep the product away from rapid transitions in ambient temperature.
- LEDs should be stored with temperature ≤30°C and relative humidity < 60%.
- Product in the original sealed package is recommended to be assembled within 72 hours of opening. Product in opened package for more than a week should be baked for 30 (+10/-0) hours at 85 ~ 100°C.
- The LED leadframe surface is plated with silver. When the leadframe is stored under high-humidity environments, or exposed to certain chemical elements or gases, the surface may become discolored. Please maintain the cleanliness of the storage environment.
- If the storage conditions do not meet specification standards, the component pins may become oxidized requiring re-plating and re-sorting before use. Suggest customers consume LEDs as soon as possible, and avoid long-term storage of large inventories.

INDEX

DA04-11 SERIES	38	KP-2012 SERIES	10
DA56-11 SERIES	38	KP-2012F3C	47
DA56-51SURKWA	38	KP-2012P3C	49
DC-05 SERIES	39	KP-2012SF4C	47
DC-10 SERIES	40	KP-3216 SERIES	11
DE/2 SERIES	40	KP-3216P3C	49
DE/4 SERIES	40	KPA-1606 SERIES	13
DF-3 SERIES	40	KPA-2107L SERIES	4
DLA/6 SERIES	24	KPA-2107SURCK	13
DLC/6 SERIES	24	KPA-3010 SERIES	14
KA-2810A SERIES	14	KPA-3010F3C	47
KA-3021 SERIES	19	KPA-3010P3C	49
KA-3528 SERIES	19	KPB-3025 SERIES	17
KA-4008VBS-D	14	KPBA-3010 SERIES	16
KA-4040 SERIES	15	KPBD-3224 SERIES	18
KAA-3528ESGCT	18	KPBDA-3020 SERIES	18
KAA-3528RGS-K11-C8-CC	6	KPBL-3025 SERIES	17
KB-2400SYKW	41	KPD-3224 SERIES	12
KB-2450SYKW	41	KPED-3528 SERIES	12
KB-2500CGKD	41	KPFA-2507BRGC-11	5
KB-2550CGKD	41	KPFA-3010RGBC-11	6
KB-2655SEKW	41	KPG-0603 SERIES	6
KB-2700SYKW	41	KPG-1005 SERIES	7
KB-2755SYKW	41	KPG-1608 SERIES	7
KB-2855CGKD	41	KPGA-1602CGC-KA	13
KB-A100SURKW	41	KPGF-1011GBRC-120	5
KB-B100SURKW	41	KPH-1608 SERIES	8
KB-D100SURKW	41	KPHB-1608 SERIES	15
KCDX02 SERIES	31	KPHB-1608LVZGKSURKC	4
KCDX03 SERIES	32	KPHBM-2012 SERIES	16
KCDX04 SERIES	33	KPHBM-2012LVSURKZGKC	4
KCDX56 SERIES	34	KPHCM-2012 SERIES	9
KCPDX04 SERIES	35	KPHHS-1005 SERIES	7
KCPSX04 SERIES	35	KPHM-1608 SERIES	8
KCSA39 SERIES	33	KPL-3015 SERIES	10
KCSX02 SERIES	31	KPT-1608 SERIES	8
KCSX03 SERIES	32	KPT-1608LVZGCK	3
KCSX04 SERIES	33	KPT-2012 SERIES	10
KCSX56 SERIES	34	KPT-2012LVZGCK	3
KM-23 SERIES	17	KPT-3216 SERIES	11
KM-23-F SERIES	20	KPTB-1612 SERIES	15
KM2520F3C03	47	KPTB-1612L SERIES	4
KM2520XXX03 SERIES	20	KPTB-1615 SERIES	16
KM2520XXX09 SERIES	20	KPTBD-3216 SERIES	18
KP-1608 SERIES	9	KPTD-1608 SERIES	9
KP-1608F3C	47	KPTD-1608L SERIES	3
KP-1608P1C	49	KPTD-3216 SERIES	12
KP-1608SF4C	47	KPTF-1616RGBC-11	5

INDEX

KPTL-3216 SERIES	11	L-7104XXD-12V SERIES	29
KPTR-3216 SERIES	19	L-7104XXD-5V SERIES	29
KTDS-3534 SERIES	2	L-7104ZH/1 SERIES	42
KTDS-3536SY28Z4S	2	L-710A8CB/1 SERIES	42
L-1034 SERIES	25	L-7113 SERIES	23
L-113 SERIES	26	L-7113F3BT	48
L-1154 SERIES	21	L-7113F3C	48
L-115V SERIES	28	L-7113L SERIES	30
L-119 SERIES	29	L-7113P3C	50
L-13 SERIES	25	L-7113SF4C	48
L-130WCP/2 SERIES	45	L-7113SF6C	48
L-130WDT/1 SERIES	42	L-7113SF7C	48
L-1384AD/1 SERIES	42	L-7113XXD-12V SERIES	30
L-144 SERIES	25	L-7113XXD-5V SERIES	30
L-1503 SERIES	24	L-7143 SERIES	23
L-1503EB/2 SERIES	45	L-73EB/2 SERIES	45
L-150A9VS/1 SERIES	43	L-793 SERIES	24
L-1533BQ/1 SERIES	43	L-813 SERIES	24
L-154A4 SERIES	29	L-908A8 SERIES	21
L-1553 SERIES	26	L-914 SERIES	26
L-34 SERIES	22	L-9294 SERIES	22
L-34F3C	48	L-937 SERIES	27
L-34SF4C	48	PSA05-11SURKWA	39
L-3DP3BT	50	PSC05-11SURKWA	39
L-3V SERIES	28	SA08-11 SERIES	37
L-4060VH/2 SERIES	43	SA10-21 SERIES	37
L-4060XHA/3 SERIES	46	SA36-11 SERIES	36
L-424 SERIES	27	SA39-11 SERIES	36
L-43 SERIES	22	SA39-12 SERIES	36
L-47X SERIES	27	SA52-11 SERIES	36
L-483 SERIES	27	SA56-11 SERIES	37
L-5603 SERIES	25	SA56-21 SERIES	37
L-56B SERIES	30	SC08-11 SERIES	37
L-57 SERIES	28	SC36-11 SERIES	36
L-59 SERIES	28	SC39-11 SERIES	36
L-59BL/1 SERIES	43	SC52-11 SERIES	36
L-63 SERIES	23	SC56-11 SERIES	37
L-7104 SERIES	21	SC56-21 SERIES	37
L-7104EB/2 SERIES	44	TA07-11 SERIES	39
L-7104F3BT	48		
L-7104F3C	48		
L-7104GO/2 SERIES	44		
L-7104L SERIES	30		
L-7104MD/2 SERIES	44		
L-7104RS/1 SERIES	42		
L-7104RT/2 SERIES	44		
L-7104SA/3GD	46		
L-7104SB/4GD	46		